

**TECHNICAL MANUAL**

**OPERATOR'S, ORGANIZATIONAL, DIRECT SUPPORT  
AND GENERAL SUPPORT MAINTENANCE MANUAL**

**(INCLUDING REPAIR PARTS AND SPECIAL TOOLS LIST)**

**DC VOLTAGE CALIBRATOR**

**JOHN FLUKE MODELS  
332B/AF, AND 332B/D**

**This copy is a reprint which includes current pages  
from Changes 1 and 2.**

---

**HEADQUARTERS, DEPARTMENT OF THE ARMY**

**MARCH 1972**

**This manual is an authentication of the manufacturer's commercial literature which, through usage, has been found to cover the data required to operate and maintain this equipment. Since the manual was not prepared in accordance with military specifications, the format has not been structured to consider level of maintenance, nor to include a formal section on depot overhaul standards.**

**This manual contains copyrighted information that is printed with permission of John Fluke Manufacturing Company, Seattle, Washington.**

Technical Manual }  
 No. 9-4931-383-14-1 }

HEADQUARTERS  
 DEPARTMENT OF THE ARMY  
 Washington, D.C., 13 March 1972

**OPERATOR'S, ORGANIZATIONAL, DIRECT SUPPORT,  
 AND GENERAL SUPPORT MAINTENANCE MANUAL,  
 INCLUDING REPAIR PARTS AND SPECIAL TOOLS LIST:  
 DC VOLTAGE CALIBRATOR,  
 JOHN FLUKE MODELS 332B/AF AND 332B/D  
 (NSN 6625-00-150-6994)**

---

MODEL 332B/AF ADDENDA

TABLE OF CONTENTS

TITLE	PAGE
Introduction.....	1
Specifications .....	1
Operating Instructions .....	2
Theory of Operation .....	2
Maintenance.....	4
Calibration .....	5
Initial Calibration.....	7
Final Calibration.....	9
Troubleshooting.....	12
List of Replaceable Parts .....	15
Repair Parts List.....	65
List of Schematics .....	
A5A1 Reference Supply - 332B/AF-1083.....	
A4 Range Cal. - 332B/AF-1052.....	
A2 Sample String - 332B/AF-1051 .....	
A5A4 Chopper Amplifier - 332B/AF-1058 .....	
A7A1 Series Pass - 332B/AF-1061 .....	
A7A2 Preregulator - 332B/AF-1082 .....	

Change 1 i

## INTRODUCTION

The Model 332B/AF is a special version of the Model 332B. Subsequently, much of the information in the Model 332B Instruction Manual is directly applicable. Any differences in the Model 332B/AF are described in this Addenda.

## SPECIFICATIONS

Electrical and mechanical specifications are identical except as follows:

### Accuracy of Output

Accuracy specifications apply after one hour warm-up at standard reference conditions of 23 ( $\pm$ ) $^{\circ}$ C, up to 90% relative humidity, constant line voltage, and constant load.

### Relative Humidity

0 to 90%

### Input Power

115/230V ac  $\pm$ 10%, 50 to 60 or 400 Hz, single phase. Approximately 130 volt amperes under full load.

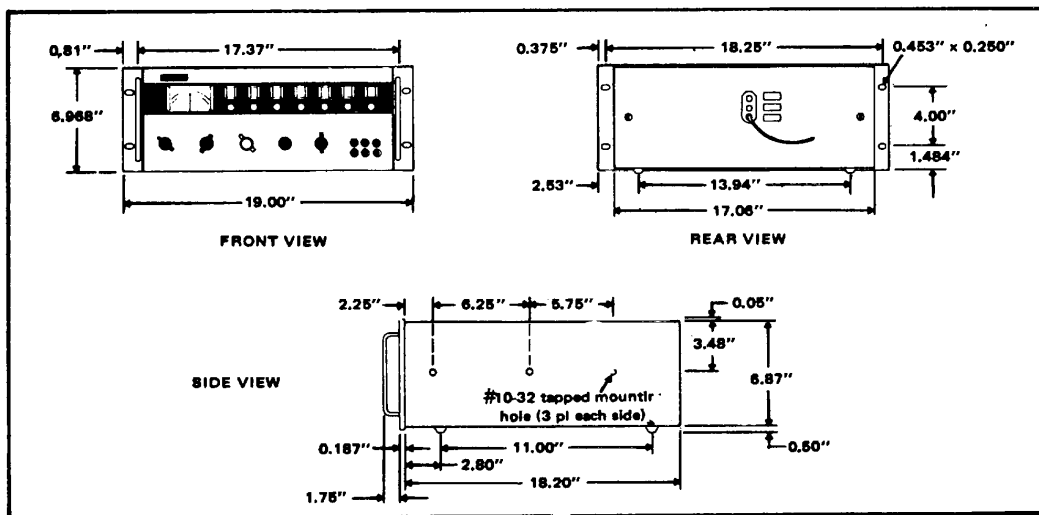

Figure 1. MODEL 332B/AF OUTLINE DRAWING

## OPERATING INSTRUCTIONS

Operation of the Model 332B/AF is identical to the Model 332B.

## THEORY OF OPERATION

The following descriptions are for assemblies peculiar to the Model 332B/AF. All other assemblies are described in Section III of the Model 332B manual. Schematic diagrams for the Model 332B/AF assemblies are located at the rear of this Addenda.

### Voltage Control Circuitry

**REFERENCE SUPPLY.** The master reference voltage for the instrument is produced in the A5A1 Reference Supply (Schematic No. 332B/AF-1083). This assembly consists of a +15V dc reference supply, an oven temperature regulator for the reference supply, and divider networks for compensation of offset voltages when the output is set to zero.

The Reference Supply is composed of differential amplifier U2 and zener reference amplifier A1. The reference amplifier is enclosed in an oven which maintains a constant temperature for environmental stability. Selection of the values of R7A and R7B scales the output of the Reference Supply to +15V dc. Variable resistor R9 allows adjustment of the resulting  $V_{REF}$  output. Temperature coefficient of the base/emitter voltage for A1 is accurately matched to the zener element through selection of R13. The resulting stable reference at the collector of A1 is applied to the noninverting input of U2. The other input to U2 receives an equivalent voltage from the divider composed of R14 and R15. Any change in  $V_{REF}$  is sensed at the base of A1 and the resulting amplified change applied to the noninverting input of U2. This change then alters the conduction of U2 such that  $V_{REF}$  is maintained at +15V dc. Constant operating temperature for the reference amplifier A1 is provided by the Oven Temperature Regulator Q1, U1, and oven R21. The series-pass regulator composed of Q1 and U1 establishes a constant voltage across the heater, R21. Any variations in heater voltage is sensed by U1 and amplified. The resulting output of U1 then alters the conduction of Q1 to maintain a constant voltage across the heater, R21. The heater element of R21 consists of a semiconductor material which has moderate conductivity at temperatures below a specific stabilization point and a marked decrease in conductivity as the temperature approaches the stabilization point. Application of a constant voltage to R21 provides a fast warm-up and a much more stable operating temperature. The dividers composed of R1

through R6 provide a bias voltage to one input of the A5A4 Chopper Amplifier. R2, R4, and R6 are adjusted to compensate for offsets in the 10V, 100V, and 1000V ranges when the output is set to zero.

**SAMPLE STRING.** The A2 Sample String (Drawing No. 332B/AF-1051) together with the selected range resistor in the A4 Range Cal forms a resistive divider whose ratio is controlled by the front panel decade dials. The output voltage of the Sample String is proportional to the reference voltage multiplied by the ratio of the Sample String resistance to the A4 range resistance.

**RANGE RESISTORS.** The A4 Range Cal (Drawing No. 332B/AF-1052) provides three separate adjustable range resistors. These resistors together with the A2 Sample String form a resistive divider which determine the output voltage of the instrument.

**CHOPPER AMPLIFIER.** The A5A4 Chopper Amplifier (Drawing No. 332B/AF-1058) compares low frequency and dc control signals from the A2 Sample String output to the +SENSE terminal voltage and amplifies any difference. The circuitry consists of an input filter, a MOSFET chopper, an operational amplifier, a synchronous demodulator, an output filter, and a multivibrator.

Low frequency and dc control signals at terminal 6 are passed through the input filter C2, R1, and C3 to reject frequencies above 30 Hz. The MOSFET chopper Q1 modulates the signal appearing at the junction of its drain and R2. C4 couples the resultant to the gate of JFET Q2. The output signal at the drain of Q2 is then amplified by the operational amplifier IC1, which has a gain of approximately 420. The paraphase amplifier Q3 amplifies the output of IC1 and provides two equal amplitude, but 180° out-of-phase signals. The collector signal of Q3 is coupled by C16 to the shunt demodulator Q4. The resulting demodulated signal appearing at the junction of C17 and R24 is filtered by R24, R26 and C18, leaving only the amplified dc and low frequency signals. The emitter signal of Q3 is applied through C14, R21, C15, R25, R23, and C22 to C18, where it is used to cancel any chopper ripple at 270 Hz.

The 270 Hz multivibrator is formed by Q6, Q7 and associated timing networks, in addition to a driver Q5. Variable resistor R43 adjusts the level of the signal applied to the driver Q5, and subsequently the output signal applied to the gate of Q1. The collector signal of Q5 is applied to the drain of Q1 to compensate for spikes coupled between

the gate and drain. Variable resistor R34 provides adjustment of the compensation signal. An output signal at the collector of Q7 is applied to the base of Q4, which synchronously demodulates the Chopper Amplifier output.

**SERIES PASS.** The A7A1 Series Pass (Drawing No. 332B/AF-1061) contains the series-pass transistors which control the output voltage. It also contains a voltage controlled oscillator (VCO) and control amplifiers which are part of the preregulator, a power supply, and an automatic "crowbar" driver.

The power supply composed essentially of CR1 through CR4 produces the required operating voltages for the Series Pass circuitry. AC voltage at terminals 8 and 9 is rectified by CR1 through CR4 to provide an unfiltered positive voltage. This voltage is isolated by CR5 and filtered by C2 to provide a +150V dc operating voltage for the series-pass transistors. The voltage divider of R1 through R3 and zener CR6 produces a clipped, full-wave rectified 16V synchronizing signal for the VCO.

Output voltage of the instrument is established and maintained by the series-pass transistors, Q1 through Q8. The transistors Q1 through Q7 are normally saturated and Q8 is absorbing the total voltage required to maintain the output of the instrument. However, when the output level or load current is changed and the voltage across Q8 exceeds 150V, Q1 through Q7 absorb the additional voltage. The preregulator circuitry then reduces the output of the A7 H.V. Mother Board until the voltage across Q8 is less than 150V. When this condition is reached, Q1 through Q7 again saturate and Q8 absorbs the total regulation voltage.

The automatic "crowbar" consisting of Q10 monitors the total voltage drop across the series-pass transistors. Load or output changes that cause the voltage across the series-pass to exceed 225V will cause Q10 to conduct. Its conduction energizes K2 on the A7 H.V. Motor Board and places a load across the high voltage rectifier, thus limiting the voltage across the series-pass transistors.

Unijunction transistor Q9 and C3, L3, R37, CR18, R35, and CR19 form a VCO which furnishes turn off pulses to the preregulator circuitry. This VCO is synchronized to the ac line zero crossing through amplifiers Q11 and Q12.

A clipped 16V pulse is rectified by CR32 and C5 to provide operating voltage for the base of the VCO, Q9. This voltage is clamped to zero during the ac line zero interval by amplifiers Q11 and Q12. The divider composed of R36 and R42 provides a sample of the

clipped 16V pulse at the base of Q12. When the pulse is at 0V, Q12 produces an amplified positive pulse at its collector. This pulse is differentiated by C4 and R41 and the resulting positive spike momentarily turns on Q11. Conduction of Q11 clamps the output of rectifier CR32, C5 to zero, thus synchronizing the output of Q9 to the ac line zero crossing. The output pulses from Q9 are dependent upon the voltage charge on C3. The voltage is sensed across Q8 through the divider consisting of L3, R37, R35, CR18, and CR19. If this voltage increases, Q9 will produce a preregulator turn off pulse earlier in the ac line cycle, thus reducing the ac power available to the A7 H.V. Mother Board. Conversely, should the voltage across Q8 decrease, the ac power to the A7 H.V. Mother Board is increased.

**PREREGULATOR.** The A7A2 Preregulator (Drawing No. 332B/AF-1082) controls the ac power supplied to the instrument by passing only enough power to the A7 H.V. Mother Board to meet the output load requirement. It consists of a  $\pm V$  supply, a relay power supply, preregulator control drivers, a preregulator bridge, and a current limiter.

$\pm V$  and +10V dc operating voltages are produced for the A7A2 Preregulator by the rectifier CR1 through CR4 and associated components. A 10V ac input is applied to CR1 through CR4. The dc output at the junction of CR2 and CR4 is filtered by C3 to provide a -V operating voltage. The dc voltage at the junction of CR3 and CR1 is heavily loaded by R1 to provide an unfiltered +V operating voltage. This voltage is also isolated through CR5 and filtered by C4 to provide a +10V dc operating voltage.

Operating voltage for relay K1, which supplies ac voltage to the preregulator bridge, is produced by bridge rectifier CR6 through CR9 and K2. AC return for the bridge rectifier is provided through the contacts of K2. This relay is energized only in the OPR mode by a control voltage from the A5A2 Series Pass Driver. The A5A2 Series Pass Driver automatically removes the control voltage from K2 should a VOLTAGE TRIP occur, thus removing ac power to the preregulator bridge and establishing a STDBY condition.

The circuitry consisting of Q2 through Q9 controls the conduction of the preregulator bridge attenuator, Q1. Input pulses from the VCO in the A7A1 Series Pass are supplied to terminal 14 and the base of Q7. The first pulse turns on Q7 and Q6, which through regenerative action, saturate. This condition turns off Q5 and causes Q4 and Q8 to also turn off. Q9 is subsequently turned on by the -V collector voltage of Q8 and provides a negative voltage at the base of Q2.

This condition turns off Q2 and also Q1, thus causing the preregulator bridge of CR10 through CR13 and Q1 to provide maximum attenuation to the ac voltage applied to the A7 H.V. Mother Board. When the ac line passes through zero, the 0V, +V condition at the emitter of Q6 causes it to turn off and also turns off Q7. This condition reverses the previously described state of each transistor and the preregulator bridge again passes the ac line voltage to the A7 H.V. Mother Board.

AC line voltage applied to T2 and subsequently the A7 H.V. Mother Board is controlled through the preregulator bridge consisting of CR10 through CR13 and Q1. The previously described circuitry of Q2 through Q9 controls conduction of Q1. Diodes CR10 through CR13 provide a unidirectional current through Q1. Positive alternations are passed by CR10 and CR13. CR12 and CR11 pass negative alternations. Should Q1 be cut off, C6 and R5 provide a dynamic load for the bridge. Overload current protection for Q1 is provided through divider R2, R8, and R9 and Q3. Should the current through Q1 exceed 17 amperes, the voltage at the base of Q3 turns it on and causes Q6 to saturate. This condition causes Q1 to be cut off, thus limiting the current through the preregulator bridge.

**MAINTENANCE**

In general, the procedures given in Section 4 of the Model 332B manual are applicable for servicing the

Model 332B/AF. Any differences are described in the following paragraphs.

**Unique Maintenance Procedures**

The information regarding Shielded Capacitors is not applicable to the Model 332B/AF.

**Performance Tests**

**LINE REGULATION.** This test is applicable to the Model 332B/AF. However, the tests are made with the line voltage settings of 100, 117, and 130V ac and the resulting output voltage change should not exceed the tolerance specified in Figure 2. Check at 60 and 400 Hz.

**LOAD REGULATION.** These checks are applicable to the Model 332B/AF except that they are performed at a nominal, fixed line voltage of 117V ac only. Refer to Figure 3 for specification limits. Check at 60 and 400 Hz.

**RIPPLE.** The ripple test determines if ac component superimposed on the dc output of the Model 332B is within specified limits.

- a. Connect the preamplifier to the OUTPUT terminals of the Model 332B/AF. Connect the Model 931 RMS Voltmeter to the output of the preamplifier.

RANGE	READOUT	LOAD (50 ma)	SPEC.
10	1	20Ω	10 uv
10	10	200Ω	20 uv
100	10	200Ω	20 uv
100	100	2000Ω	200uv
1000	100	2000Ω	200uv
1000	1000	20, 000Ω	2.0 mv

Figure 2. CONTROL SETTINGS, LOAD REQUIREMENTS, AND LIMITS FOR LINE REGULATION

RANGE	READOUT	LOAD(50 ma)	SPEC.
10	1	20Ω	ΔE< 10uv
10	10	200Ω	ΔE< 20 uv
100	10	200Ω	ΔE< 20 uv
100	100	2000Ω	ΔE< 200 uv
1000	100	2000Ω	ΔE< 200 uv
1000	1000	20, 000Ω	ΔE< 2.0 mv

Figure 3. CONTROL SETTINGS, LOAD REQUIREMENTS, AND LIMITS FOR LOAD REGULATION

- b. Set the front panel controls of the Model 332B/AF as follows:

POWER	STDBY/RESET
METER	CURRENT
RANGE	10
Readout Dials	All Zero
VOLTAGE TRIP	1000
VERNIER	Clockwise
CURRENT LIMIT	Clockwise (60)

- c. With the autotransformer set to nominal line voltage (117V ac), set the POWER switch to OPR. The ripple output on the Model 332B/AF should not exceed 20 microvolts.

**NOTE!**

**Ripple indication is via 1000X preamplifier.**

- d. Set the readout dials to 10 volts. The ripple output on the Model 332B/AF should not exceed 20 microvolts rms.
- e. Connect the 200-ohm load resistor to the OUTPUT terminals. The ripple output on the Model 332B/AF should not exceed 20 microvolts rms. Disconnect the load resistor.
- f. Set the readout dials to zero, and set the RANGE switch to 100. The ripple output on the Model 332B/AF should not exceed 30 microvolts rms.
- g. Set the readout dials to 100 volts. The ripple output on the Model 332B/AF should not exceed 30 microvolts rms.
- h. Connect the 2, 000-ohm load resistor to the OUTPUT terminals. The ripple output on the Model 332B/AF should not exceed 30 microvolts rms. Disconnect the load resistors.
- i. Set the readout dials to zero, and set the RANGE switch to 1000. The ripple output on the Model 332B/AF should not exceed 40 microvolts rms.
- j. Set the readout dials for 1000V. The ripple output on the Model 332/BAF should not exceed 40 microvolts rms.
- k. Connect a 20k-ohm load resistor to the OUTPUT terminals. The ripple output on the Model 332B/AF should not exceed 40 microvolts rms. Disconnect the load resistor.

CURRENT LIMIT. This check is applicable to the Model 332B/AF. However, the range of the current control should be from 0.5 to 60 milliamps.

**CALIBRATION**

Refer to TB 9-4931-383-50 for Calibration Procedure. Paragraph 4-36 through 4-56 pertains to the JF 332B/D Model and should not be used when calibrating the JF 332B/AF.



**Pages 6-11 have been deleted.**

**Pages 6-11**

THIS PAGE CURRENTLY NOT AVAILABLE FOR DIGITIZATION

PAGE 12

tion point. When correctly adjusted the waveform should look like Figure 14.

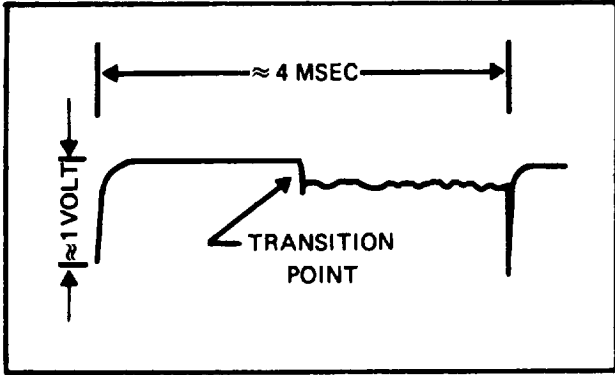

Figure 14. CHOPPER WAVEFORM

- e. Replace the chopper board in the instrument.

To check amplifier response:

- a. Connect the oscilloscope with a 10X isolation probe between Pins 14 (common) and 15 (input) of the Series Pass P/C Assembly. Set the oscilloscope sweep speed to 1 millisecond/cm and vertical sensitivity to 1 volt/cm.
- b. Set the POWER switch to STDBY/RESET. Positive going pulses of 1.0 to 2.0 volts peak-to-peak should be observed.
- c. Set POWER switch to ON position. The pulses observed in step b. should disappear.
- d. Set the output of a laboratory power supply to 5.5V dc.
- e. With 332B/AF POWER switch in ON position, connect the lab supply to the corresponding OUTPUT terminals of the 332B/AF.
- f. Set 332B/AF controls as follows and observe unijunction pulses:

Range	Dialed Voltage	Unijunction Pulses
10V	5.000000	Should appear
10V	6.000000	Should disappear
100V	05.00000	Should appear
100V	06.00000	Should disappear
1000V	005.0000	Should appear
1000V	006.0000	Should disappear

### Pre-Regulator

This check applies to the 332B/AF. However, it should be performed as follows:

- a. Set the POWER switch to OFF. Install the pre-Regulator P/C Assembly.
- b. Set the instrument front panel controls as follows:

POWER	OFF
RANGE	1000
VOLTAGE TRIP	1000
VERNIER	Maximum Clockwise
CURRENT LIMIT	Maximum Clockwise

- c. Connect the oscilloscope power plug to the ac line via a line isolator (two-to-three wire adapter). The oscilloscope must be operated ungrounded when observing pre-regulator waveforms.
- d. Connect the oscilloscope common to the emitter (blue) of Q1 and connect the input to the base (yellow). (Q1 is the stud-mounted power transistor). Set the vertical input to DC, sweep speed to 2 millisecond/cm and the vertical sensitivity to 0.5 volt/cm.
- e. Set the readout dials to 50.0000 and the POWER switch to STDBY/RESET. The oscilloscope waveform should appear as shown in Figure 4-16 of the 332B/332D manual. (Figure 4-16 should read 0.5 volts/cm.)
- f. Set the POWER switch to ON. The oscilloscope waveform should appear as shown in Figure 4-17 of the 332B/332D manual. (Figure 4-17 should read 0.5 volts/cm.)
- g. Set POWER switch to STDBY/RESET and remove oscilloscope connections. Short out the interlocks using nylon blocks. Set POWER switch to ON. Voltmeter of 332B/AF should indicate  $50 \pm 10$  volts.
- h. Set RANGE switch to 10 volt range. Voltmeter should indicate  $5 \pm 1$  volt:
- i. Set RANGE switch to 1000 volt range. Voltmeter should indicate  $500 \pm 100$  volts. Set POWER switch to STDBY/RESET.

- j. Connect the oscilloscope across the 50 watt zener diode on the pre-regulator assembly. Connect oscilloscope "positive" input to cathode; connect "negative" input to the anode; use a 10X probe.
- k. Set decades for 1100 volt output and set CURRENT LIMIT to 60 mA. Apply full load, 60 mA.
- l. Set oscilloscope sensitivity to 50V/cm and sweep speed to 2 ms/cm.
- m. Set line voltage to 115V ac, 60 Hz. The waveform observed on the oscilloscope should appear as in Figure 15A and should not exceed 150 volts peak.
- n. Set line voltage to 100V ac, 60 Hz. The waveform observed on the oscilloscope should appear as in Figure 15B and should not exceed 150 volts peak.
- o. Set line voltage to 130V ac, 60 Hz. The waveform observed on the oscilloscope should appear as in Figure 15C and should not exceed 150 volts peak.
- p. Remove oscilloscope connections.

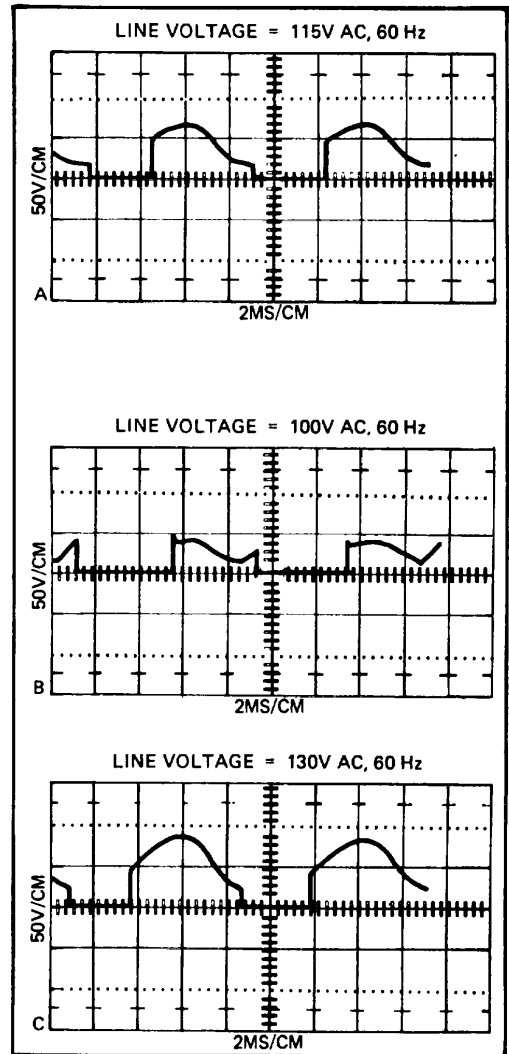

**Series Pass Element**

This check is applicable to the 332B/AF. However, it should be performed as follows:

- a. Set the line voltage to 100V ac and set readout dials to all zeros. Connect a voltmeter between the collector of Q1 and the emitter of Q8 on the Pass Element Assembly. This voltage should read less than 85V dc.
- b. Set the line voltage and 332B/AF controls as in Figure 16 and measure the voltage between the collector and emitter of Q8. The voltages should be within the specified limits.
- c. Connect the voltmeter across the OUTPUT terminals of the 332B/AF. Set the 332B/AF for the following outputs on the 1000 volt range and short the OUTPUT terminals at each setting. The output should return to normal upon removal of the short.

OUTPUTS: 100, 300, 600, 900, 1100 volts.

Range	Output	Load	Line Voltage	Limits Across Q8	
				Min.	Max.
10	0	0	100	70	100
10	0	0	130	65	90
1000	1100	60 mA	100	40	55
1000	1100	60 mA	130	40	55

Figure 15. WAVEFORMS ACROSS ZENER DIODE

Range	Output	Load	Line Voltage	Limits Across Q8	
				Voltage Min.	Max.
10	0	0	100	70	100
10	0	0	130	65	90
1000	1100	60mA	100	40	55
1000	1100	60mA	130	40	55

Figure 16. SERIES PASS ELEMENT VOLTAGE CHECKS

## LIST OF REPLACEABLE PARTS

INTRODUCTION. This section contains complete descriptions of those parts one might normally expect to replace during the life of the instrument. The first listing is a breakdown of all of the major assemblies in the instrument. Subsequent listings itemize the components in each assembly. Every listing is accompanied by an illustration identifying each component in the listing. Assemblies and subassemblies are identified by a reference designation beginning with the letter A, (e.g. A1, etc.). Components are identified by the schematic diagram reference designation (e.g. R1, C107, DS1). Parts not appearing on the schematic diagram are numbered consecutively throughout the parts list with a whole number in arrow call-out illustrations and are identified by index number only in grid illustration. Flagnotes are used throughout the parts list and refer to ordering explanations. The flagnote explanations appear at the end of the parts list in which they are listed.

### Columnar Information

- a. The REF DESIG column indexes the item description to the associated illustration. In general the reference designations are listed under each assembly in alpha-numeric order. Sub-assemblies of minor proportions are sometimes listed with the assembly of which they are a part. In this case, the reference designations for the components of the sub-assembly may appear out of order.
- b. The INDEX NO. column lists co-ordinates which locate the designated part on the associated illustrations.
- c. The DESCRIPTION column describes the salient characteristics of the component. Indention of the description indicates the relationship to other assemblies, components, etc. In many cases it is necessary to abbreviate in this column. For abbreviations and symbols used, see Appendix B.
- d. The six-digit or the ten-digit part number by which the item is identified at the John Fluke Mfg. Co. Inc. is listed in the STOCK NO. column. Use this number when ordering parts from the factory or authorized representatives.
- e. The Federal Supply Code for the item manufacturer is listed in the MFR column. An abbreviated list of Federal Supply Codes is included in the Appendix.
- f. The part number which uniquely identifies the item to the original manufacturer is listed in the MFR PART NO column. If a component must be ordered by description, the type number is listed.
- g. The TOT QTY column lists the total quantity of the item used in the instrument. Second and subsequent listing of the same item are referenced to the first listing with the abbreviation REF. In case of optional sub-assemblies, plug ins, etc. that are not always part of the instrument, the TOT QTY column lists the total quantity of the item in that particular assembly.
- h. Entries in the REC QTY column indicate the recommended number of spare parts necessary to support one to five instruments for a period of two years. This list presumes an availability of common electronic parts at the maintenance site. For maintenance for one year or more at an isolated site, it is recommended that at least one of every part in the instrument be stocked.
- i. The USE CODE column identifies certain parts which have been added, deleted or modified during the production of the instrument. Each part for which a Use Code has been assigned may be identified with a particular instrument serial number by consulting the Serial Number Effectivity List in paragraph 5-8. As Use Codes are added to the list, the TOT QTY column listings are changed to reflect the most current information. Sometimes when a part is changed, the new part can and should be used as a replacement for the original part. In this event a parenthetical note is added in the DESCRIPTION column.

**How To Obtain Parts**

To obtain replacement parts, find the manufacturer's part number and description in this manual and then refer to the appropriate Repair Parts and Special Tools List (RPSTL) TH. In the RPSTL, find the assembly or subassembly first and then the description which corresponds with that in this manual. Under the description in the RPSTL find cth. manufacturer's part number, and then order the part by the listed Federal Stock Number. If the part is not listed in the RPSTL, it should be requisitioned from the NICP in accordance with AR 725-50.

**Serial Number Effectivity**

A Use Code column is provided to identify certain parts that have been added, deleted, or modified during production of the Model 332B/AF. Each part for which a use code has been assigned may be identified with a particular instrument serial number by consulting the Use Code Effectivity List below. All parts with no code are used on all instruments with serial numbers above 123.

REF DESIG	INDEX NO	DESCRIPTION	STOCK NO	MFR	MFR PART NO	TOT QTY	REC QTY	USE CODE
		<b>DC VOLTAGE STANDARD</b> <b>Figure 5-1</b>	332B/AF					
A1		Capacitor P/C Assembly (See Figure 5-2)	1702-239343 (332B-4055)	89538	1702-239343	1		
A2		Sample String P/C Assembly (See Figure 5-3)	1702-314849	89536	1702-314849	1		
A3		Capacitor Switch P/C Assembly (See Figure 5-4)	1702-227603 (335A-4092)	89536	1702-227603	1		
A4		Range Calibration P/C Assembly (See Figure 5-5)	1702-314865 (332B/AF- 4065)	89536	1702-314865	1		
A5		Main Mother Board P/C Assembly (See Figure 5-6)	1702-219238 (335A-4064)	89536	1702-219238	1		
A5A1		Reference Supply P/C Assembly (See Figure 5-7)	1702-314864 (332B/AF- 4083)	89536	1702-314864	1		
A5A2		Series Pass Driver P/C Assembly (See Figure 5-8)	1702-219154 (335A-4056)	89536	1702-219154	1		
A5A3		Differential Amplifier P/C Assembly (See Figure 5-9)	1702-219162 (335A-4057)	89536	1702-219162	1		
A5A4		Chopper Amplifier P/C Assembly (See Figure 5-10)	1702-314872 (332B/AF- 4004)	89536	1702-314872	1		
A5A5		Auxiliary Power Supply P/C Assembly (See Figure 5-11)	1702-219188 (335A-4059)	89536	1702-219188	1		
A5A6		Current Limiter P/C Assembly (See Figure 5-12)	1702-219196 (335A-4060)	89536	1702-219196	1		
A6		Time Delay P/C Assembly (See Figure 5-13)	1702-192260 (332A-420)	89536	1702-192660	1		
A7		High Voltage Mother Board P/C Assembly (See Figure 5-14)	1702-314831 (332B/AF- 4056)	89536	1702-314831	1		
A7A1		Series Pass Element P/C Assembly (See Figure 5-15)	1702-314823 (332B/AF- 4061)	89536	1702-314823	1		
A7A2		Preregulator P/C Assembly (See Figure 5-16)	1702-314815 (332B/AF- 4082)	89536	1702-314815	1		
A8		Extender P/C Board	1702-187344 (332A-415)	89538	1702-187344	1		
C1		Cap, oil, 4 uf $\pm$ 10%, 1, 200v	1505-183541	01884	CMLE405K12	1		
C2		Cap, cer, 0.01 uf, gmV, 1, 600v (located on C1)	1501-106930	71590	DD16-103	2		
C9		Cap, cer, 0.005 uf $\pm$ 20%, 3, 000v	1501-188003	71590	DD30-502	1		
C4		Cap, plstc, 0.1 uf $\pm$ 10%, 1, 500v	1507-234260	96733	C-60232A	2		

REF DESIG	INDEX NO	DESCRIPTION	STOCK NO	MFR	MFR PART NO	TOT QTY	REC QTY	USE CODE
C5		Cap, plstc, 0.1 uf ± 10%, 1, 500v	1507-234260	96733	C-60232A	REF		
C6		Cap, poly, .10 uf ± 10%, 400v	1512-289744	73445	C280CFA100K	2		
C7		Cap, poly, .10 uf ± 10%, 400v	1512-289744	73445	C280CFA100K	REF		
CF1		Diode, silicon, 1 amp, 100 piv	4802-116111	05277	1N4817	55	5	
CR2		Diode, silicon, 1 amp, 600 piv	4802-112383	05277	1N4822	48	5	
CR3		Diode, silicon, 1 amp. 600 piv	4802-112383	05277	1N4822	REF		
DS1		Lamp, Incandescent, 28v	3901-175265	89730	757	5	5	
DS2		Lamp, incandescent, 28v	3901-175265	89730	757	REF		
DS3		Lamp, incandescent, 28v	3901-175265	89730	757	REF		
DS4		Lamp, incandescent, 28v	3901-175265	89730	757	REF		
DS5		Lamp, incandescent, 28v	3901-175265	89730	757	REF		
F1		Fuse, Type MDL, slow blow, 1/4 amp, 250v	5101-166306	71400	Type MDL	1	5	
F2		Fuse, Type MDA, slow blow, 3 amp, 250v (For 115v operation)	5101-109280	71400	Type MDA	1	5	
F2		Fuse, Type MDX, slow blow, 1-1/2 amp, 250v (For 230v operation)	5101-109231	71400	Type MDX	1	5	
J1		Binding post, red, OUTPUT	2811-149856	58474	BHB10208G22	2		
J2		Binding post, black, OUTPUT	2811-149864	58474	BHB10208G21	2		
J3		Binding post, red, SENSE	2811-149856	58474	BHB10208G22	REF		
J4		Binding post, black, SENSE	2811-149864	58474	BHB10208G21	REF		
J5		Binding post, GROUND	2811-155911	58474	GP30NC	1		
J6		Binding post, blue, GUARD	2811-233833	58474	DF31BLC	1		
K1		Relay, armature. 115 vac, dpdt	4504-196675	89536	4504-196675	1		J
K1		Relay. armature, 115 vac. dpdt	4504-148940	73949	A410-060713- 00	1		K
M1		Meter, 0-100 ua, 325Ω	2901-225490	89536	2901-225490	1		
R1		Res, met flm, 100k ± 1%, 1/2w (mounted on S3)	4705-151316	75042	Type CEC-TO	2		
R2		Res, met flm, 1M ± 1%, 1/2w (mounted on S3)	4705-161075	75042	Type CEC-TO	1		
R3		Res, car flm, 5M ± 1%, 1w	4703-107458	75042	Type C13	2		
R4		Res, car flm, 5M ± 1%, 1w	4703-107458	75042	Type C13	REF		



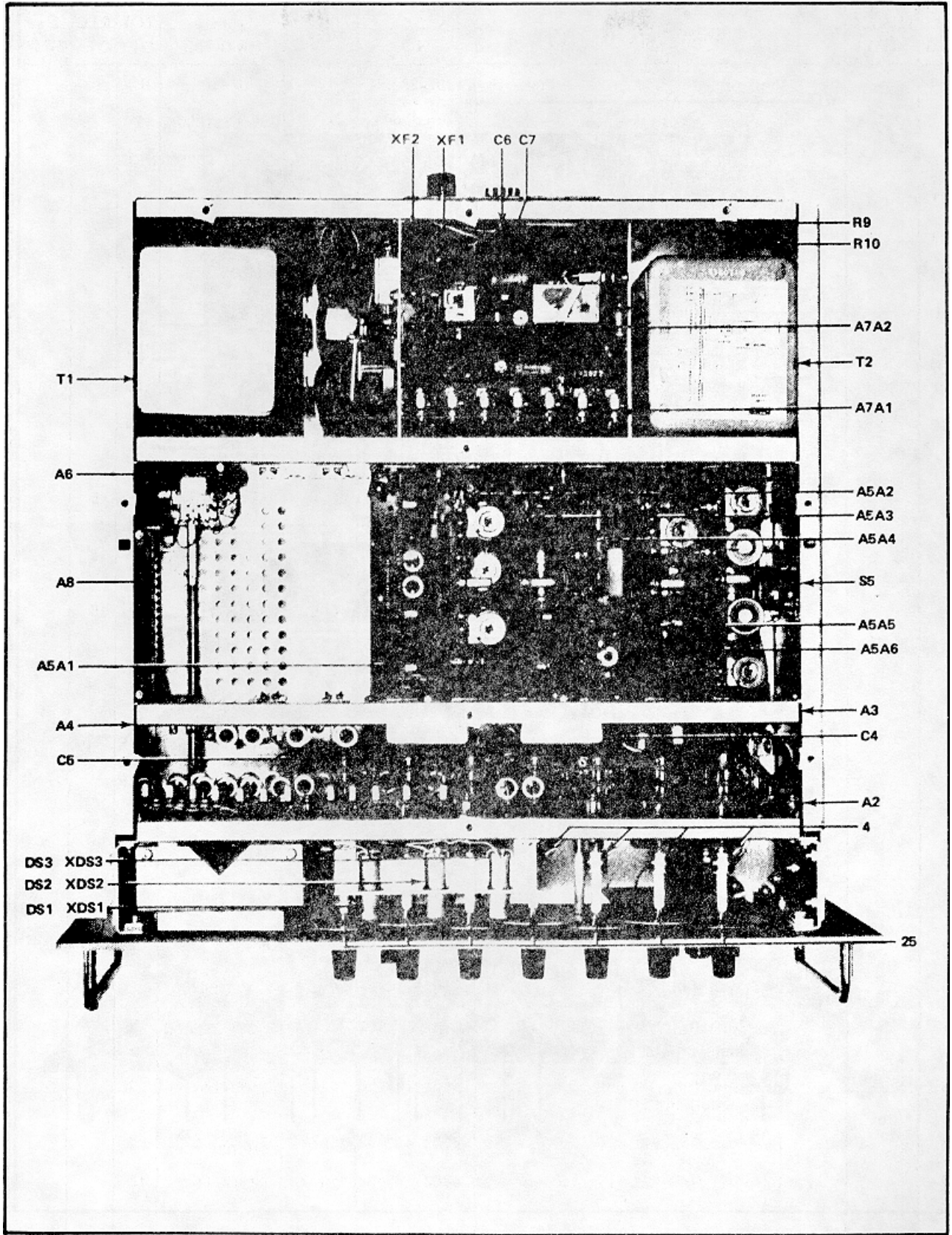

Figure 5-1. DC VOLTAGE STANDARD (Sheet 1 of 3)

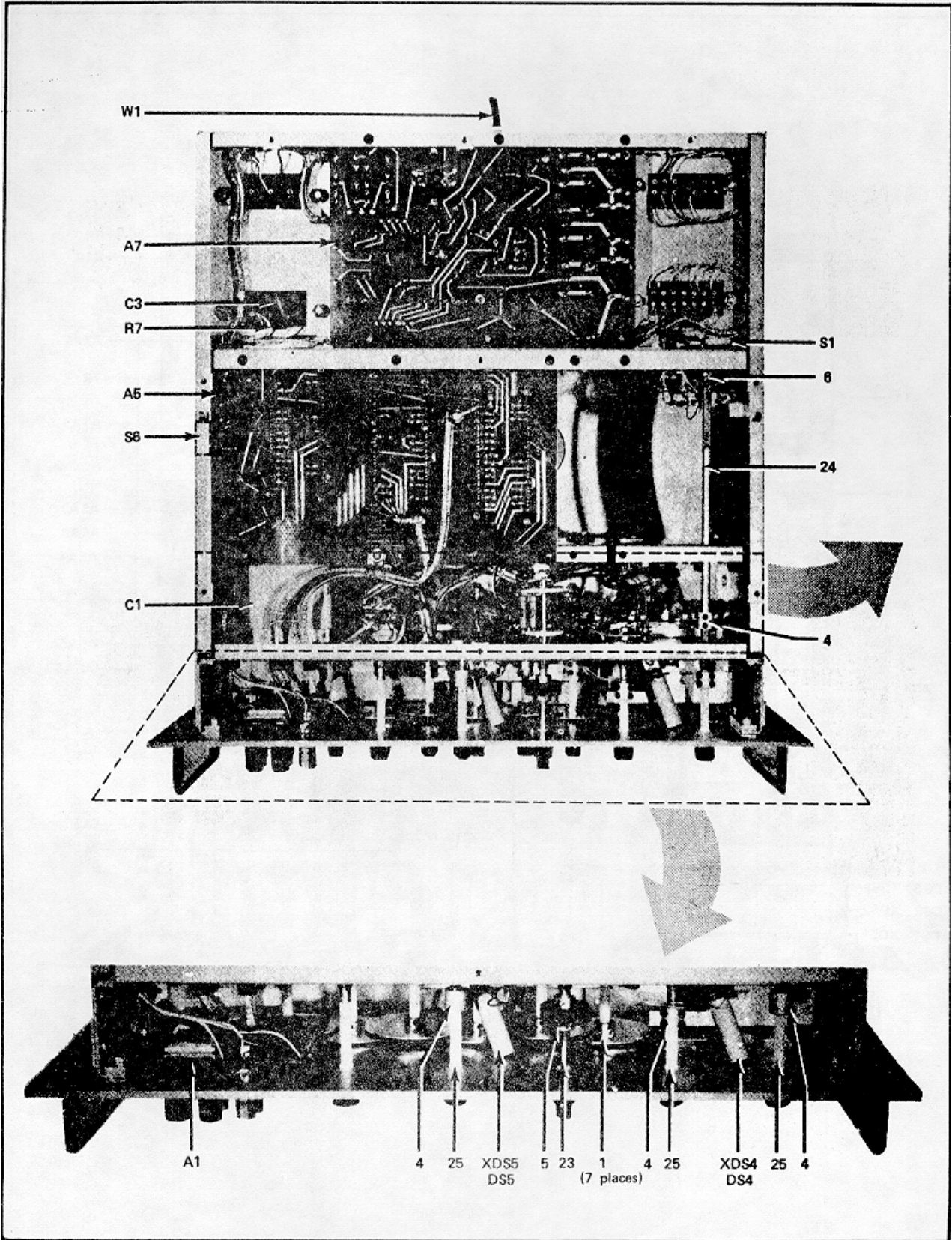

Figure 5-1. DC VOLTAGE STANDARD (Sheet 2 of 3)

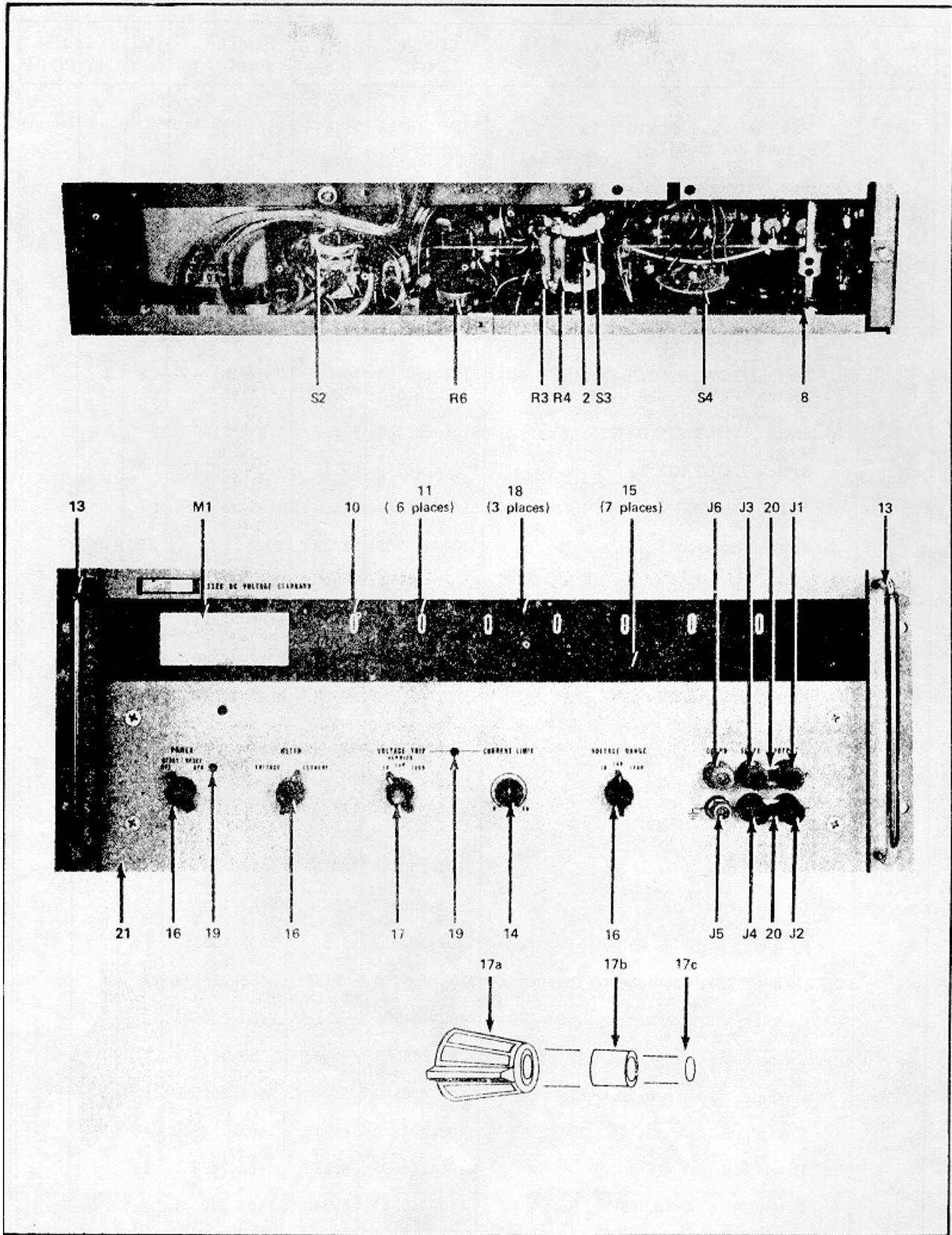

Figure 5-1. DC VOLTAGE STANDARD (Sheet 3 of 3)

REF DESIG	INDEX NO	DESCRIPTION	STOCK NO	MFR	MFR PART NO	TOT QTY	REC QTY	USE CODE
R5		Res, var, ww, 5k $\pm$ 10%, 5w (mounted on S3)	4702-219758	71450	Type AW	1		
R6		Res, var, ww, 300 $\Omega$ $\pm$ 10%, 5w	4702-219741	71450	Type AW	1		
R7		Res, comp. 1k $\pm$ 10%, 1/2w	4704-108563	01121	EB1021	4		
R8		Res, ww, 500 $\Omega$ $\pm$ 5%, 25w	4706-183533	14193	Type MC250	1		
R9		Res, ww, 100k $\pm$ 1%, 10w	4706-177121	14193	Type SP1127	2		
R10		Res, ww, 100k $\pm$ 1%, 10w	4706-177121	14193	Type SP1127	REF		
S1		Switch, POWER, STDBY/RESET wafer	5107-187864	76854	Type HC	1		
		Switch, POWER, OPR wafer	5107-187872	76854	248214HC	1		
S2		Switch, VOLTAGE RANGE, rotary	5105-237305	89536	5105-237305	1		
S3		Switch, VOLTAGE TRIP, rotary	5105-240739	89536	5105-240739	1		
S4		Switch, METER, rotary	5105-187146	89536	5105-187146	1		
S5		Switch, interlock	5104-187708	91929	V3L-78	2		
S6		Switch, interlock	5104-187708	91929	V3L-78	REF		
T1		Transformer, power	5602-222315	89536	5602-222315	1		
T2		Transformer, high voltage	5602-222307	89536	5602-222307	1		
W1		Line cord	6005-102822	89536	6005-102822	1		
XDS1 thru XDS3		Holder, lamp	2110-100131	95263	7-14	3		
XDS4, XDS5		Holder, lamp	2110-103523	72619	7-08	2		
XF1 XF2		Holder, fuse	2102-160846	75915	342004	2		
1		Coupler, dial	3153-130252	89536	3153-130252	7		
2		Coupler, R5 to S3	2402-193557	89536	2402-193557	1		
3		Coupler, Digit Switches to detents	3153-226779	89536	3153-226779	7		
4		Coupler, Digit Switches, S1, S4, R6	2402-104505	89536	2402-104505	11		
5		Coupler, S3	3153-246058	89536	3153-246058	1		
6		Coupler, S1 shaft to S1 wafer	2402-200592	89536	2402-200592	1		
7		Cover (not illustrated)	1402-228809	89536	1402-228809	1		
8		Detent, S1	5108-240895	89536	5108-240895	41		
9		Detent, Digit Switches	5108-240887	89536	5108-240887	7		

REF DESIG	INDEX NO	DESCRIPTION	STOCK NO	MFR	MFR PART NO	TOT QTY	REC QTY	USE CODE
10		Dial, 0-10	2506-236984	89536	2506-236984	1		
11		Dial, 0-X	2506-236976	89536	2506-236976	6		
12		Foot, rubber (not illustrated)	2819-103309	77969	9102W	4		
13		Handle, chrome plated brass	2404-101717	05704	807	2		
14		Knob, CURRENT LIMIT	2405-190249	89536	2405-190249	1		
15		Knob, DIGITS 1-7	2405-158949	89536	2405-158949	7		
16		Knob, METER, POWER, VOLTAGE RANGE	2405-158956	89536	2405-158956	3		
17		Knob, VOLTAGE TRIP						
17a		Concentric	2405-162347	89536	2405-162347	1		
17b		vernier	2405-241018	89536	2405-241018	1		
17c		trim disc	2405-236950	89536	2405-236950	1		
18		Lens, decimal, clear	3155-222596	89536	3155-222596	3		
19		Lens, decimal, red	3155-228056	89536	3155-228056	2		
20		Link, shorting, copper	2811-190728	24655	938LG	2		
21		Panel, front	1406-228775	89536	1406-228775	1		
22		Shaft, S3 (not illustrated)	3103-227272	89536	3103-227272	1		
23		Shaft, S3 to front panel	3103-240879	89536	3103-240879	1		
24		Shaft, S1	3103-239392	89536	3103-239392	1		
25		Shaft, Digit Switches, S1, S4, R6	3103-226928	89536	3103-226928	10		

REF DESIG	INDEX NO	DESCRIPTION	STOCK NO	MFR	MFR PART NO	TOT QTY	REC QTY	USE CODE
A1		<b>CAPACITOR P/C ASSEMBLY</b> Figure 5-2	1702-239343 (332B-4005)	89536	1702-239343	REF		
C1	E3-L3	Cap, plstc, 1 uf ± 20%, 250v	1507-190330	73445	C280AE/P1M	8		
C2	E1-I2	Cap, plstc, 1 uf ± 20%, 250v	1507-190330	73445	C280AE/P1M	REF		
CR1	E1-J4	Diode, silicon, 1 amp, 100 piv	4802-116111	05277	1N4817	REF		
CR2	E2-I4	Diode, silicon, 1 amp, 100 piv	4802-116111	05277	1N4817	REF		

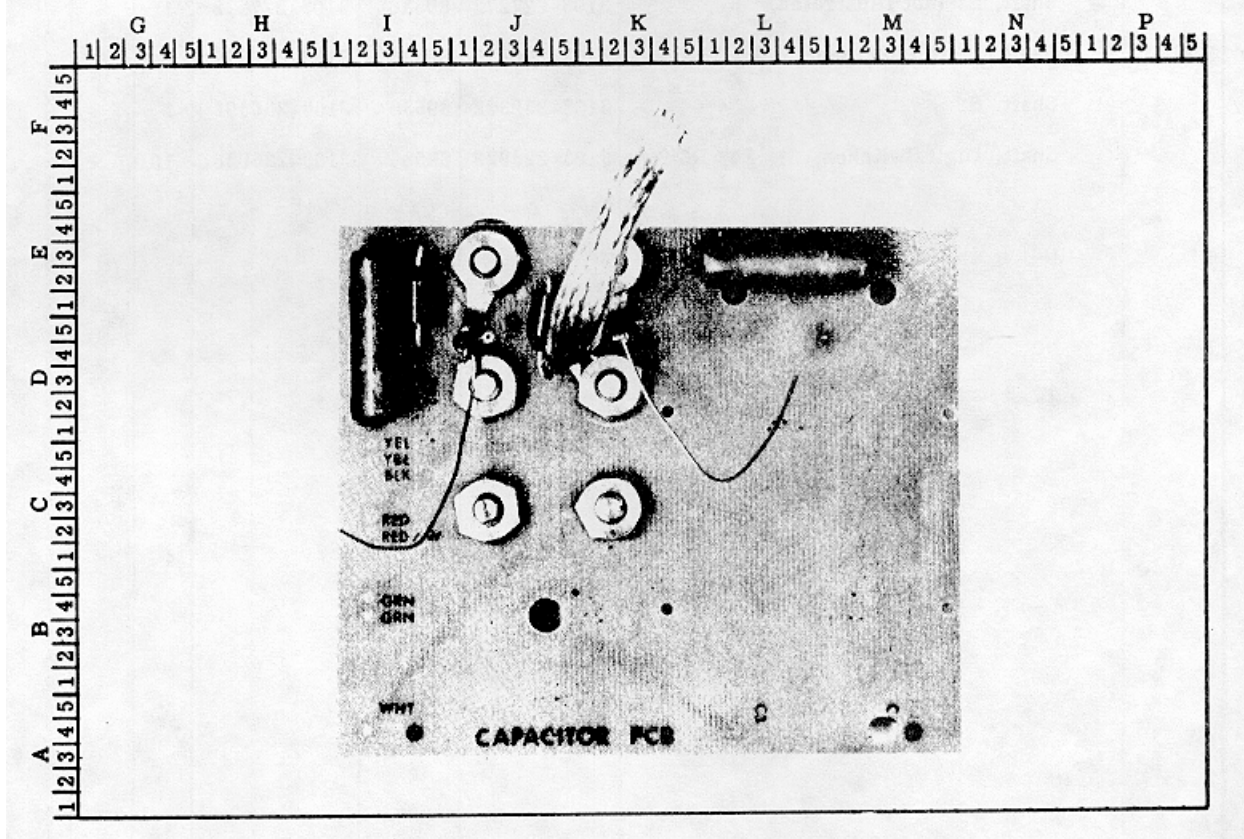











Figure 5-2. CAPACITOR P/C ASSEMBLY

REF DESIG	DESCRIPTION	STOCK NO	MFR	MFR PART NO	TOT QTY	REC QTY	USE CODE
A2	<b>SAMPLE STRING P/C ASSEMBLY</b> <b>Figure 5-3</b>	314849	89536	314849	REF		
R1, R2	Res, met flm, $34\Omega \pm 1\%$ , 1/8w	296699	91637	TYPE MFF1/8	2		
R3, R4	Res, met flm, $20\Omega \pm 1\%$ , 1/8w	236844	91637	TYPE MFF1/8	2		
R5, R6	Res, var, cer met $50\Omega \pm 20\%$ , 1/2w	267815	71450	190PC500B	2		
R7, R8, R9, R10, R1, R12	Res, var, cer met $20\Omega \pm 20\%$ , 1/2w	261180	71450	190PC200B	6		
R13 thru R24	Res, met flm, $10\Omega \pm 1\%$ , 1/8w	268789	91637	TYPE MFF1/8	12		
R25	Res, $997.5\Omega$ , matched set		89536		1		
R26	Res, $1996.5\Omega$ , matched set				1		
R27, R28	Res, $3.995k$ , matched set		89536		2		
R29 thru R35	Res, $19.985k$ , matched set		89536		7		
R36 thru R46	Res, $99.925k$ , matched set		89536		11		
R47	Res, var, cer met, $100\Omega \pm 20\%$ , 1/2w	267823	71450	190PC101B	1		
R48	Res, var, cer met, $200\Omega \pm 20\%$ , 1/2w	284711	71450	190PC201B	1		
R49, R50	Res, var, cer met, $500\Omega \pm 20\%$ , 1/2w	267849	71450	190PC501B	2		
R51	Res, met flm, $100\Omega \pm 1\%$ , 1/8w	168195	91637	TYPE MFF1/8	1		
R52	Res, met flm, $200\Omega \pm 1\%$ , 1/8w	245340	91637	TYPE MFF1/8	1		
R53, R54	Res, met flm, $348\Omega \pm 1\%$ , 1/8w	236778	91637	TYPE MFF1/8	2		
R55	Res, ww, $2\Omega \pm 0.2\%$ , 1/10w	131870	89536	131870	1		
R56	Res, ww, $1\Omega \pm 2\%$ , 1/10w	131888	89536	131888	1		
R57, R58	Res, ww, $4\Omega \pm .015\%$ , 1/4w	313809	89536	313809	2		
R59	Res, ww, $10\Omega \pm 9\%$ , 1/2w	155879	89536	155879	1		
R60	Res, ww, $20\Omega \pm 5\%$ , 1/2w	155887	89536	155887	1		
R61, R62	Res, ww, $40\Omega$ , 1/2w	158022	89536	158022	2		
R63	Res, ww, $100\Omega \pm 0.15\%$ , 1/2w	155846	89536	155846	1		
R64	Res, ww, $200\Omega \pm 0.15\%$ , 1w	131656	89536	131656	1		

REF DESIG	DESCRIPTION	STOCK NO	MFR	MFR PART NO	TOT QTY	REC QTY	USE CODE
R65, R66	Res, ww, 400Ω ± 0.25%, 1/2w	131698	89536	131698	2		
S1 thru S6	Switch, rotary, sample string	313023	76854	249	6		
S7	Switch, assembly, seventh decade (R67 thru R76 included)	291021	89536	291021	1		



factory matched for resistance accuracy and temperature coefficient. When ordering, include all information stamped on the resistor (if not legible include information on adjacent resistors) in addition to the information requested in paragraph regarding obtaining parts.



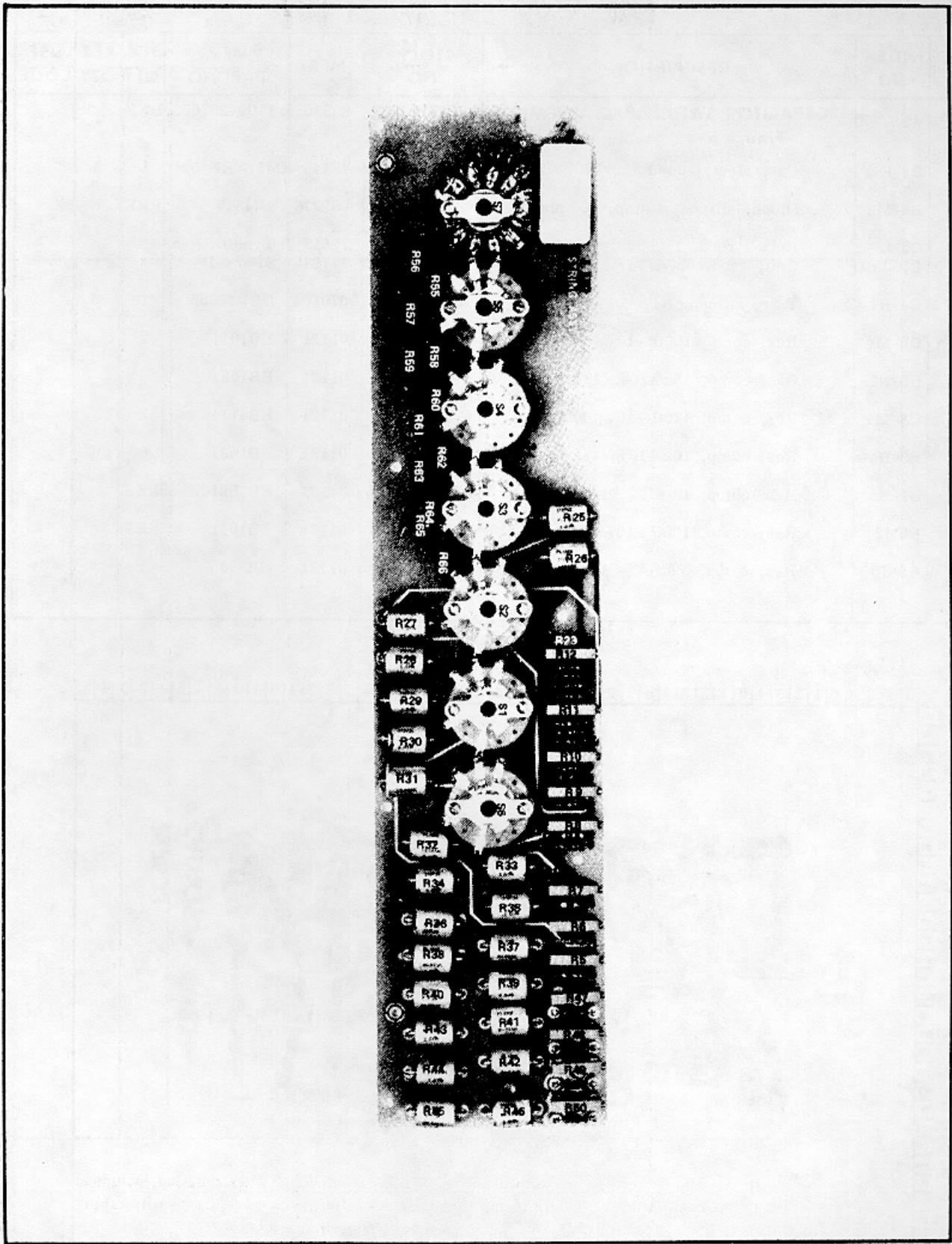

Figure 5-3. SAMPLE STRING P/C ASSEMBLY

REF DESIG	INDEX NO	DESCRIPTION	STOCK NO	MFR	MFR PART NO	TOT QTY	REC QTY	USE CODE
A3		<b>CAPACITOR SWITCH P/C ASSEMBLY</b> Figure 5-4	1702-22760 (335A-4092)	389536	1702-227603	REF		
C1	D5-K1	Cap, elect, 400 uf +50/-10%, 25v	1502-168153	73445	C437ARF400	1	1	
CR1	D4-M2	Diode, silicon, 1 amp, 100 piv	4802-116111	05277	IN4817	REF		
K1	C5-I5 C5-J5	Relay, reed, 1, 000v Coil, reed relay, 24v	5103-233916 1802-186155	12617 71707	Type DRR-5 SP-24-P	1 4		
Q1	D4-H4	Tstr, silicon, NPN	4805-203489	07910	CDQ10656	18	5	
R1	D5-M4	Res, comp, 100Ω ± 10%, 1/2w	4704-108100	01121	EB1011	2		
R2	D5-N2	Res, comp, 15k ± 10%, 1/2w	4704-108530	01121	EB1531	6		
R3	C3-M4	Res, comp, 470Ω ± 10%, 1/2w	4704-108415	01121	EB4711	2		
R4	E3-H4	Res, comp, 10k ± 10%, 1/2w	4704-108118	01121	EB1031	8		
R5	D1-H5	Res, comp, 1k ± 10%, 1/2w	4704-108563	01121	EB1021	REF		
R6	B5-I2	Res, comp, 100Ω ± 10%, 1/2w	4704-108100	01121	EB1011	REF		
R7	B5-J5	Res, comp, 39k ± 5%, 1w	4704-236729	01121	GB3935	1		

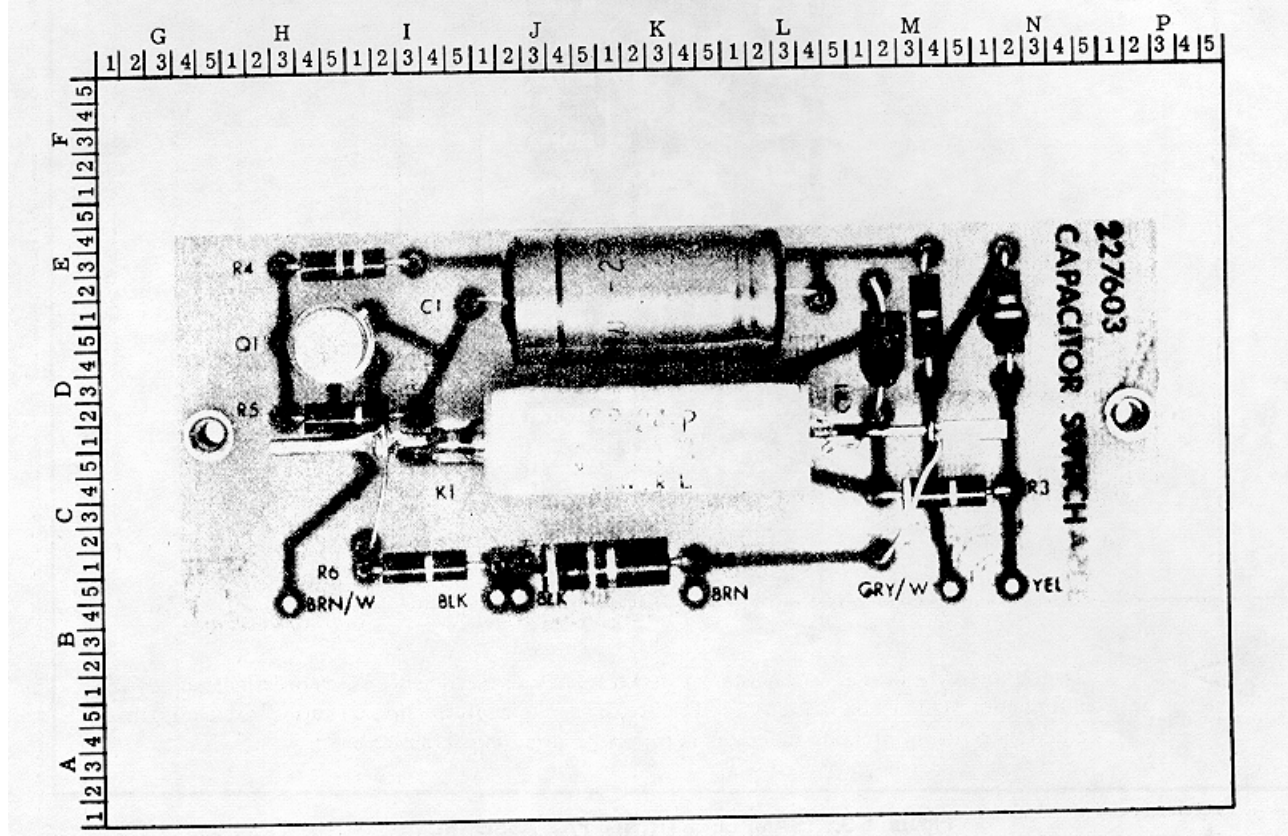







Figure 5-4. CAPACITOR SWITCH P/C ASSEMBLY

REF DESIG	DESCRIPTION	STOCK NO	MFR	MFR PART NO	TOT QTY	REC QTY	USE CODE
A4	<b>RANGE CALIBRATION P/C ASSEMBLY Figure 5-5</b>	314856	89536	314856	REF		
R1	Res, var, cer met, $20\Omega \pm 20\%$ , 1/2w	261180	71450	190PC200B	1		
R2, R3	Res, ww, 7.492k, matched set		89536		2		
R4	Res, met flm, $20\Omega \pm 1\%$ , 1/2w	296350	91637	TYPEMFF1/8	1		
R5	Res, var, cer met $200\Omega \pm 20\%$ , 1/2w	284711	71450	190PC201B	1		
R6, R7	Res, ww, 74.925k, matched set		89536		2		
R8	Res, met flm, $200\Omega \pm 196\%$ , 1/2w	151480	91637	TYPE MFF1/8	1		
R9	Res, var, cer met, $2k \pm 20\%$ , 1/2w	267864	71450	190PC202B	1		
R10, R11	Res, ww, 749.25k, matched set		89536		2		
R12	Res, met flm, $2k \pm 1\%$ , 1/2w	151266	91637	TYPE MFF1/2	1		
T1	Test point, red	170480	74970	105-752	1		
T2	Test point, black	149112	74970	105-0753	1		



Factory matched for resistance accuracy and temperature coefficient. When ordering, include all information stamped on the resistor (if not legible include information on adjacent resistors) in addition to the information requested in paragraph regarding obtaining parts.

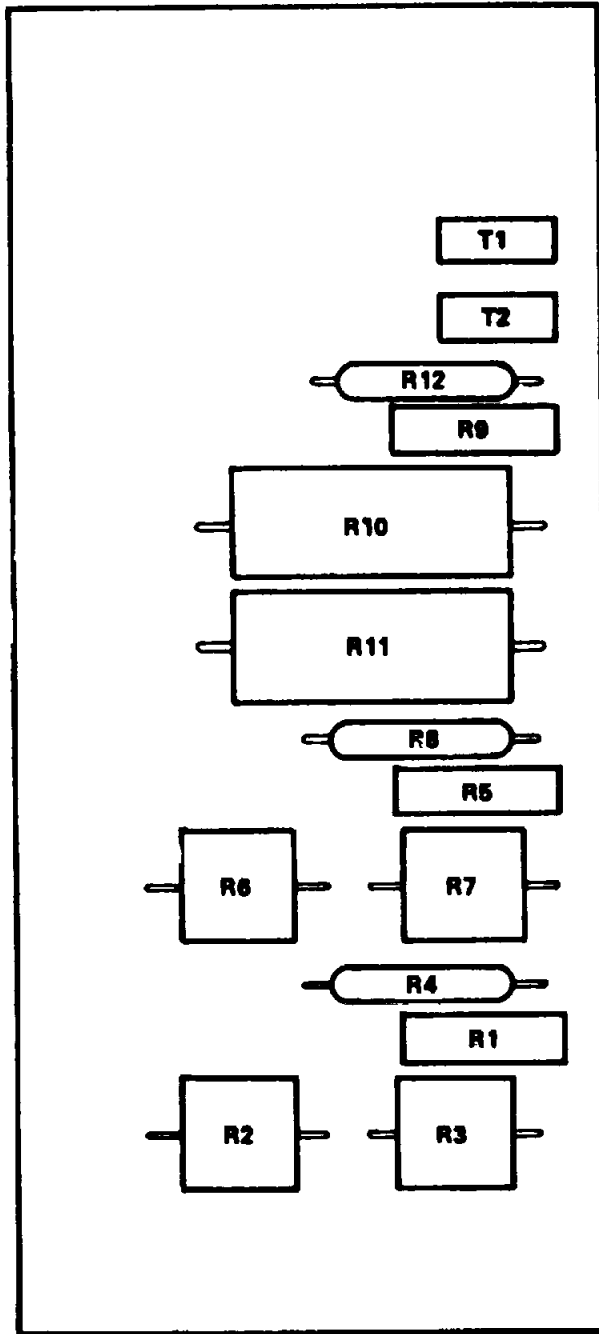

Figure 5-5. RANGE CALIBRATION P/C ASSEMBLY

REF DESIG	INDEX NO	DESCRIPTION	STOCK NO	MFR	MFR PART NO	TOT QTY	REC QTY	USE CODE
A5		<b>MAIN MOTHER BOARD P/C ASSEMBLY - Figure 5-6</b>	1702-219238 (335A-4064)	89536	1702-219238	REF		
A5A1		Reference Supply P/C Assembly (See Figure 5-7)	1702-314864 (332B/AF- 4083)	89536	1702-314864	REF		
A5A2		Series Pass Driver P/C Assembly (See Figure 5-8)	1702-219154 (335A-4056)	89536	1702-219154	REF		
A5A3		Differential Amplifier P/C Assembly (See Figure 5-9)	1702-219162 (335A-4057)	89536	1702-219162	REF		
A5A4		Chopper Amplifier P/C Assembly (See Figure 5-10)	1702-314872 (332B/AF- 4004)	89536	1702-314872	REF		
A5A5		Auxiliary Power Supply P/C Assembly (See Figure 5-11)	1702-219188 (335A-4059)	89536	1702-219188	REF		
A5A6		Current Limiter P/C Assembly (See Figure 5-12)	1702-219196 (335A-4060)	89536	1702-219196	REF		
C1	J4-T4	Cap, plstc, 0.1 uf $\pm$ 20%, 200v	1507-106435	56289	192P10402	4		
DS1	B3-Q2	Lamp, neon	3902-185017	74276	NE-7	2	5	
DS2	B4-P3	Lamp, neon	3902-185017	74276	NE-7	REF		
R1	B2-T3	Res, met flm, 23.7k $\pm$ 1%, 1/2w	4705-169383	75042	Type CEC-TO	2		
R2	B2-T1	Res, met flm, 25.5k $\pm$ 1%, 1/2w	4705-219006	75042	Type CEC-TO	1		
R3	B2-S4	Res, met flm, 267k $\pm$ 1%, 1/2w	4705-218990	75042	Type CEC-TO	1		
R4	B2-S3	Res, met flm, 274k $\pm$ 1%, 1/2w	4705-218982	75042	Type CEC-TO	1		
R5	A5-R2	Res, car flm, 1.82M $\pm$ 1%, 1/2w	4703-219089	75042	Type C12	3		
R6	B1-R2	Res, car flm, 1.82M $\pm$ 1%, 1/2w	4703-219089	75042	Type C12	REF		
R7	B2-R2	Res, car flm, 1.82M $\pm$ 1%, 1/2w	4703-219089	75042	Type C12	REF		
R8	C1-R3	Res, comp, 1k $\pm$ 10%, 1w	4704-109371	01121	GB1021	1		
R9	A5-P2	Res, comp, 470 $\Omega$ $\pm$ 10%, 1w	4704-109710	01121	GB4711	1		
XA5A1	K3-P5	Connector, female, 16 contact	2107-187732	91662	00-5009-016- 153-001	8		
XA5A2	I5-Q1	Connector, female, 16 contact	2107-187732	91662	00-5009-016- 153-001	REF		
XA5A3	H2-Q2	Connector, female, 16 contact	2107-187732	91662	00-5009-016- 153-001	REF		
XA5A4	F4-Q3	Connector, female, 16 contact	2107-187732	91662	00-5009-016- 153-001	REF		
XA5A5	D5-Q3	Connector, female, 16 contact	2107-187732	91662	00-5009-016- 153-001	REF		
XA5A6	C2-Q4	Connector, female, 16 contact	2107-187732	91662	00-5009-016- 153-001	REF		

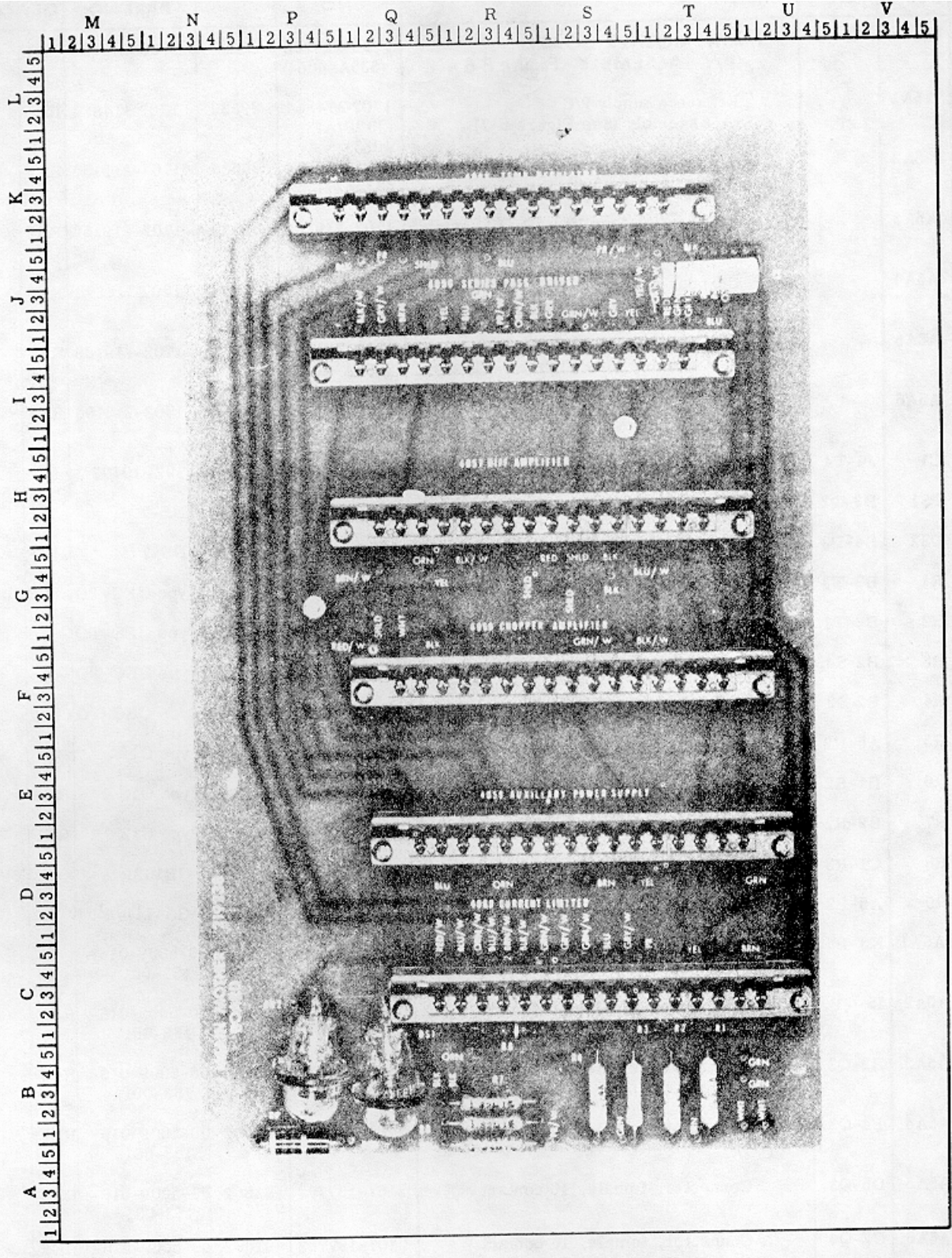

Figure 5-6. MAIN MOTHER BOARD P/C ASSEMBLY

REF DESIG	DESCRIPTION	STOCK NO	MFR	MFR PART NO	TOT QTY	REC QTY	USE CODE
A5A1	REFERENCE SUPPLY P/C ASSEMBLY Figure 5-7	314864	89536	314864	REF		
A1	IC, voltage neg	313106	MOTO- ROLA	MC1723CG	1		
A2	IC, Operational amplifier	271502	12040	LM301A	1		
A3	Ref amp oven	248914	01295	4STI-2	1		
C1	Cap, mica, 510 pf $\pm 5\%$ , 500V	148411	14655	CD19FSII5J	1		
C2	Cap, mica, 27 pf $\pm 5\%$ , 500V	177998	14655	CD15F221J	1		
C3	Cap, plstc, 0.1 uf $\pm 10\%$ , 500V	271866	06001	75F2RSA104	1		
Q1	Tstr, Semicon	203489	07910	CDQ10656	1		
R1, R3, R5	Res, met flm, 6.04k $\pm 1\%$ , 1/2w	162586	91637	TYPE MFF1/2	3		
R2, R4, R6	Res, var, cer met, 10k $\pm 20\%$ , 1/2w	267880	71450	190PC103B	3		
R7A, R7B, R13	Res, ref amp, matched set (R7A is always 9k res)	314971	89536	314971	1		
R8, R10	Res, ww, 50 $\Omega$ $\pm 0.06\%$ , 1/2w	238493	89536	238493	2		
R9	Res, var, cer met 50 $\Omega$ $\pm 20\%$ , 1/2w	267815	71450	190PC500B	1		
RK11	Not used						
R12	Res, met flm, 2.94k 1%, 1/2w	247528	91637	TYPEMFF1/2	1		
R14	Res, met flm, 6.34k $\pm 1\%$ , 1/2w	218636	91637	TYPE MFF1/2	1		
R15	Res, met flm, 8.66k $\pm 1\%$ , 1/2w	247957	91637	TYPE MFF1/2	1		
R16	Res, met flm, 16.9k $\pm 1\%$ , 1/2w	198275	91637	TYPEMFF1/2	1		
R17	Res, met flm, 7.5k $\pm 1\%$ , 1/2w	186072	91637	TYPE MFF1/2	1		
R18	Res, met flm, 4.99k $\pm 1\%$ , 1/2w	148890	74970	105-0753	1		
R19	Res, comp, 33 $\Omega$ 5%, 2w	161497	01121	HB3305	1		
R20	Res, comp, 1.5 $\Omega$ $\pm 5\%$ , 1/2w	246793	01121	EB15G5	1		

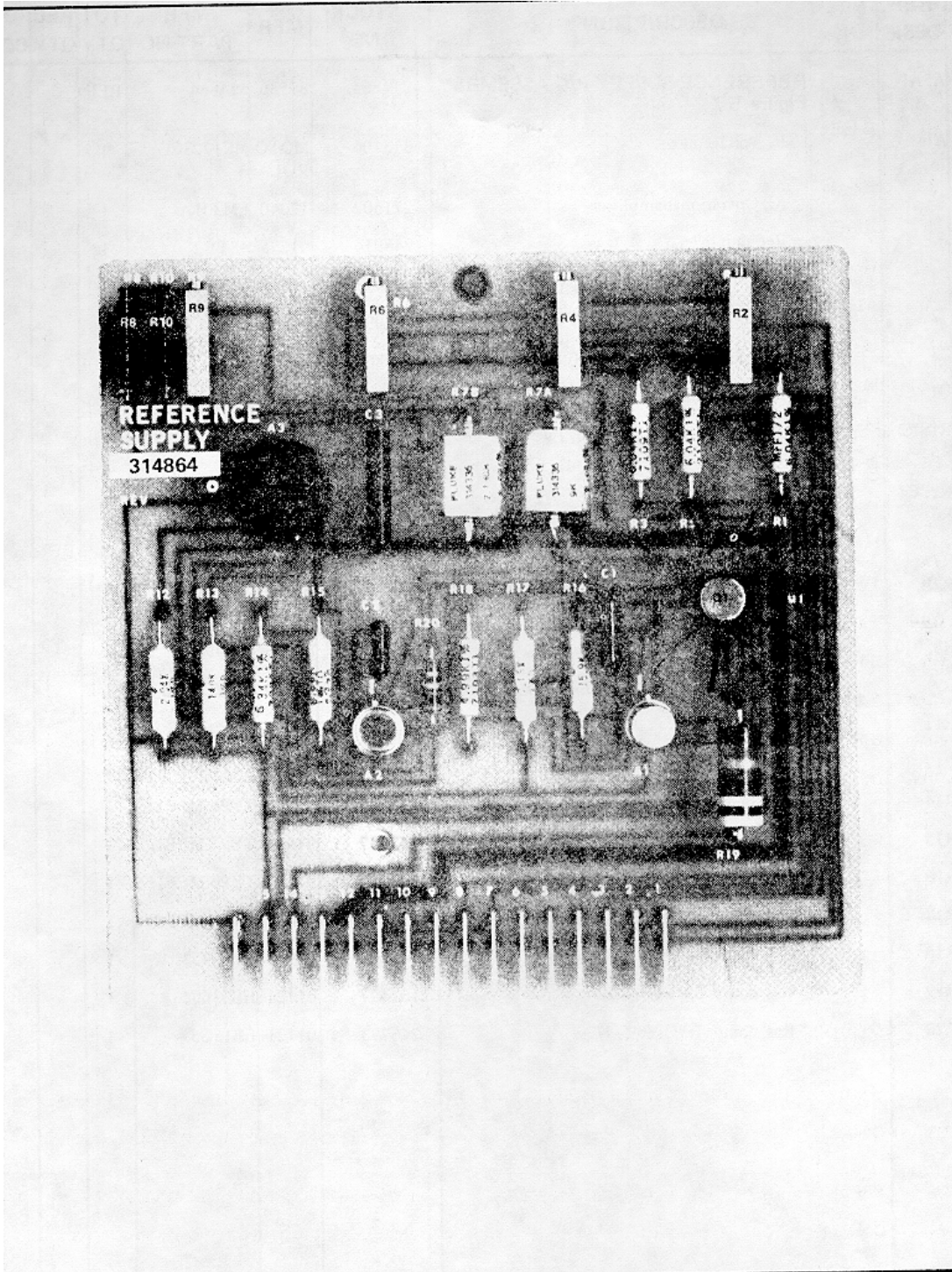

Figure 5-7. REFERENCE SUPPLY P/C ASSEMBLY



REF DESIG	INDEX NO	DESCRIPTION	STOCK NO	MFR	MFR PART NO	TOT QTY	REC QTY	USE CODE
A5A2		<b>SERIES PASS DRIVER P/C ASSEMBLY - Figure 5-8</b>	1702-219154	89536	1702-219154	REF		
C1	G4-P4	Cap, plstc, 0.47 uf ±20%, 250v	(335A-4056) 1507-184366	73445	C280AE/P470 K	1		
C2	F2-Q5	Cap, Ta, 2.2 uf ±10%, 20v	1508-160226	05397	K2R2C20K	1		
C3	E2-Q5	Cap, plstc, 0.1 uf ±20%, 200v	1507-106435	56289	192P10402	REF		
C4	G2-U5	Cap, plstic, . 22 uf ±10%, 80v	1507-159392	56289	192P2249RS	1		
C5	H1-Q1	Cap, Ta, 15 uf ±10%, 20v	1508-153056	05397	K15C20K	2		
CR1	I4-RI	Diode, silicon, 150 ma, 6 piv	4802-113308	07910	CD13161	5	1	C
CR1	I4-RI	Diode, silicon, 200 ma, 25 piv	4802-190272	93332	1N456A	2		D
CR1	14-RI	Diode, silicon, 1 amp, 100 piv	4802-116111	05277	1N4817	REF		E
CR2	14-81	Diode, silicon, 150 ma, 6 piv	4802-113308	07910	CD13161	REF		C
CR2	14-81	Diode, silicon, 200 ma, 25 piv	4802-190272	93332	1N456A	REF		D
CR2	14-S1	Diode, silicon, 1 amp, 100 piv	4802-116111	05277	1N4817	REF		E
CR3	F5-R3	Diode, zener, 10v	4803-113324	07910	1N961A	3	1	
CR4	E5-Q3	Diode, silicon, i amp, 100 piv	4802-116111	05277	1N4817	REF		
CR5	H3-U3	Diode, zener, 10v	4803-113324	07910	1N961A	REF		
CR6	F4-T1	Diode, silicon, 1 amp, 100 piv	4802-116111	05277	1N4817	REF		
CR7	D5-U2	Diode, silicon, 1 amp, 100 plv	4802-116111	05277	1N4817	REF		
CR8	D3-T4	Diode, silicon, 1 amp, 100 piv	4802-116111	05277	IN4817	REF		
CR9	D1-T4	Diode, silicon, 1 amp, 100 piv	4802-116111	05277	1N4817	REF		
CR10	F2-T3	Diode, germanium, 75ma, 125piv	4802-150342	93332	1N277	1	1	L
CR10	F2-T3	Diode, silicon, 150 ma, 6 piv	4802-113308	07910	CD13161	4		M
CR11	F1-U2	Diode, silicon, 150 ma, 6 piv	4802-113308	07910	CD13161	REF		
CR12	E3-U4	Diode, silicon, 150 ma, 6 piv	4802-113308	07910	CD13161	REF		
CR13	E3-R2	Diode, silicon, 1 amp, 100 piv	4802-116111	05277	1N4817	REF		
CR14	H2-P2	Diode, zener, 4.3v	4803-180455	07910	1N749A	1	1	
CR15	J1-R3	Diode, silicon, 1 amp, 100 piv	4802-116111	05277	1N4817	REF		E
P1	C2-Q2	Connector, male, 16 contact :	4816-187724	91662	02-016-013- 5-200	REF		
Q1	F3-Q5	Tstr, tested, silicon, PNP	4805-159491	89536	11805-159491	11	2	
Q2	G5-R2	Tstr, silicon, NPN	4805-203489	07910	CDQ10656	REF		

REF DESIG	INDEX NO	DESCRIPTION	STOCK NO	MFR	MFR PART NO	TOT QTY	REC QTY	USE CODE
Q3	G4-N4	Tstr, silicon, NPN	4805-183004	95303	40250	REF		
Q4	H1-Q3	Tstr, tested, silicon, PNP	4805-159491	89536	4805-159491	REF		
Q5	E5-S4	Tstr, silicon, NPN	4805-203489	07910	CDQ10656	REF		
Q6	G5-U2	Tstr, tested, silicon, PNP	4805-159491	89536	4805-159491	REF		
Q7	E3-T4	Tstr, silicon, NPN	4805-203489	07910	CDQ10656	REF		
Q8	E1-Q1	Tstr, tested, silicon, PNP	4805-159491	89536	4805-159491	REF		
R1	E2-N3	Res, met flm, 4.02k $\pm$ 1%, 1/2w	4705-167478	75042	Type CEC-TO	2		
R2	J3-T3	Res, var, ww, 2k $\pm$ 10%, 1-1/4w	4702-198416	71450	Type 110	1		
R3	E3-N1	Res, comp, 2.7k $\pm$ 10%, 1w	4704-109496	01121	GB2721	1		
R4	E3-M5	Res, met flm, 4.02k $\pm$ 1%, 1/2w	4705-167478	75042	Type CEC-TO	REF		
R5	J3-P4	Res, var, ww, 3k $\pm$ 20%, 1-1/4w	4702-149781	71450	Type 110	2		
R6	15-S5	Res, met flm, 5.62k $\pm$ 1%, 1/2w	4705-219014	75042	Type CEC-TO	1		
R7	G2-R2	Res, comp, 100k $\pm$ 10%, 1/2w	4704-108126	01121	EB1041	3		
R9	G1-P2	Res, comp, 2.4k $\pm$ 5%, 1/2w	4704-108902	01121	EB2425	1		
R10	I1-P5	Res, comp, 47 $\pm$ 10%, 2w	4704-144352	01121	HB4701	2		
R11	E2-P2	Res, comp, 47 $\Omega$ $\pm$ 10%, 2w	4704-144352	01121	HB4701	REF		
R12	E3-N5	Res, comp, 36k $\pm$ 5%, 1/2w	4704-185991	01121	EB3635	4		
R13	I1-R5	Res, var, ww, 3k $\pm$ 20%, 1-1/4w	4702-149781	71450	Type 110	REF		
R14	D3-S1	Res, met flm, 1k $\pm$ 1%, 1/2w	4705-151324	75042	Type CEC-TO	1		
R15	E2-R4	Res, met flm, 221k $\pm$ 1%, 1/2w	4705-182527	75042	Type CEC-TO	3		
R16	G2-S4	Res, comp, 3.9k $\pm$ 10%, 1/2w	4704-161406	01121	EB3921	1		
R17	E1-S3	Res, comp, 20k $\pm$ 5%, 1/2w	4704-109041	01121	EB2035	3		
R18	G3-T3	Res, comp, 16k $\pm$ 5%, 1/2w	4704-159632	01121	EB1635	3		
R19	G5-S3	Res, comp, 10k $\pm$ 10%, 1/2w	4704-108118	01121	EB1031	REF		
R20	F5-T2	Res, comp, 27k $\pm$ 5%, 1/2w	4704-186023	01121	EB2735	1		
R21	F4-U2	Res, comp, 220 $\Omega$ $\pm$ 5%, 1/2w	4704-186031	01121	EB2215	1		
R22	E1-U2	Res, met flm, 10 $\Omega$ $\pm$ 1%, 1/2w	4705-151043	75042	Type CEC-TO	1		
R23	D2-S5	Res, comp, 47k $\pm$ 5%, 1/2w	4704-108738	01121	EB4735	2		
R24	H2-S2	Res, comp, 620 $\Omega$ $\pm$ 5%, 1/2w	4704-108704	01121	EB6215	2		
R25	H4-Q5	Res, comp, 47k $\pm$ 5%, 1/2w	4704-108738	01121	EB4735	REF		
R26	D3-P5	Res, comp, 180 $\Omega$ $\pm$ 10%, 2w	4704-155457	01121	HB1811	1		

REF DESIG	INDEX NO	DESCRIPTION	STOCK NO	MFR	MFR PART NO	TOT QTY	REC QTY	USE CODE
R27	D1-Q5	Res, comp, 2k ±5%, 1/2w	4704-169854	01121	EB2025	2		
R28	E5-P5	Res, comp, 8. 2k +5%, 1/2w	4704-147777	01121	EB8225	2		
	G1-N1	Heat sink	4806-186759	89536	4806-186759	REF		

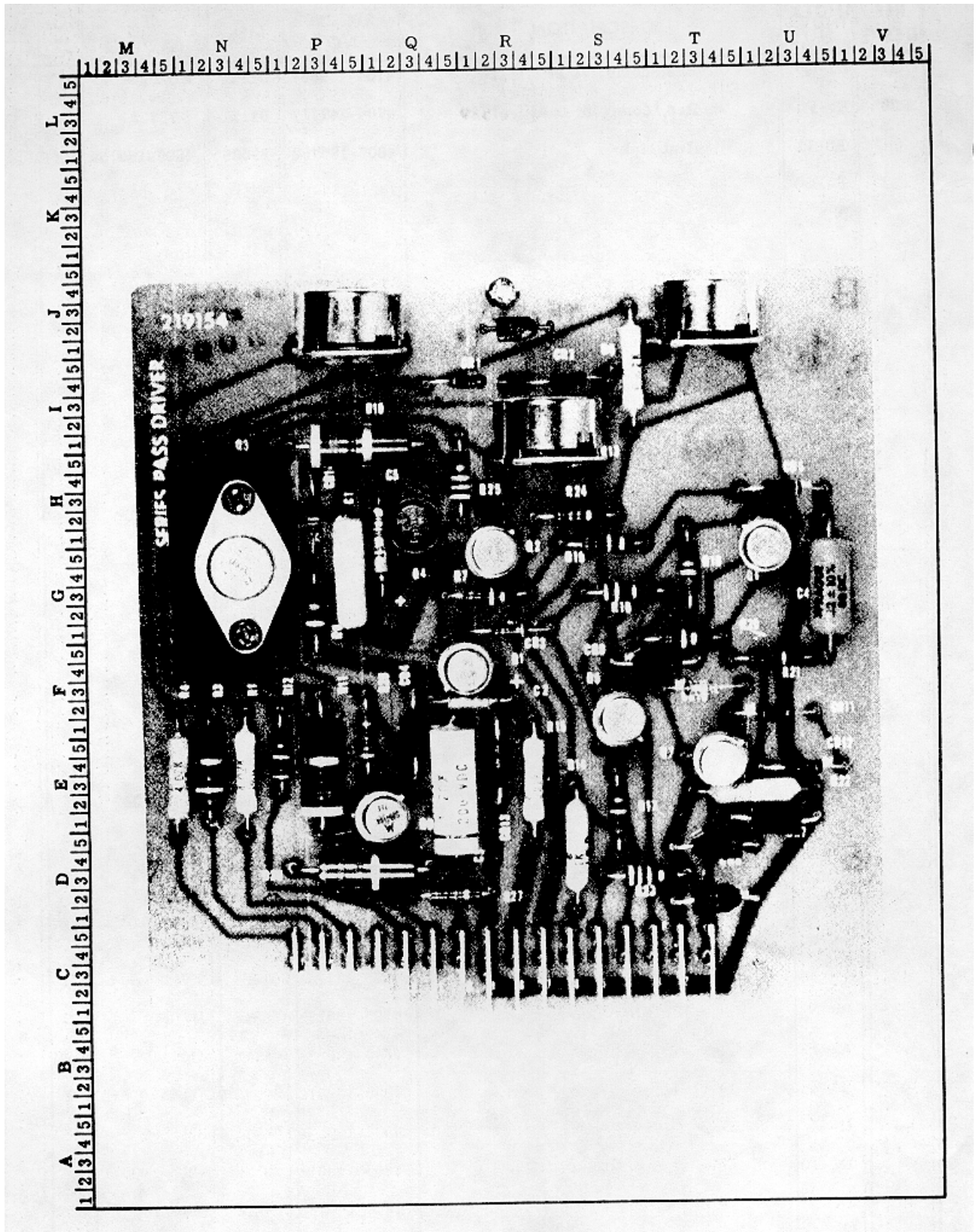

Figure 5-8. SERIES PASS DRIVER P/C ASSEMBLY

REF DESIG	INDEX NO	DESCRIPTION	STOCK NO	MFR	MFR PART NO	TOT QTY	REC QTY	USE CODE
A5A3		<b>DIFFERENTIAL AMPLIFIER P/C ASSEMBLY -Figure 5-9</b>	1702-219162 (335A-4057)	89536	1702-219162	REF		
C1	E3-P5	Cap, plstc, 0. 1 uf +10%, 50v	1507-150318	56289	194P1049R5	1		
C2	F4-Q5	Cap, mica, 510 pf ±5%, 500v	1504-148411	88419	CD19F511J	2		
C3	G1-P3	Cap, Ta, 15 uf +10%, 20v	1508-153056	05397	K15C20K	REF		
C4	14-R4	Cap, elect, 250 uf +50/-10%, 40v	1502-178616	73445	C437ARG250	1	1	
C5	I1-S3	Cap, mica, 27 pf ±5%, 500v	1504-177998	88419	CD15E270J	1		I
CR1	D4-R1	Diode, silicon, 1 amp, 100 piv	4802-116111	05277	1N4817	REF		
CR2	E5-S1	Diode, silicon, 1 amp, 100 piv	4802-116111	05277	1N4817	REF		
CR3	G1-S2	Diode, silicon, 1 amp, 100 plv	4802-116111	05277	1N4817	REF		
CR4	E4-R5	Diode, silicon, 1 amp, 100 piv	4802-116111	05277	1N4817	REF		
CR5	F5-R5	Diode, silicon, 1 amp, 100 piv	4802-116111	05277	1N4817	REF		
CR6	F3-R1	Diode, silicon, 1 amp, 100 piv	4802-116111	05277	1N4817	REF		
CR7	F1-R1	Diode, silicon, 1 amp, 100 piv	4802-116111	05277	IN4817	REF		
CR8	G2-R1	Diode, silicon, 1 amp, 100 piv	4802-116111	05277	iN4817	REF		
CR9	G1-R1	Diode, silicon, 1 amp, 100 piv	4802-116111	05277	iN4817	REF		
CR10	E5-S4	Diode, silicon, 1 amp, 100 piv	4802-116111	05277	1N4817	REF		
CR11	G1-S5	Diode, silicon, 1 amp, 100 piv	4802-116111	05277	IN4817	REF		
CR12	G1-T1	Diode, silicon, 1 amp, 100 piv	4802-116111	05277	1N4817	REF		
CR13	G1-Q2	Diode, silicon, 1 amp, 100 piv	4802-116111	05277	1N4817	REF		
CR14	G1-N5	Diode, zener, 10v	4803-113324	07910	1N961A	REF		
CR15	13-T2	Diode, silicon, 1 amp, 100 piv	4802-116111	05277	1N4817	REF		
P1	C3-Q2	Connector, male, 16 contact	2816-187724	91662	02-016-013- 5-200	REF		
Q1	D2-T1	Tstr, silicon, NPN	4805-177105	07263	2N3565	5		
Q2	D5-N2	Tstr, FET, silicon N-channel	4805-166223	15818	U-1249	2		
Q3	F2-N2	Tstr, silicon, PNP	4805-190389	04713	SM4144	REF		
Q4	H2-Q1	Tstr, tested, silicon, NPN	4805-198812	89536	4805-198812	2	1	
Q5	I1-Q2	Tstr, silicon, PNP	4805-190389	04713	SM4144	REF		
Q6	D2-T5	Tstr, tested, silicon, NPN	4805-198812	89536	4805-198812	REF		
Q7	D2-U3	Tstr, silicon, PNP	4805-190389	04713	SM4144	REF		
Q8	H3-R3	Tstr, silicon, NPN	4805-203489	07910	CDQ10656	REF		

REF DESIG	INDEX NO	DESCRIPTION	STOCK NO	MFR	MFR PART NO	TOT QTY	REC QTY	USE CODE
Q9	I2-T5	Tstr, silicon, PNP	4805-183558	04713	2N3250	3	1	
Q10	E4-U3	Tstr, silicon, PNP	4805-183558	04713	2N3250	REF		
Q11	I1-U4	Tstr, silicon, PNP	4805-183558	04713	2N3250	REF		
Q12	E1-U3	Tstr, silicon, NPN	4805-177105	07263	2N3565	REF		
R1	D3-S1	Res, comp, 22k $\pm$ 5%, 1/2w	4704-186064	01121	EB2235	3		
R2	D3-R3	Res, comp, 100 $\Omega$ $\pm$ 5 *5%, 1/2w	4704-188508	01121	EB1015	6		
R3	D3-R5	Res, comp, 100 $\Omega$ $\pm$ 5%, 1/2w	4704-188508	01121	EB1015	REF		
R4	D3-S3	Res, ww, 10k $\pm$ 0.2%, 1/4w	4707-112177	89536	4707-112177	1		
R5	E5-S3	Res, comp, 100 $\Omega$ $\pm$ 5%, 1/2w	4704-188508	01121	EB1015	REF		
R6	F5-S3	Res, comp, 100 $\Omega$ - $\pm$ 5%, 1/2w	4704-188508	01121	EB1015	REF		
R7	E4-T1	Res, comp, 1k $\pm$ 5%, 1/2w	4704-108597	01121	EB1025	10		
R8	D3-Q3	Res, comp, 3.3k $\pm$ 5%, 1/2w	4704-165761	01121	EB3325	4		
R9	D3-Q2	Res, comp, 3k $\pm$ 5%, 1/2w	4704-109090	01121	EB3025	2		
R10	D3-P5	Res, comp, 510 $\Omega$ $\pm$ 5%, 1/2w	4704-108951	01121	EB5115	1		
R11	EI-P1	Res, comp, 22M $\pm$ 10%, 1/2w	4704-108233	01121	EB2261	1		
R12	F1-M5	Res, comp, 6.2k $\pm$ 5%, 1/2w	4704-108621	01121	EB6225	3		
R13	G1-N3	Res, comp, 2.2k $\pm$ 5%, 1/2w	4704-108506	01121	EB2225	2		
R14	G1-P1	Res, comp, 1.2k $\pm$ 10%, 1/2w	4704-108803	01121	EB1221	1		
R15	F5-P5	Res, met flm, 100k $\pm$ 1%, 1/2w	4705-151316	75042	Type CEC-TO	REF		
R16	I1-P1	Res, met flm, 221k $\pm$ 1%, 1/2w	4705-182527	75042	Type CEC-TO	REF		
R17	H4-P1	Res, met flm, 40.2k $\pm$ 1%, 1/2w	4705-161059	75042	Type CEC-TO	2		
R18	G4-R1	Res, met flm, 75 $\Omega$ $\pm$ 1%, 1/2w	4705-150870	75042	Type CEC-TO	2		
R19	E4-T4	Res, met flm, 75 $\Omega$ $\pm$ 1%, 1/2w	4705-150870	75042	Type CEC-TO	REF		
R20	E4-T5	Res, met flm, 221k $\pm$ 1%, 1/2w	4705-182527	75042	Type CEC-TO	REF		
R21	F4-U4	Res, met flm, 40. 2k $\pm$ 1%, 1/2w	4705-161059	75042	Type CEC-TO	REF		
R22	H4-S3	Res, met flm, 6.04k $\pm$ 1%, 1/2w	4705-162586	75042	Type CEC-TO	REF		
R23	H1-S5	Res, met flm, 42.2k $\pm$ 1%, 1/2w	4705-182501	75042	Type CEC-TO	1		
R24	H2-S5	Res, met flm, 9. 09k $\pm$ 1%, 1/2w	4705-151258	75042	Type CEC-TO	1		
R25	I5-T5	Res, met flm, 15k $\pm$ 1%, 1/2w	4705-151498	75042	Type CEC-TO	1		
R26	F4-U3	Res, met flm, 1.58k $\pm$ 1%, 1/2w	4705-182543	75042	Type CEC-TO	2		
R27	G5-T4	Res, met flm, 1.58k $\pm$ 1%, 1/2w	4705-182543	75042	Type CEC-TO	REF		

REF DESIG	INDEX NO	DESCRIPTION	STOCK NO	MFR	MFR PART NO	TOT QTY	REC QTY	USE CODE
R28	G5-U1	Res, met flm, 9. 76k $\pm$ 1%, 1/2w	4705-182485	75042	Type CEC-TO	3		
R29	H3-V1	Res, comp, 10k $\pm$ 5%, 1/2w	4704-109165	01121	EB1035	2		
R30	H2-U4	Res, comp, 1k $\pm$ 5%, 1/2w	4704-108507	01121	EB1025	REF		
RS1	E3-T2	Res, comp, 2k $\pm$ 5%, 1/2w	4704-169854	01121	EB2025	REF		

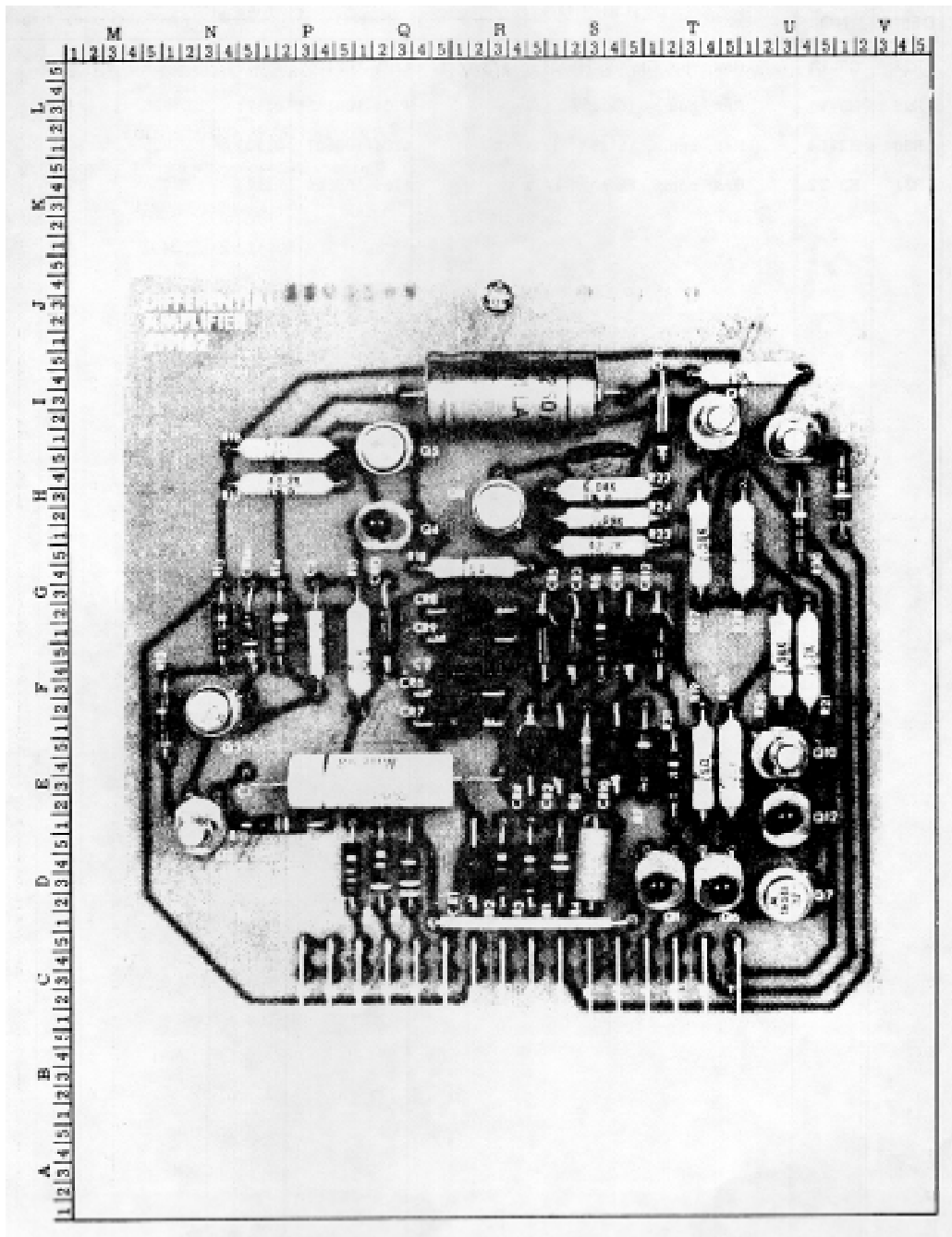

Figure 5-9. DIFFERENTIAL AMPLIFIER P/C ASSEMBLY



REF DESIG	DESCRIPTION	STOCK NO	MFR	MFR PART NO	TOT QTY	REC QTY	USE CODE
A5A4	<b>CHOPPER AMPLIFIER ASSEMBLY</b> <b>Figure 5-10</b>	314872	89536	314872	REF		
C1	Cap, plstc, 0.1 uf±10%, 250V	161992	73445	C280AE/A10C	1		
C2, C3	Cap, plstc, 0.0068 uf +20%, 200V	106070	56289	192P68202	2		
C4	Cap, plstc, 0.047 uf ± 10%, 250V	162008	73445	C280AE/A47K	1		
C5	Cap, mica, 4 pf ±5%, 500V	190397	14655	CD15C040K	1		
C6	Cap, mica, 640 pf±5%, 500V	215251	14655	CD19F6405	1		
C7, C13	Cap, elect, 5 uf +75/-100, 25V	152009	56289	30D505G025 BA4	2		
C8, C21	Cap, elect, 50 uf +50/-100%, 25V	168823	73445	C426ARF50	2		
C9, C23	Cap, elect, 100 uf +75/-10%, 3V	106534	56289	30D107G003 CB4	2		
C10	Cap, mica, 220 pf ±5%, 500V	170423	14655	CD15F221J	1		
C11	Cap, cer, 100 pf±10%, 1 kV	105593	71590	DD-101	1		
C12	Cap, mica, 5 pf ± 10%, 500V	148577	14655	CD15CO50K	1		
C14, C16	Cap, Ta, 33 uf±10%, 10V	182832	56289	150D336X90 10B2	2		
C15, C17	Cap, elect, 15 uf+75/--10%, 6V	105700	56289	30D156G006 BA4	2		
C18	Cap, Ta, 100 uf±10%, 10V	170456	05397	K100C10K	1		
C19, C20	Cap, plstc, 0.015 uf±2%, 100V	233577	02799	1PC-153-G	2		
C22	Cap, Ta, 0.47 uf±20%, 35V	161349	56289	196D474X00 35	1		
CR1	Diode, zener, silicon	150334	07910	CD36612	1		
CR2 thru CR9	Diode, silicon, 150 mA	203323	03508	DHD1105	8		
IC1	IC, operational amplifier	246603	07263	U5B770939X	1		
Q1	Tstr, MOS FET, P-channel	226043	07263	FT704	1		
Q2	Tstr, FET, N-channel	271924	07910	CFE13041	1		
Q3	Tstr, silicon, PNP	195974	04713	2N3906	1		
Q4	Tstr, silicon, PNP	288761	49956	RS2048	1		
Q5 thru Q7	Tstr, silicon, NPN	218396	04713	2N3904	3		

REF DESIG	DESCRIPTION	STOCK NO	MFR	MFR PART NO	TOT QTY	REC QTY	USE CODE
R1	Res, comp, 51k ± 5%, 1/4w	193334	01121	CB5135	1		
R2, R21 R22	Res, comp, 100k ± 5%, 1/4w	148189	01121	CB1045	3		
R3	Res, met flm, 604k ± 1%, 1/2w	182493	91637	TYPEMFF1/2	1		
R4	Res, comp, 10 ± 5%, 1/4w	147868	01121	CB1005	1		
R5	Res, met flm, 750k ± 1%, 1/2w	155192	91637	TYPE MFF1/2	1		
R6	Res, comp, 3.3M ± 5%, 1/4w	208389	01121	CB3355	1		
R7	Res, comp, 13k ± 5%, 1/4w	221598	01121	CB1335	1		
R8, R41 R42	Res, comp, 2002 ± 5%, 1/4w	193482	01121	CB2015	3		
R9, R32, R37, R39 R40	Res, comp, 22k ± 5%, 1/4w	148130	01121	CB2235 5			
R10, R12	Res, met flm, 34k ± 1%, 1/2w	151241	91637	TYPE MFF1/2	2		
R11	Res, comp, 10M ± 5%, 1/4w	194944	01121	CB1065	1		
R13	Res, comp, 1.5k ± 5%, 1/4w	148031	01121	CB1525	1		
R14	Res, met flm, 150Ω ± 1%, 1/2w	182550	91637	TYPE MFF1/2	1		
R15	Res, met flm, 8.06k ± 1%, 1/2w	159467	91637	TYPE MFF1/2	1		
R16	Res, met flm, 68.1k ± 1%, 1/2w	161083	91637	TYPE MFF1/2	1		
R17	Res, comp, 68k ± 5%, 1/4w	148171	01121	CB6835	1		
R18	Res, comp, 24k ± 5%, 1/4w	193425	01121	CB2435	1		
R19, R20	Res, met flm, 10k ± 1%, 1/2w	151274	91637	TYPE MFF1/2	2		
R23	Res, comp, 33k ± 5%, 1/4w	148155	01121	CB3335	1		
R24	Res, comp, 10k ± 5%, 1/4w	148106	01121	CB1035	1		
R25	Res, comp, 36k ± 5%, 1/4w	221929	01121	CB3635	1		
R26	Res, comp, 18k ± 5%, 1/4w	148122	01121	CB1835	1		
R27	Res, comp, 560Ω ± 5%, 1/4w	147991	01121	CB5615	1		
R28	Res, comp, 47k ± 5%, 1/4w	148163	01121	CB4735	1		
R29	Res, comp, 180k ± 5%, 1/4w	193441	01121	CB1845	1		
R30	Res, comp, 8.2k ± 5%, 1/4w	160796	01121	CB8225	1		
R31	Res, comp, 15k ± 5%, 1/4w	148114	01121	CB1535	1		
R33	Res, met flm, 4.22k ± 1%, 1/2w	223396	91637	TYPE MFF1/2	1		

REF DESIG	DESCRIPTION	STOCK NO	MFR	MFR PART NO	TOT QTY	REC QTY	USE CODE
R34	Res, var cer met, 5k $\pm$ 20%, 3/4w	159905	73138	78PR5K	1		
R35	Res, met flm, 24.3k $\pm$ 1%, 1/2w	217430	91367	TYPE MFF1/2	1		
R36, R38	Res, met flm, 187k $\pm$ 1%, 1/8w	289462	91637	TYPE MFF1/2	2		
R43	Res, var, comp, 10k $\pm$ 30%, 1/4w	233131	37942	TYPE MTC	1		
	Connector, male, 16 contact	187724	91662	02-106-013-5- 200	1		
	Cover, chopper	251751	89536	251751	1		

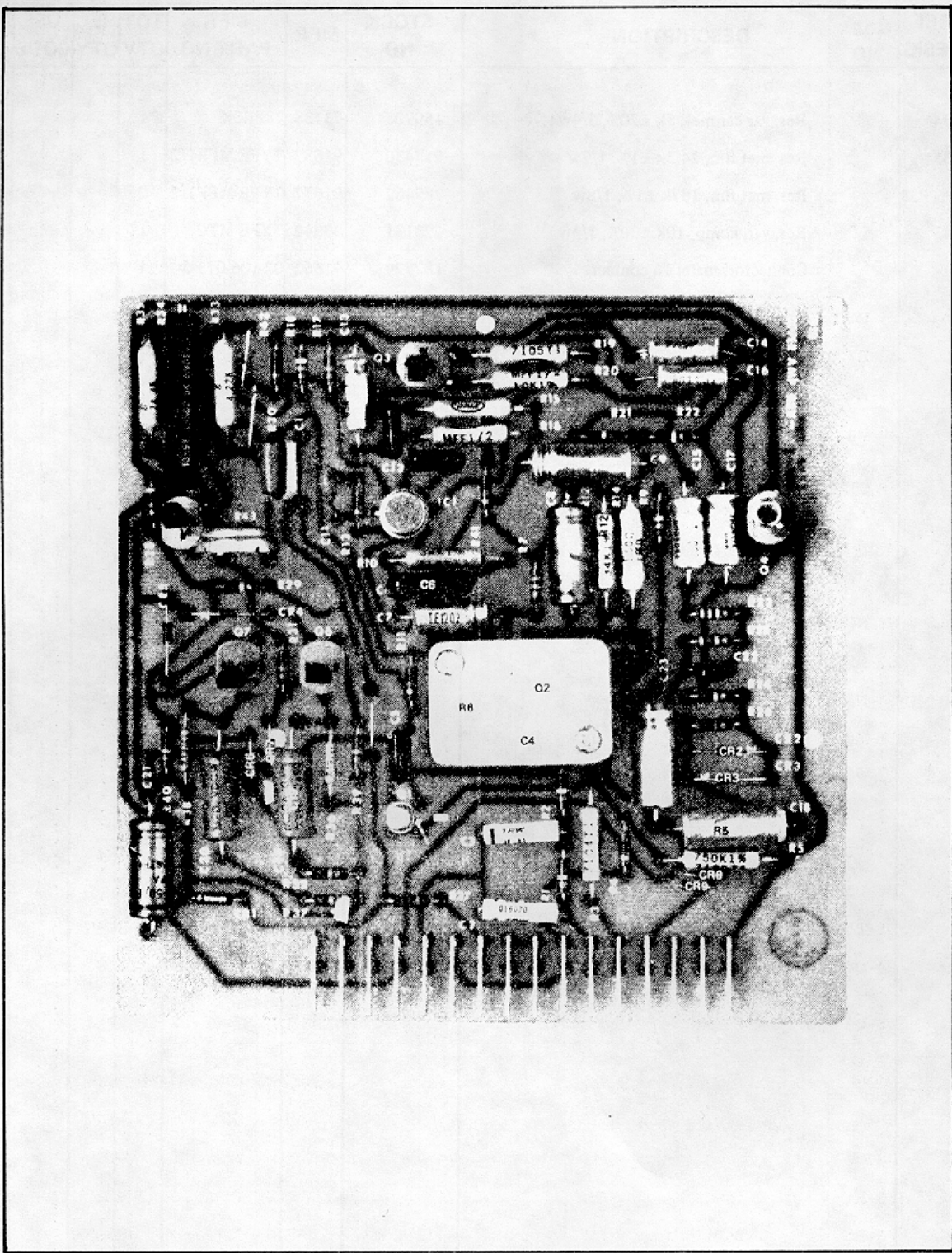

Figure 5-10. CHOPPER AMPLIFIER ASSEMBLY

REF DESIG	INDEX NO	DESCRIPTION	STOCK NO	MFR	MFR PART NO	TOT QTY	REC QTY	USE CODE
A5A5		<b>AUXILIARY POWER SUPPLY P/C ASSEMBLY - Figure 5-11</b>	1702-219188 (335A-4059)	89536	1702-219188	REF		
C1	G1-P5	Cap, Ta, 68 uf ± 10%, 15v	1508-182824	05397	K68C15K	1		
C2	GI-N3	Cap, elect, 250 uf ± 50/-10%, 64v	1502-185850	73445	C437ARH250	4	1	
C3	G1-P2	Cap, elect, 50 uf ± 75/-10%, 50v	1502-105122	80183	TE1307	3	1	
C4	J1-P3	Cap, cer, 220 pf ± 10%, 500v	1501-105528	72982	315-024X5UD- 221K	1		
C5	H1-R3	Cap, plstc, 2 uf ± 20%, 100v	1507-106963	84411	Type X663FR	2		
C6	E2-R3	Cap, plstc, 0.1 uf ± 20%, 200v	1507-106435	56289	192P10402	REF		
C7	H5-R2	Cap, elect, 20 uf ± 75/-10%, 50v	1502-106229	80183	TE1305	REF		
C8	E3-U3	Cap, elect, 50 uf ± 75/-10%, 50v	1502-105122	80183	TE1307	REF		
C9	H1-T1	Cap, plstc, 0.0012 uf ± 10%, 200v	1507-106088	56289	192P12292	1		
C10	E2-T1	Cap, plstc, 2 uf ± 20%, 100v	1507-106963	84411	Type X663FR	REF		
C11	I1-U5	Cap, elect, 20 uf ± 75/-10%, 50v	1502-106229	80183	TE1305	REF		
CR1	E2-N5	Diode, silicon, 1 amp, 100 piv	4802-116111	05277	1N4817	REF		
CR2	D3-N5	Diode, silicon, 1 amp, 100 piv	4802-116111	05277	1N4817	REF		
CR3	E4-N5	Diode, silicon, 1 amp, 100 piv	4802-116111	05277	1N4817	REF		
CR4	D5-N5	Diode, silicon, 1 amp, 100 piv	4802-116111	05277	1N4817	REF		
CR5	J1-M5	Diode, zener, 3.9v	4803-113316	07910	1N748	2	1	
CR6	E1-R5	Diode, zener, 6. 3v	4803-172148	03877	1N3496	1	1	
CR7	F1-U5	Diode, silicon, 1 amp, 100 piv	4802-116111	05277	1N4817	REF		
CR8	F1-T5	Diode, silicon, 1 amp, 100 piv	4802-116111	05277	1N4817	REF		
CR9	D5-U5	Diode, silicon, 1 amp, 100 piv	4802-116111	05277	1N4817	REF		
CR10	D5-T5	Diode, silicon, 1 amp, 100 piv	4802-116111	05277	1N4817	REF		
P1	C4-Q4	Connector, male, 16 contact	2816-187724	91662	02-016-013- 5-200	REF		
Q1	D5-Q3	Silicon controlled rectifier, 1.6 amp, 50v	4805-192567	03508	C-6F	2	1	
Q2	I4-N4	Tstr, selected, silicon, PNP	4805-159491	89536	4805-159491	REF		
Q3	I5-Q1	Tstr, silicon, NPN	4805-203489	07910	CDQ10656	REF		
Q4	I5-R5	Tstr, silicon, NPN	4805-183004	95303	40250	REF		
Q5	F3-R1	Tstr, silicon, NPN	4805-203489	07910	CDQ10656	REF		
Q6	F3-R5	Tstr, silicon, NPN	4805-203489	07910	CDQ10656	REF		

REF DESIG	INDEX NO	DESCRIPTION	STOCK NO	MFR	MFR PART NO	TOT QTY	REC QTY	USE CODE
Q7	G4-U2	Tstr, silicon, NPN	4805-183004	95303	40250	REF		
Q8	I4 -T2	Tstr, silicon, NPN	4805-203489	07910	CDQ10656	REF		
Q9	G1-T2	Tstr, silicon, NPN	4805-203489	07910	CDQ10656	REF		
R1	E5-P5	Res, comp, 10k $\pm$ 5%, 1/2w	4704-109165	01121	EB1035	REF		
R2	E5-Q3	Res, comp, 390w $\pm$ 5%, 1/2w	4704-109082	01121	EB3915	1		
R3	E5-Q2	Res, comp, 5. Sk $\pm$ 5%, 1/2w	4704-187880	01121	EB5625	1		
R4	H3-N3	Res, comp, 15 $\Omega$ $\pm$ , 10%, 2w	4704-155549	01121	HB1501	1		
R5	I1-N5	Res, comp, 15k $\pm$ 10%, 1/2w	4704-108530	01121	EB1531	REF		
R6	J1-P1	Res, comp, 3k $\pm$ 5%, 1/2w	4704-109090	01121	EB3025	REF		
R7	14-Q4	Res, comp, 33k $\pm$ 10%, 1/2w	4704-178541	01121	EB3331	REF		
R8	G4-R3	Res, met flm, 7.15k $\pm$ 1%, 1/2w	4705-186072	75042	Type CEC-TO	1		
R9	J4-T2	Res, var, ww, 1k $\pm$ 20%, 1-1/4w	4702-113266	71450	Type 110	1		
R10	E2-R1	Res, met flm, 2.55k $\pm$ 1%, 1/2w	4705-176362	75042	Type CEC-TO	1		
R11	G3-S2	Res, comp, 6. 2k $\pm$ 5%, 1/2w	4704-108621	01121	EB6225	REF		
R12	E2-S1	Res, met flm, 2.37k $\pm$ 1%, 1/2w	4705-182519	75042	Type CEC-TO	1		
R13	G1-S2	Res, comp, 12k $\pm$ 10%, 1/2w	4705-108977	01121	EB1231	1		
R14	G2-V1	Res, comp, 82 $\Omega$ $\pm$ 10%, 2w	4704-110239	01121	HB8201	1		
R15	H4-S4	Res, comp, 8. 2k $\pm$ 5%, 1/2w	4704-147777	01121	EB8225	REF		
R16	H4-T4	Res, comp, 3.3k $\pm$ 10%, 1/2w	4704-108373	01121	EB3321	1		
R17	H2-T2	Res, comp, 4.7k $\pm$ 10%, 1/2w	4704-108381	01121	EB4721	2		
R18	E4-S4	Res, met flm, 8.45k $\pm$ 1%, 1/2w	4705-159475	75042	Type CEC-TO	1		
R19	E4-T3	Res, met flm, 4.99k $\pm$ 1%, 1/2w	4705-148890	75042	Type CEC-TO	1		
R20	I5-P3	Res, comp, 2. 0k $\pm$ 5%, 1/2w	4704-169854	01121	EB2025	REF		P

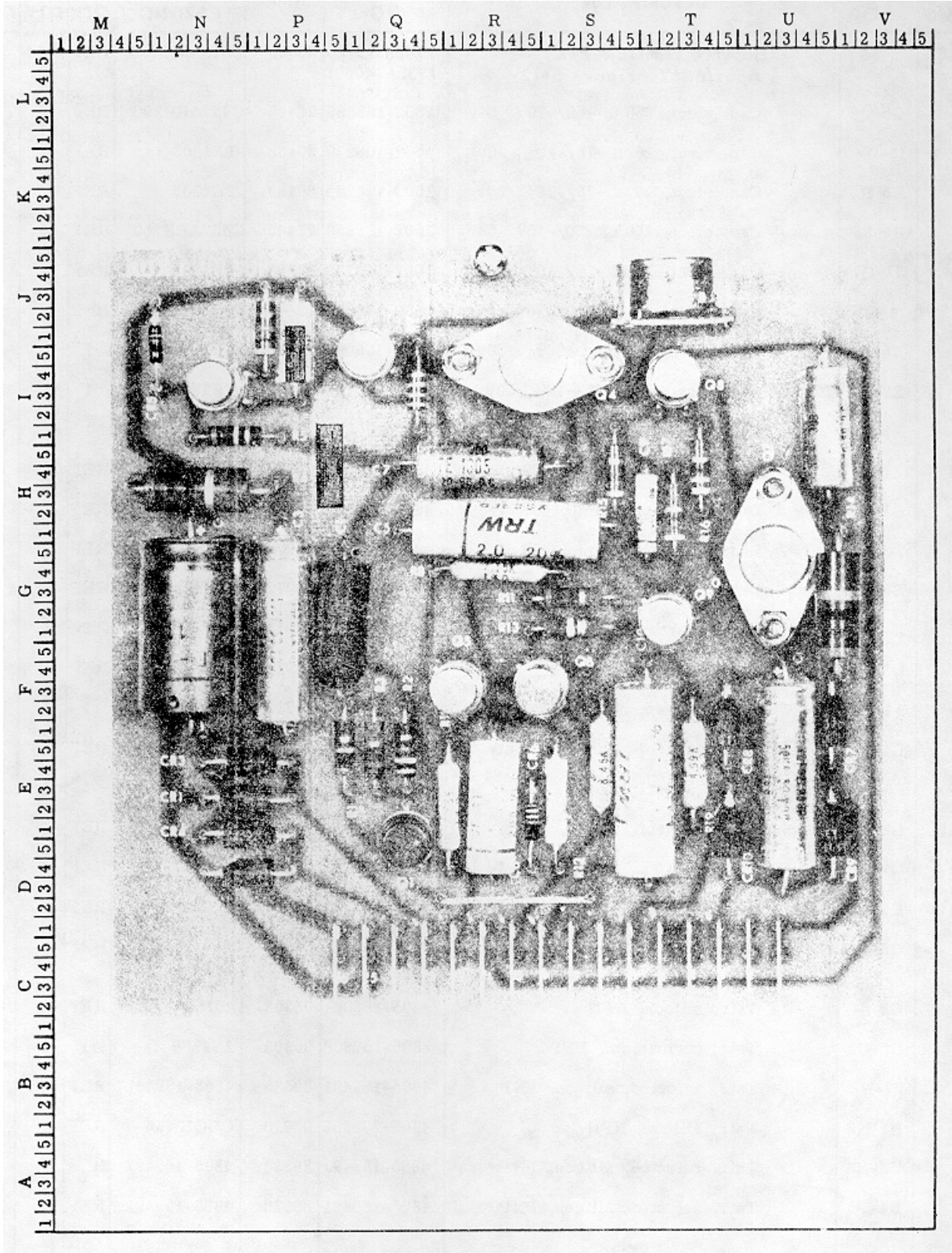

Figure 5-11. AUXILIARY POWER SUPPLY P/C ASSEMBLY

REF DESIG	INDEX NO	DESCRIPTION	STOCK NO	MFR	MFR PART NO	TOT QTY	REC QTY	USE CODE
A5A6		<b>CURRENT LIMITER P/C ASSEMBLY - Figure 5-12</b>	1702-219196 (335A-4060)	89536	1702-219196	REF		
C1	G5-Q2	Cap, elect, 250 uf +50/-10%, 64v	1502-185850	73445	C437ARH250	REF		
C2	13-U2	Cap, elect, 20 uf +75/-10%, 50v	1502-106229	80183	TE1305	REF		
C3	H5-R5	Cap, elect, 20 uf +75/-10%, 50v	1502-106229	80183	TE1305	REF		
C4	H5-S5	Cap, elect, 250 uf +50/-10%, 64v	1502-185850	73445	C437ARH250	REF		
C5	J1-U2	Cap, elect, 20 uf +75/-10%, 50v	1502-106229	80183	TE1305	REF		
C6	14-Q2	Cap, elect, 250 uf +50/-10%, 64v	1502-185850	73445	C437ARH250	REF		
C7	H5-N1	Cap, plstc, 0.047 uf ± 20%, 100v	1507-106096	72928	335B473M	1		
C9	E2-N3	Cap, elect, 2 uf +75/-10%, 50v	1502-105197	80183	TE1301	1	1	
C10	E5-Q5	Cap, elect, 160 uf +50/-10%, 64v	1502-170274	73445	C437ARH160	1	1	
CR1	E1-U4	Diode, silicon, 1 amp, 600 piv	4802-112383	05277	1N4822	REF		
CR2	E1-U2	Diode, silicon, 1 amp, 600 piv	4802-112383	05277	1N4822	REF		
CR3	F2-S3	Diode, silicon, 1 amp, 600 piv	4802-112383	05277	1N4822	REF		
CR4	E5-S3	Diode, silicon, 1 amp, 600 piv	4802-112383	05277	1N4822	REF		
CR5	I5-R1	Diode, zener, 36v	4803-186163	07910	1N974B	2		
CR6	D3-P1	Diode, zener, 3.9v	4803-113316	07910	1N748	REF		
CR7	J4-T3	Diode, zener, 36v	4803-237354	04713	1N3033A	1	1	
CR8	G1-Q5	Diode, silicon, 1 amp, 600 piv	4802-112383	05277	1N4822	REF		
CR9	12-P1	Diode, zener, 12v	4803-159780	07910	1N759	1		
CR10	G2-P3	Diode, silicon, 1 amp, 100 piv	4802-116111	05277	1N4817	REF		
CR11	I1-P1	Diode, silicon, 1 amp, 100 piv	4802-116111	05277	1N4817	REF		
CR12	F5-P3	Diode, silicon, 150 ma, 6 piv	4802-113308	0791C	CD13161	REF		
P1	C5-Q4	Connector, male, 16 contact	2816-187724	91662	D2-016-013- 5-200	REF		
Q1	G3-S4	Tstr, silicon, NPN	4805-183004	95303	40250	REF		
Q2	G5-U2	Tstr, germanium, PNP	4805-152868	95303	2N2869	1	1	
Q3	J1-N2	Tstr, selected, silicon, PNP	4805-159491	89536	4805-159491	REF		
Q4	H1-N3	Tstr, silicon, NPN	4805-203489	07910	CDQ10656	REF		
Q5	F2-N3	Tstr, selected, silicon, PNP	4805-159491	89536	4805-159491	REF		
Q6	D4-P5	Tstr, selected, silicon, PNP	4805-159491	89536	4805-159491	REF		



REF DESIG	INDEX NO	DESCRIPTION	STOCK NO	MFR	MFR PART NO	TOT QTY	REC QTY	USE CODE
Q7	E4-P5	Tstr, silicon, NPN	4805-203489	07910	CDQ10656	REF		
R1	E5-U2	Res, comp, 10 $\Omega$ $\pm$ 10%, 2w	4704-110163	01121	HB1001	4		
R2	H2-T3	Res, comp, 3. 3k $\pm$ 5%, 1/2w	4704-165761	01121	EB3325	REF		
RS	D3-T1	Res, comp, 150 $\Omega$ $\pm$ 5%, 2w	4704-235192	01121	HB1515	1		
R4	F3-U2	Res, comp, 100 $\pm$ 10%, 2w	4704-110163	01121	HB1001	REP		
R5	I5-R3	Res, comp, 3. 5k $\pm$ 5%, 1/2w	4704-165761	01121	EB93325	REF		
RS	D3-P2	Res, comp, 7. 5k $\pm$ 5%, 1/2w	4704-108910	01121	EB7525	3		
R7	H5-R1	Res, comp, 100k $\pm$ 10%, 1/2w	4704-108126	01121	EB1041	REF		
R8	F5-R4	Res, comp, 120 $\Omega$ $\pm$ 10%, 2w	4704-155531	01121	HB1211	4		
R9	E1-T1	Res, comp, 120 $\Omega$ $\pm$ 10%, 2w	4704-155531	01121	HB1211	REF		
R10	E2-Q1	Res, comp, 4.7k- $\pm$ 10%, 1/2w	4704-108381	01121	EB4721	REF		
R11	F1-P3	Res, comp, 10k $\pm$ 10%, 1/2w	4704-108118	01121	EB1031	REF		
R12	D3-N4	Res, comp, 10k $\pm$ 10%, 1/2w	4704-108118	01121	EB1031	REF		
R13	D3-N1	Res, comp, 16k $\pm$ 5%, 1/2w	4704-159632	01121	EB1635	REF		
R14	D3-N2	Res, comp, 1k $\pm$ 10%, 1/2w	4704-108563	01121	EB1021	REF		
R15	I3-P1	Res, comp, 2. 2k $\pm$ 10%, 1/2w	4704-108605	01121	EB2221	1		
R16	G2-N4	Res, comp, 100k $\pm$ 10%, 1/2w	4704-108126	01121	EB1041	REF		
R17	H4-P1	Res, comp, 36k $\pm$ 5%, 1/2w	4704-185991	01121	EB3635	REF		
R18	G2-N3	Res, comp, 330k $\pm$ 5%, 1/2w	4704-150201	01121	EB3345	1		
R19	G2-Q5	Res, comp, 7.5k $\pm$ 5%, 1/2w	4704-108910	01121	EB7525	REF		
R20	F4-P3	Res, comp, 7. 5k $\pm$ 5%, 1/2w	4704-108910	01121	EB7525	REF		
R21	F2-P3	Res, comp, 1k $\pm$ 10%, 1/2w	4704-108563	01121	EB1021	REF		
R22	J3-PI	Res, met flm, 12. 1k $\pm$ 1%, 1/2w	4705-182535	75042	Type CEC-TO	1		
R23	J5-N2	Res, var, ww, 10k $\pm$ 10%, 1-1/4w	4702-162115	71450	Type 110	1		
R24	J4-U3	Res, var, ww, 150 $\Omega$ $\pm$ 10%, 1-1/4w	4702-113092	71450	Type 110	1		
R25	E3-T2	Res, comp, 120 $\Omega$ $\pm$ 10%, 2w	4704-155531	01121	HB1211	REF		
R28	E2-R4	Res, comp, 120 $\Omega$ $\pm$ 10%, 2w	4704-155531	01121	HB1211	REF		
	F5-S2	Heat sink	4806-186759	89536	4806-186759	REF		
	H4-V1	Heat sink	4806-186742	89536	4806-186742	1		

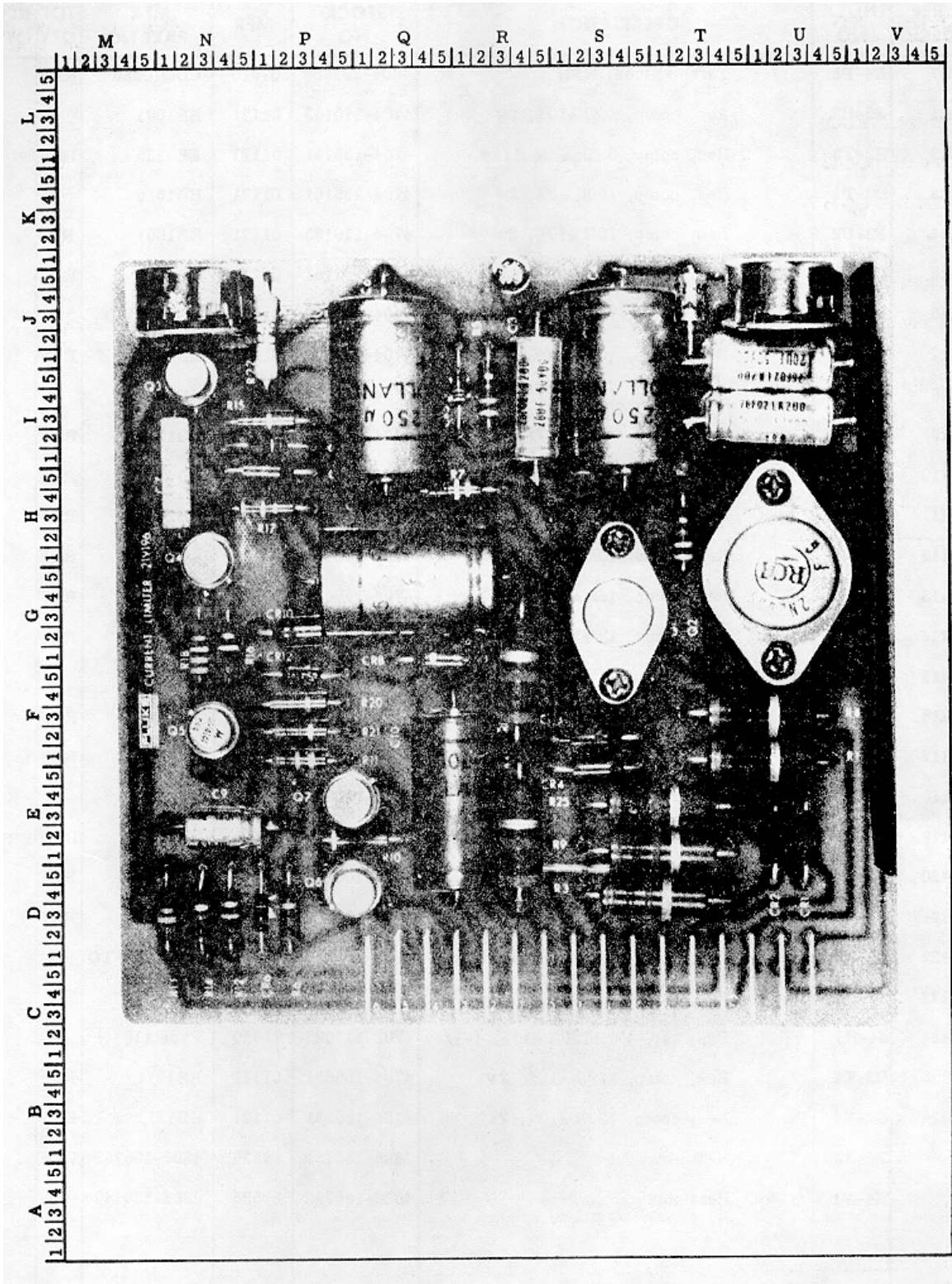

Figure 5-12. CURRENT LIMITER P/C ASSEMBLY

REF DESIG	INDEX NO	DESCRIPTION	STOCK NO	MFR	MFR PART NO	TOT QTY	REC QTY	USE CODE
A6		<b>TIME DELAY P/C ASSEMBLY</b> <b>Figure 5-13</b>	1702-192260 (332A-420)	89536	1702-192260	REF		
C2001	E1-J3	Cap, elect, 400 uf +50/-10%, 40v	1502-185868	73445	C437ARG400	1	1	
CR2001	C4-I3	Diode, silicon, 1 amp, 100 piv	4802-116111	05277	1N4817	REF		
CR2002	C1-I5	Diode, silicon, 1 amp, 100 piv	4802-116111	05277	1N4817	REF		
CR2003	C5-I1	Diode, silicon, 1 amp, 100 piv	4802-116111	05277	1N4817	REF		
K2001	C2-M2	Relay, armature, 12 vdc, dpdt	4504-176347	80089	62-760	1		
Q2001	E4-M2	Silicon controlled rectifier, 1.6 amp, 50v	4805-192567	03508	C-6F	REF		
R2001	AS-K5	Res, comp, 2. 2k ± 10%, 2w	4704-109967	01121	HB2221	2		
R2002	E3-K3	Res, comp, 5.6k±10%, 1/2w	4704-108324	01121	EB5621	1		
R2003	F2-L3	Res, comp, 390Ω ± 1r0%, 1/2w	4704-108365	01121	EB3911	1		
R2004	D4-K5	Res, comp, 10k ± 10%, 1/2w	4704-108118	01121	EB1031	REF		

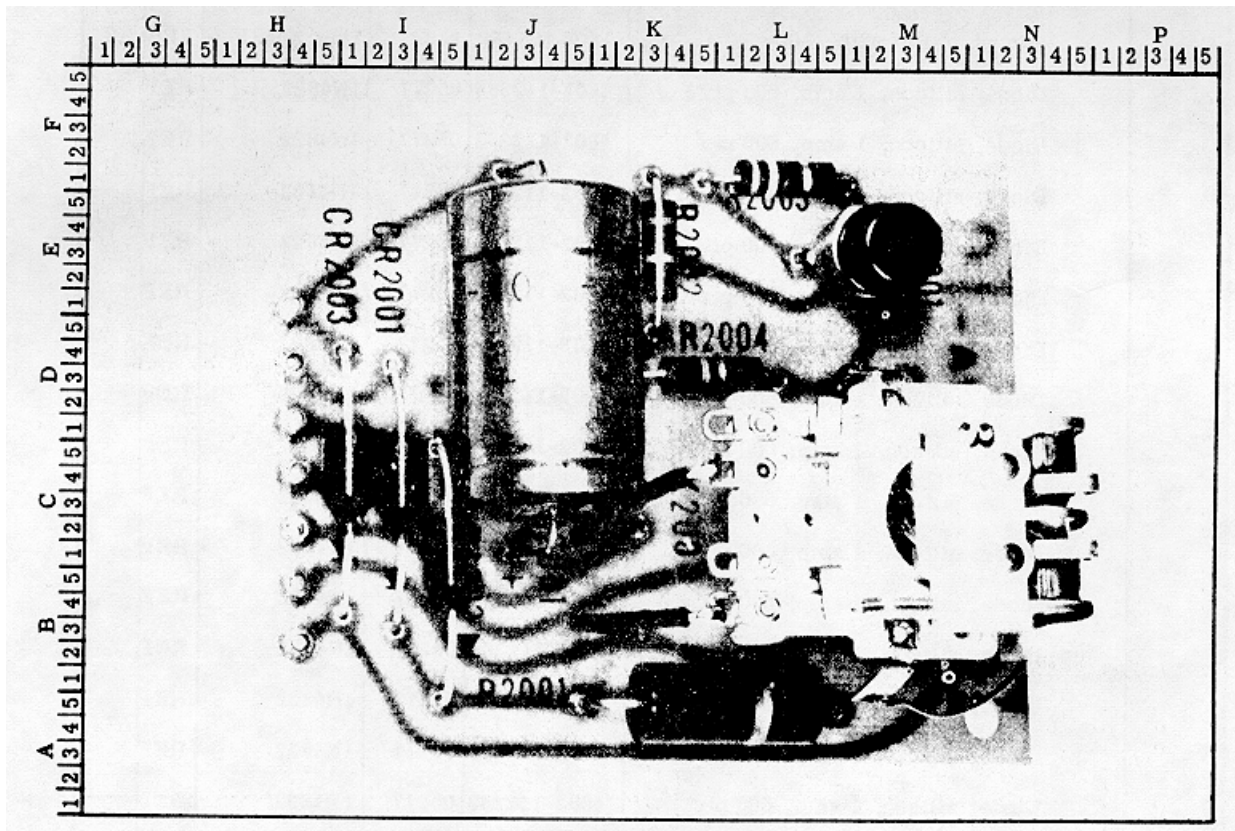

Figure 5-13. TIME DELAY P/C ASSEMBLY

REF DESIG	INDEX NO	DESCRIPTION	STOCK NO	MFR	MFR PART NO	TOT QTY	REC QTY	USE CODE
A7		<b>HIGH VOLTAGE MOTHER BOARD P/C ASSEMBLY - Figure 5-14</b>	1702-314831	89536	1702-314831	REF		
A7A1		Series Pass Element P/C Assembly (See Figure 5-15)	1702-314823	89536	1702-314823	REF		
A7A2		Preregulator P/C Assembly (See Figure 5-16)	1702-314815	89536	1702-314815	REF		
C1		Cap, elect, 125 uf +50/-10%, 450v	1502-106336	56289	Type 66D	3	1	
C2		Cap, elect, 125 uf +50/-10%, 450v	1502-106336	56289	Type 66D	REF		
C3		Cap, elect, 125 uf +50/-10%, 450v	1502-106336	56289	Type 66D	REF		
C4		Cap, elect, 8 uf +50/-10%, 450v	1502-194068	56289	39D805F450H- E4	2		
C5		Cap, elect, 8 uf +50/-10%, 450v	1502-194068	56289	39D805F450H- E4	REF		
C6		Cap, plstc, 1 uf ± 20%, 200v	1507-106450	84411	Type X663F	2		
C7		Cap, elect, 50 uf +75/-10%, 50v	1502-105122	80183	TE1307	1		
C8		Cap, cer, 0.001 uf *20%, 3 kv	1501-105635	80183	29C300	1		
C9		Cap, cer, 0.01 uf, gm, 1600v	1501-106930	71590	DD16-103	REF		G
C10		Cap, plstc, 1 uf ± 20%, 200v	1507-106450	84411	Type X663F	REF		
CR1		Diode, silicon, 1 amp, 600 piv	4802-112383	05277	1N4822	REF		
CR2		Diode, silicon, 1 amp, 600 piv	4802-112383	05277	1N4822	REF		
CR3		Diode, silicon, 1 amp, 600 piv	4802-112383	05277	1N4822	REF		
CR4		Diode, silicon, 1 amp, 600 piv	4802-112383	05277	1N4822	REF		
CR5		Diode, silicon, 1 amp, 600 piv	4802-112383	05277	1N4822	REF		
CR6		Diode, silicon, 1 amp, 600 piv	4802-112383	05277	1N4822	REF		
CR7		Diode, silicon, 1 amp, 600 piv	4802-112383	05277	1N4822	REF		
CR8		Diode, silicon, 1 amp, 600 piv	4802-112383	05277	1N4822	REF		
CR9		Diode, silicon, 1 amp, 600 piv	4802-112383	05277	1N4822	REF		
CR10		Diode, silicon, 1 amp, 600 piv	4802-112383	05277	1N4822	REF		
CR11		Diode, silicon, 1 amp, 600 piv	4802-112383	05277	1N4822	REF		
CR12		Diode, silicon, 1 amp, 600 piv	4802-112383	05277	1N4822	REF		
CR13		Diode, silicon, 1 amp, 600 piv	4802-112383	05277	1N4822	REF		
CR14		Diode, silicon, 1 amp, 600 piv	4802-112383	05277	1N4822	REF		
CR15		Diode, silicon, 1 amp, 600 piv	4802-112383	05277	1N4822	REF		

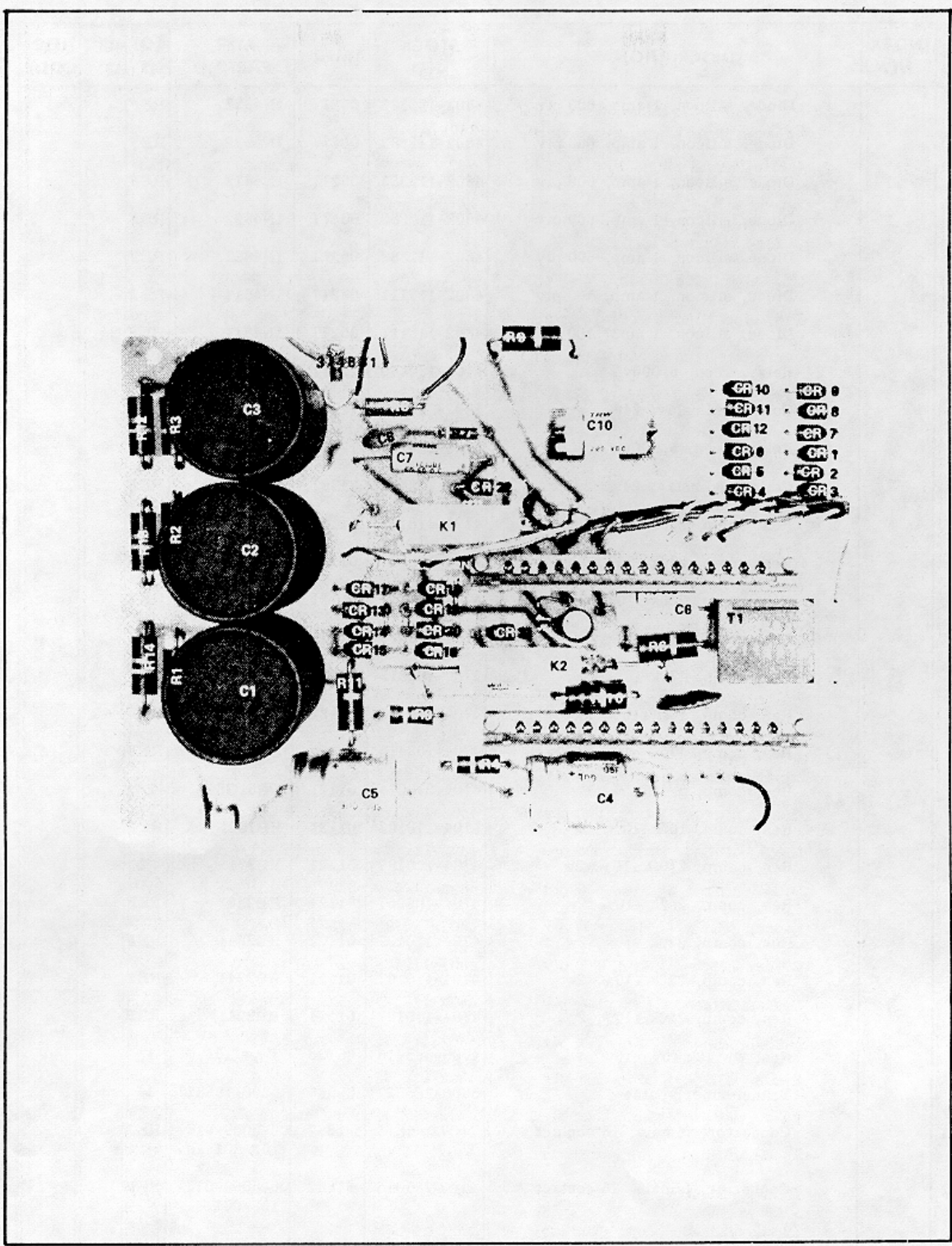









Figure 5-14. HIGH VOLTAGE MOTHER BOARD P/C ASSEMBLY

REF DESIG	INDEX NO	DESCRIPTION	STOCK NO	MFR	MFR PART NO	TOT QTY	REC QTY	USE CODE
CR16		Diode, silicon, 1 amp, 600 piv	4802-112383	05277	1N4822	REF		
CR17		Diode, silicon, 1 amp, 600 piv	4802-112383	05277	1N4822	REF		
CR18		Diode, silicon, 1 amp, 600 piv	4802-112383	05277	1N4822	REF		
CR13		Diode, silicon, 1 amp, 600 piv	4802-112383	05277	1N4822	REF		
CR20		Diode, silicon, 1 amp, 600 piv	4802-112383	05277	1N4822	REF		
CR21		Diode, silicon, 1 amp, 100 piv	4802-116111	05277	1N4817	REF		
CR22		Diode, silicon, 1 amp, 100 piv	4802-116111	05277	1N4817	REF		
K1		Relay, reed, 5, 000v	5103-184440	12617	DRVT-1	2		
		Coil, reed relay, 24v	1802-186155	71707	SP-24-P	REF		
K2		Relay, reed, 5, 000v	5103-184440	12617	DRVT-1	REF		
		Coil, reed relay, 24v	1802-186155	71707	SP-24-P	REF		
R1		Res, comp, 220k $\pm$ 10%, 2w	4704-110197	01121	HB2241	6		
R2		Res, comp, 220k $\pm$ 10%, 2w	4704-110197	01121	HB2241	REF		
R3		Res, comp, 220k $\pm$ 10%, 2w	4704-110197	01121	HB2241	REF		
R4		Res, comp, 470k $\pm$ 5%, 1w	4704-109819	01121	GB4745	2		
R5		Res, comp, 470k $\pm$ 5%, 1w	4704-109819	01121	GB4745	REF		
R6		Res, comp, 10 $\Omega$ $\pm$ 10%, 2w	4704-110163	01121	HB1001	REF		
R7		Res, comp, 470 $\Omega$ $\pm$ 10%, 1/2w	4704-108415	01121	EB4711	REF		
R8		Res, comp, 5. 1 $\Omega$ + 5%, 1w	4704-219071	01121	GB51G5	1		
R9		Res, comp, 10 $\Omega$ $\pm$ 10%, 2w	4704-110163	01121	HB1001	REF		
R10		Res, comp, 2701 $\pm$ 10%, 2w	4704-110189	01121	HB2711	1		
R11		Res, comp, 2. 2k $\pm$ 10%, 2w	4704-109967	01121	HB2221	REF		
R12		Res, comp, 220k $\pm$ 10%, 2w	4704-110197	01121	HB2241	REF		
R13		Res, comp, 220k $\pm$ 10%, 2w	4704-110197	01121	HB2241	REF		
R14		Res, comp, 220k $\pm$ 10%, 2w	4704-110197	01121	HB2241	REF		
R15		Res, ww, 2k $\pm$ 5%, 10w	4706-155416	06136	Type 10F	1		
T1		Transformer, pulse	5600-185827	89536	5600-185827	1		
XA7A1		Connector, female, 16 contact	2107-285015	91662	00-5009-016-153-001	REF		
XA7A2		Connector, female, 16 contact	2107-285015	91662	00-5009-016-153-001	REF		

REF DESIG	INDEX NO	DESCRIPTION	STOCK NO	MFR	MFR PART NO	TOT QTY	REC QTY	USE CODE
A7A1		<b>SERIES PASS ELEMENT P/C ASSEMBLY - Figure 5-15</b>	1702-314823	89536	1702-314823	REF		
C1		Cap, cer, 0.05 uf +80/-10%, 500v	1501-105676	56289	33C58B	6		
C2		Cap, elect, 8 uf +50/-10%, 450v	1502-194068	56289	39D805F450- HE4	REF		
C3		Cap, mylar, .0022uf ± 10%, 50v	1507-313239	06001	75FIR5A224	1		
C4		Cap, cer, 0.005 uf ± 20%, 100v	1501-175232	56289	C023BI01E- 802M	1		S
C5		Cap, elect, 20 uf +50/-10%, 16v	1502-241356	73445	C426ARE20	1		
CR1		Diode, silicon, 1 amp, 600 piv	4802-112383	05277	1N4822	17		
CR2		Diode, silicon, 1 amp, 600piv	4802-112383	05277	1N4822	REF		
CR3		Diode, silicon, 1 amp, 600 piv	4802-112383	05277	1N4822	REF		
CR4		Diode, silicon, 1 amp, 600 piv	4802-112383	05277	1N4822	REF		
CR5		Diode, silicon, 1 amp, 600 piv	4802-112383	05277	1N4822	REF		
CR6		Diode, zener, ± 5%, 16v	4809-313221	12969	UZ8716	1	1	
CR7		Diode, silicon, 1 amp, 600 piv	4802-112383	05277	1N4822	REF		
CR8		Diode, silicon, 1 amp, 600 piv	4802-112383	05277	1N4822	REF		
CR9		Diode, silicon, 1 amp, 600 piv	4802-112383	05277	1N4822	REF		
CR10		Diode, silicon, 1 amp, 600 piv	4802-112383	05277	1N4822	REF		
CR11		Diode, silicon, 1 amp, 600 piv	4802-112383	05277	1N4822	REF		
CR12		Diode, silicon, 1 amp, 600 piv	4802-112383	05277	1N4822	REF		
CR13		Diode, silicon, 1 amp, 600 piv	4802-112383	05277	1N4822	REF		
CR14		Diode, silicon, 1 amp, 600piv	4802-112383	05277	1N4822	REF		
CR15		Diode, silicon, 1 amp, 600 piv	4802-112383	05277	1N4822	REF		
CR16		Diode, silicon, 1 amp, 600 piv	4802-112383	05277	1N4822	REF		
CR17		Diode, silicon, 1 amp, 600 piv	4802-112383	05277	1N4822	REF		
CR18		Diode, zener, 20v	4803-113340	07910	1N968A	1	1	
CR19		Diode, zener, 36v	4803-186163	07910	1N974B	REF		
CR20		Diode, silicon, 1 amp, 100 piv	4802-116111	05277	1N4817	3		
CR21		Diode, silicon, 1 amp, 100 piv	4802-116111	05277	1N4817	REF		
CR22		Diode, zener, 6. 2v	4803-180497	07910	1N753	1	1	
CR23		Diode, zener, 200v	4803-217422	04713	1N3051A	8	1	
CR24		Diode, zener, 200v	4803-217422	04713	1N3051A	REF		

REF DESIG	INDEX NO	DESCRIPTION	STOCK NO	MFR	MFR PART NO	TOT QTY	REC QTY	USE CODE
CR25		Diode, zener, 200v	4803-217422	04713	1N3051A	REF		
CR26		Diode, zener, 200v	4803-217422	04713	1N3051A	REF		
CR27		Diode, zener, 200v	4803-217422	04713	1N3051A	REF		
CR28		Diode, zener, 200v	4803-217422	04713	1N9051A	REF		
CR29		Diode, zener, 200v	4803-217422	04713	1N3051A	REF		
CR30		Diode, zener, 200v	4803-217422	04713	1N3051A	REF		
CR31		Diode, silicon, 1 amp, 600 piv	4802-112383	05277	1N4822	REF		
CR32		Diode, silicon, 1 amp, 100 piv	4802-116111	05277	1N4817	REF		
P1		Connector, male, 16 contact	2816-187724	91662	02-016-013- 5-200	REF		
Q1		Tstr, silicon, NPN				8	8	
Q2		Tstr, silicon, NPN				REF		
Q3		Tstr, silicon, NPN				REF		
Q4		Tstr, silicon, NPN				REF		
Q5		Tstr, silicon, NPN				REF		
Q6		Tstr, silicon, NPN				REF		
Q7		Tstr, silicon, NPN				REF		
Q8		Tstr, silicon, NPN				REF		
Q9		Tstr, silicon, unijunction	4805-117176	03508	2N167A	1	1	
Q10		Tstr, silicon, NPN	4805-203489	07910	CDQ10656	REF		
R1		Res, comp, 1.8k ± 10%, 2w	4704-185983	01121	HB1821	3		
R2		Res, comp, 1.8k ± 10%, 2w	4704-185983	01121	HB1821	REF		
R3		Res, comp, 1.8k ± 10%, 2w	4704-185983	01121	HB1821	REF		
R4		Res, comp, 62k ± 5%, 1/2w	4704-108522	01121	EB6235	2		
R5		Res, comp, 100k ± 10%, 2w	4704-158659	01121	HB1041	1		
R6		Res, comp, 56k ± 5%, 1/2w	4704-219048	01121	EB5635	1		
R7		Res, comp, 1k ± 5%, 1/2w	4704-108597	01121	EB1025	REF		
R8		Res, comp, 62k ± 5%, 1/2W	4704-108522	01121	EB6235	REF		
R9		Res, comp, 1k ± 5%, 1/2w	4704-108597	01121	EB1025	REF		
R10		Res, comp, 68k ± 5%, 1/2w	4704-159624	01121	EB6835	1		
R11		Res, comp, 1k ± 5%, 1/2w	4704-108597	01121	EB1025	REF		



REF DESIG	INDEX NO	DESCRIPTION	STOCK NO	MFR	MFR PART NO	TOT QTY	REC QTY	USE CODE
R12		Res, comp, 75k $\pm$ 5%, 1/2w	4704-108928	01121	EB7535	REF		
R1		Res, comp, 1k $\pm$ 5%, 1/2w	4704-108597	01121	EB1025	REF		
R14		Res, comp, 82k $\pm$ 5%, 1/2w	4704-195966	01121	EB8235	1		
R15		Res, comp, 1k $\pm$ 5%, 1/2w	4704-108597	01121	EB1025	REF		
R16		Res, comp, 91k $\pm$ 5%, 1/2w	4704-219030	01121	EB9135	1		
R17		Res, comp, 1k $\pm$ 5%, 1/2w	4704-108597	01121	EB1025	REF		
R18		Res, comp, 100k $\pm$ 5%, 1/2w	4704-168054	0112	EB1045.	9		
R19		Res, comp, 1k $\pm$ 5%, 1/2w	4704-108597	01121	EB1025	REF		
R20		Res, comp, 1.1 $\Omega$ $\pm$ 65%, 1/2w	4704-163717	01121	EB1G5	1		
R21		Res, comp, 100k $\pm$ 5%, 1/2w	4704-168054	01121	EB1045	REF		
R22		Res, comp, 100k $\pm$ 5%, 1/2w	4704-168054	01121	EB1045	REF		
R23		Res, comp, 100k $\pm$ 5%, 1/2w	4704-168054	01121	EB1045	REF		
R24		Res, comp, 100k $\pm$ 5%, 1/2w	4704-168054	01121	EB1045	REF		
R25		Res, comp, 100k $\pm$ 5%, 1/2w	4704-168054	01121	EB1045	REF		
R26		Res, comp, 100k $\pm$ 5%, 1/2w	4704-168054	01121	EB1045	REF		
R27		Res, comp, 100k $\pm$ 5%, 1/2w	4704-168054	01121	EB1045	REF		
R28		Res, comp, 22k $\pm$ 10%, 2w	4704-109975	01121	HB2231	7		
R29		Res, comp, 22k $\pm$ 10%, 2w	4704-109975	01121	HB2231	REF		
R30		Res, comp, 22k $\pm$ 10%, 2w	4704-109975	01121	RB2231	REF		
R31		Res, comp, 22k $\pm$ 10%, 2w	4704-109975	01121	HB2231	REF		
R32		Res, comp, 22k $\pm$ 10%, 2w	4704-109975	01121	HB2231	REF		
R33		Res, comp, 22k $\pm$ 10%, 2w	4704-109975	01121	HB2231	REF		
R34		Res, comp, 22k $\pm$ 10%, 2w	4704-109975	01121	HB2231	REF		
R35		Res, comp, 75k $\pm$ 5%, 1/2w	4704-108928	01121	EB7535	REF		
R36		Res, comp, 5.1k $\pm$ 5%, 1/4w	4704-193342	01121	CB5125	REF		
R37		Res, comp, 36k $\pm$ 5%, 1/2w	4704-185991	01121	EB3635	REF		
R38		Res, comp, 180 $\Omega$ $\pm$ 5%, 1/2w	4704-108944	01121	EB1815	2		
R39		Res, comp, 1.1k $\pm$ 5%, 1/4w	4704-267336	01121	CB1125	REF		
R40		Res, comp, 100k $\pm$ 5%, 1/2w	4704-168054	01121	EB1045	REF		
R41		Res, comp, 5.1k $\pm$ 5%, 1/4w	4704-193342	01121	CB5125	2	S	

REF DESIG	INDEX NO	DESCRIPTION	STOCK NO	MFR	MFR PART NO	TOT QTY	REC QTY	USE CODE
R42		Res, comp, 1k ± 5%, 1/2w	4704-108577	01121	EB1025	REF		S
R43		Res, comp, 5.1k ± 5%, 1/4w	4704-193342	01121	CB5125	REF		
		Heat sink	4806-192245	89536	4806-192245	1		
L1		Inductance, 2.2 MH	1801-147801	72259	WEE-2, 200	2		
L2		Inductance, 2.2 MH	1801-147801	72259	WEE-2, 200	REF		
L3		Inductance, 220 uh	1801-147835	72259	WEE-220	1		
Q11		Tstr, silicon NPN	4819-218396	04713	2N3904			
Q12		Tstr, silicon NPN	4819-177105	07263	2N3565			

5 Q1 thru Q8 may be Fluke Part No. 4805-190710, Mfr 04713, Mfr Part No. 2N3739; or Fluke Part No. 4805-225573 , Mfr 95303, Mfr Part No. 2N4299. It is necessary, however, that all eight must be the same type. Example; if all eight are 2N4299, a replacement of one or more should be a 2N4299.

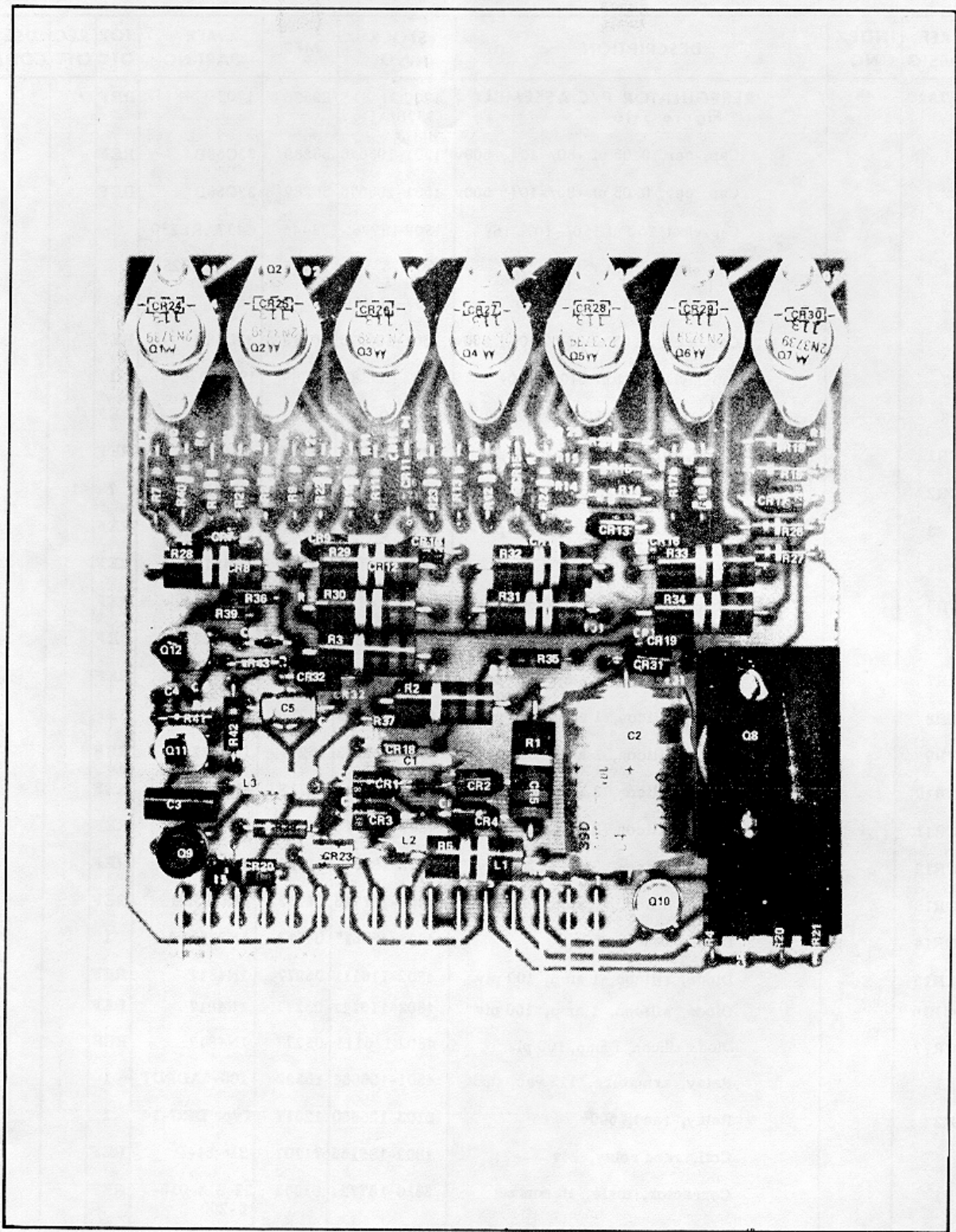

Figure 5-15. SERIES PASS ELEMENT P/C ASSEMBLY

REF DESIG	INDEX NO	DESCRIPTION	STOCK NO	MFR	MFR PART NO	TOT QTY	REC QTY	USE CODE
A7A2		<b>PREREGULATOR P/C ASSEMBLY</b> <b>Figure 5-16</b>	1702-314815 (332B/AF- 4082)	89536	1702-314815	REF		
C1		Cap , cer, 0.05 uf +80/-10%, 500v	1501 -105676	56289	33C58B	REF		
C2		Cap , cer, 0.05 uf +80/-10%, 500v	1501 -105676	56289	33C58B	REF		
C3		Cap , elect, 250 uf +50/- 10%, 16v	1502-187765	73445	C437ARE250			
C4		Cap , elect, 250 uf +50/-10%, 16v	1502-187765	73445	C437ARE250			
C5		Cap , mylar, 1.0 uf ±20%, 200v	1507-106450	72928	364	1		
C6		Cap , cer, 0.05 uf +80/-10%, 500v	1501 -105676	56289	33C58B	REF		
C7		Cap , mylar, .001 uf ±10%, 200v	1507-159582	56289	192P10292	1		
C8		Cap , cer, 0.05 uf +80/-10%, 500v	1501-105676	56289	33C58B	REF		
CR1		Diode , silicon, 1 amp, 100 piv	4802-116111	05277	1N4817	REF		
CR2		Diode , silicon, 1 amp, 100 piv	4802-116111	052 77	1N4817	7	1	
CR3		Diode , silicon, 1 amp, 100 piv	4802-116111	052 77	1N4817	REF		
CR4		Diode , silicon, 1 amp, 100 piv	4802-116111	052 77	1N4817	REF		
CR5		Diode , silicon, 1 amp, 100 piv	4802-116111	052 77	1N4817	REF		
CR6		Diode , silicon, 1 amp, 600 piv	4802-112383	052 77	1N4822	REF		
CR7		Diode , silicon, 1 amp, 600 piv	4802-112383	052 77	1N4822	REF		
CR8		Diode , silicon, 1 amp, 600 piv	4802-112383	052 77	1N4822	REF		
CR9		Diode , silicon, 1 amp, 600 piv	4802-112383	052 77	1N4822	REF		
CR10		Diode , silicon, 3 amp, 200 piv	4802-187716	047 13	MR10S32B	REF		
CR11		Diode , silicon, 3 amp, 200 piv	4802-187716	047 13	MR1032B	REF		
CR12		Diode , silicon, 3 amp, 200 piv	4802-187716	047 13	MR1032B	REF		
CR13		Diode , silicon, 3 amp, 200 piv	4802-187716	047 13	MR1032B	REF		
CR14		Diode , zener, 200v	4803-187617	047 13	1N3350RA	1	1	
CR15		Diode , silicon, 1 amp, 100 piv	4802-116111	052 77	1N4817	REF		
CR16		Diode , silicon, 1 amp, 100 piv	4802-116111	052 77	1N4817	REF		
CR17		Diode , silicon, 1 amp, 100 piv	4802-116111	052 77	1N4817	REF		
K1		Relay, armature, 115 vac, dpdt	4501-106864	16332	100-SADPDT	1		
K2		Relay, reed, 500v	5103-136630	12617	Type DRG-1	1		
		Coil, reed relay, 24v	1802-186155	71707	8P-24-P	REF		
P1		Connector, male, 16 contact	2816-187714	91662	02-016-013- 5-200	REF		

REF DESIG	INDEX NO	DESCRIPTION	STOCK NO	MFR	MFR PART NO	TOT QTY	REC QTY	USE CODE
Q1		Tstr, silicon, NPN	4805-193953	05277	320C034H31	1	1	
Q2		Tstr, silicon, NPN	4811-261347	16758	Type DTS410	1		
Q3		Tstr, tested, silicon, NPN	4819-203489	07910	CDQ 10656	REF		
Q4		Tstr, tested, silicon, PNP	4805-159491	89536	4805-159491	REF		
Q5		Tstr, silicon, NPN	4805-203489	07910	CDQ10656	REF		
Q6		Tstr, tested, silicon, PNP	4805-159491	89536	4805-159491	REF		
Q7		Tstr, silicon, NPN	4805-203489	07910	CDQ10656	REF		
Q8		Tstr, silicon, PNP	4805-159491	89536	4805-159491	REF		
Q9		Tstr, silicon, PNP	4805-159491	89536	4805-159491	REF		
R1		Res, comp, 68 $\Omega$ $\pm$ 10%, 2w	4704-110205	01121	HB6801	1		
R2		Res, ww, 0.192 $\Omega$ $\pm$ 1%, 3w	4707-238741	89536	4707-238741	1	1	
R4		Res, ww, 1k $\pm$ 5%, 5w	4706-113282	63743	Type 5F1000	1		
R5		Res, comp, 22k $\pm$ 5%, 1/2w	4704-186064	01121	EB2235	REF		
R6		Res, ww, 1 $\Omega$ $\pm$ 10%, 5w	4706-112425	44655	ID48F	1		
R7		Res, comp, 220 $\Omega$ $\pm$ 10%, 1/2w	4704-108191	01121	EB2211	1		
R8		Res, comp, 430 $\Omega$ $\pm$ 5%, 1/2w	4704-109058	01121	EB4315	1		
R9		Res, comp, 100 $\Omega$ $\pm$ 5%, 1/2w	4704-188508	01121	EBI015	REF		
R10		Res, comp, 2.2k $\pm$ 5%, 1/2w	4704-108506	01121	EB2035	REF		
R11		Res, comp, 100 $\Omega$ $\pm$ 5%, 1/2w	4704-188508	01121	EB1015	REF		
R12		Res, comp, 1k $\pm$ 5%, 1/2w	4704-108597	01121	EB1025	REF		
R13		Res, comp, 1k $\pm$ 5%, 1/2w	4704-108597	01121	EB1025	2		
R14		Res, comp, 1k $\pm$ 5%, 1/2w	4704-108597	01121	EB1025	REF		
R15		Res, comp, 4.7k $\pm$ 5%, 1/2w	4704-108886	01121	EB4725	1		
R16		Res, comp, 3.3k $\pm$ 5%, 1/2w	4704-165761	01121	EB3325	REF		
R17		Res, comp, 1k $\pm$ 5%, 1/2w	4704-108597	01121	EB1025	REF		
R18		Res, comp, 560 $\Omega$ $\pm$ 5%, 1/2w	4704-109121	01121	EB5615	1		
R19		Res, comp, 68 $\Omega$ $\pm$ 5%, 1/2w	4704-178384	01121	FB6805	1		
		Heat sink	4841-314807	8953G	4841-314807	1		



## REPAIR PARTS LIST

### Introduction

This section lists repair parts that are required for maintenance of Dc Voltage Calibrator, John Fluke Models 332B/AF and 332B/D and is applicable to Army Area Calibration Laboratories (AACL's) and Army Area Calibration Teams (AACT's).

#### NOTE

**Throughout this section, DS is used to indicate AACT, and GS is used to indicate AACL.**

### General

This section is divided as follows:

- (1) Repair Parts List. A list, in alphabetical sequence, of repair parts authorized for the performance of maintenance at the AACT and AACL support levels.
- (2) National Stock Number and Reference Number Index. A list, in ascending numerical sequence, of all National stock numbers (NSN's) appearing in the repair parts list, followed by a list of all reference numbers in alpha-numeric sequence appearing in the list. The NSN's and reference numbers are cross-referenced to a figure number and item number in column 1.

#### NOTE

**The figure and item number columns represent cross-reference numbers, since illustrations are not included in this section.**

Refer to section I of TM 9-4931-700-34P for explanation of columns (para 3), special information (para 4, except for subparagraph 40 which is not applicable to this section), and abbreviations (para 6).

### How to Locate Repair Parts

When NSN or reference number is unknown, use the repair parts listing and locate the item by description.

When National stock number or reference number is known, use the list of NSN's or the reference numbers and locate the cross-referenced figure and item numbers. Locate the cross-referenced figure and item number under column 1 of the repair parts list for the complete description of the repair part.

REPAIR PARTS LIST

(1) ILLUSTRATION (a) FIG NO.		(2) SMR CODE	(3) NATIONAL STOCK NUMBER	(4) PART NUMBER	(5) FSCM	(6) DESCRIPTION  USABLE ON CODE	(7) U/M	(8) QTY INC IN UNIT
						GROUP 2178 CALIBRATOR, VOLTAGE 332BAF 89536		
						MAINFRAME ASSEMBLY CONSISTING OF		
	3	PAHZZ	5910-00-686-6428	913-3533-00	13499	CAPACITOR, FIXED, CERAMIC DIELECTRIC	EA	1
	5	PAHZZ	5910-00-988-4809	29C300	56289	CAPACITOR, FIXED, CERAMIC DIELECTRIC 3000 V DC, 100 UUF(+ -20 0/0)	EA	1
1	3	PDFFL	4931-00-402-6834	1702-314815	89536	CIRCUIT CARD ASSEMBLY CONSISTING OF	EA	1
1	5	PAFZZ	5910-00-965-9728	192P10252	56289	CAPACITOR, FIXED, PLASTIC DIELECTRIC 200 V, 1, 000 UUF(+ -10 0/0)	EA	1
1	7	PAFZZ	5905-00-415-1576	EB2735	01121	RESISTOR, FIXED, COMPOSITION	EA	1
2	3	PAFZZ	4931-00-402-6841	1702-219154	89536	CIRCUIT CARD ASSEMBLY CONSISTING OF	EA	1
2	5	PAFZZ	5913-00-928-5631	K15C20K	05397	CAPACITOR, FIXED, ELECTROLYTIC	EA	2
2	7	PAFZZ	5910-00-930-4B50	K2R2C20K	05397	CAPACITOR, FIXED, ELECTROLYTIC 20 V DC, 2.2 UF (+ - 10 0/0)	EA	1
2	9	PAFZZ	5910-00-013-2493	C280AEP470K	73445	CAPACITOR, FIXED, PLASTIC	EA	1
2	11	PAFZZ	5905-00-807-7506	EB6215	01121	RESISTOR, FIXED, COMPOSITION	EA	2
2	13	PAFZZ	5905-00-052-8396	EB2425	01121	RESISTOR, FIXED, COMPOSITION	EA	1
2	15	PAFZZ	5905-00-104-8336	RCR20G104JS	81349	RESISTOR, FIXED, COMPOSITION ½ W , 100, 000 OHMS, TYPE RCR20G104JS (+ - 5 0/0)	EA	1
2	17	PAFZZ	5905-00-10-8340	RCR20G363JS	81349	RESISTOR, FIXED, COMPOSITION ½ W , 36, 000 OHMS TYPE RCR20G363JS (+ - 5 0/0)	EA	4
2	19	PAFZZ	5905-00-106-1245	RCR32G272JS	81349	RESISTOR, FIXED, COMPOSITION 1 W, 2, 700 OHMS, TYPE RCR32G272JS (+ - 5 0/0)	EA	1
2	21	PAFZZ	5905-00-415-0596	EB2025	01121	RESISTOR, FIXED, COMPOSITION	EA	3
2	23	PAFZZ	5905-00-141-0596	RCR20G473JS	81349	RESISTOR, FIXED, COMPOSITION 1/2 w, 47, 000 OHMS, TYPE RCR20G473JS (+ - 5 0/0)	EA	2
2	25	PAFZZ	5905-00-11-0310	RCR20G392JS	81349	RESISTOR, FIXED, COMPOSITION 1/2 W , 3, 900 OHMS, TYPE RCR20CG392JS (+ - 5 0/0)	EA	1
2	27	PAFZZ	5905-00-256-0412	RC42GF181J	81349	RESISTOR, FIXED, COMPOSITION 2 w , 180 OHMS, TYPE RC42GF181J (+ - 5 0/0)	EA	1
2	29	PAFZZ	5905-00-279-3521	RC42GF470J	81349	RESISTOR, FIXED, COMPOSITION 2 W , 47 OHMS, TYPE RC42GF470J (+ - 5 0/0)	EA	2



(1) ILLUSTRATION		(2)	(3)	(4)	(5)	(6) DESCRIPTION	(7)	(8)
(a) FIG NO.	(b) ITEM NO.	SMR CODE	NATIONAL STOCK NUMBER	PART NUMBER	FSCM	USABLE ON CODE	U/M	QTY INC IN UN
2	33	PAFZZ	5905-00-141-0600	RCR20CG822JS	81349	RESISTOR, FIXED, COMPOSITION 1/2 W , 8, 200 OHMS, TYPE RCR20G822JS (+ - 5 0/0)	EA	2
2	35	PAFZZ	5905-00-141-1187	RCR20G203JS	81349	RESISTOR, FIXED, COMPOSITION 1/2 W , 20, 000 OHMS, TYPE RCR20G822JS (+ - 5 0/0)	EA	3
2	37	PAFZZ	5905-00-141-1187	RCR20G203J	81349	RESISTOR, FIXED, COMPOSITION 1/2 W , 20, 000 OHMS, TYPE RCR20G203JS (+ - 5 0/0)	EA	3
2	39	PAFZZ	5935-00-104-350	RCR20G221JS	81349	RESISTOR, FIXED, COMPOSITION 1/2W , 220 OHMS, TYPE RCR20GF221JS (+ - 5 0/0)	EA	1
2	41	PAFZZ	5961-00-971-1701	CD13161	07910	SEMICONDUCTOR DEVICE, DIODE	EA	5
2	43	PAFZZ	5961-00-986-3161	1N961A	07910	SEMICONDUCTOR DEVICE, DIODE	EA	3
2	45	PAFZZ	5961-00-892-0734	JAN1N483B	81349	SEMICONDUCTOR DEVICE, DIODE TYPE 1N4838	EA	2
2	47	PAFZZ	5961-00-883-6064	JAN1N749A	81349	SEMICONDUCTOR DEVICE, DIODE TYPE JAN1N749A	EA	1
2	49	PAFZZ	5961-00-669-6888	JAN1N277	81349	SEMICONDUCTOR DEVICE, DIODE TYPE 1N277	EA	1
2	51	PAFZZ	5961-00-450-5101	4805-159491	89536	TRANSISTOR	EA	11
3	3	PAFH	4931-00-402-6837	1702-219162	89536	CIRCUIT CARD ASSEMBLY CONSISTING OF	EA	1
3	5	PAFZZ	5910-00-235-9116	C437ARG25D	73445	CAPACITOR, FIXED, ELECTROLYTIC	EA	1
3	7	PAFZZ	5905-00-087-1160	EB5115	01121	RESISTOR, FIXED, COMPOSITION	EA	1
3	9	PAFZZ	5905-00-126-0529	EB6225	01121	RESISTOR, FIXED, COMPOSITION	EA	3
3	11	PAFZZ	5905-00-104-8348	RCR20C332JS	81349	RESISTOR, FIXED, COMPOSITION 1/2 w , 3.300 OHMS, TYPE RCR20G332JS (+ - 5 0/0)	EA	4
3	13	PAFZZ	5935-00-110-0196	RCR20G102JS	81349	RESISTOR, FIXED, COMPOSITION 1/2 W , 1, 000 OHMS, TYPE RCR20G102JS (+ - 5 0/0)	EA	10
3	15	PAFZZ	5905-00-141-0592	RCR20G122JS	81349	RESISTOR, FIXED, COMPOSITION 1/2 W , 1, 200 OHMS, TYPE RCR20G122JS (+ - 5 0/0)	EA	1
3	17	PAFZZ	59C5-CC-11-5411	RCR20G302JS	81349	RESISTOR, FIXED, COMPOSITION 1/2 3, 000 OHMS, TYPE RCR20G302JS (+ - 5 0/0)	EA	2
3	19	PAFZZ	5905-00-141-0591	RCR20G103JS	81349	RESISTOR, FIXED, COMPOSITION 1/2 W , 10, 000 OHMS, TYPE RCR20G103JS (+ - 5 0/0)	EA	2
3	21	PAFZZ	5905-00-246-9396	RCR20G226JS	81349	RESISTOR, FIXED, COMPOSITION 1/2 W , 22 MEG, TYPE RCR20G226JS (+ - 5 0/0)	EA	1
3	23	PAFZZ	5905-00-141-1168	RCR20G222JS	81349	RESISTOR, FIXED, COMPOSITION 1/2 W , 2, 200 OHMS, TYPE RCR20G222JS (+ - 5 0/0)	EA	2
3	25	PAFZZ	5905-00-106-9344	RCR20G101JS	81349	RESISTOR, FIXED, COMPOSITION 1/2 W , 100 OHMS, TYPE RCR20G101JS (+ - 5 0/0)	EA	6
3	27	PAFZZ	5905-00-106-1282	RCR20G223JS	81349	RESISTOR, FIXED, COMPOSITION 1/2 W 22, 000 OHMS, TYPE RCR20G223JS (+ - 5 0/0)	EA	3
3	29	PAFZZ	5961-00-932-0553	U1249	15818	TRANSISTOR	EA	2
3	31	PAFZZ	5961-00-413-0304	4805-168716	89536	TRANSISTOR	EA	2
3	33	PAFZZ	5961-00-943-9407	JAN2N3250A	81349	TRANSISTOR	EA	3
3	35	PAFZZ	5961-00-930-5325	2N3565	49956	TRANSISTOR	EA	5
4	3	PAFH	4931-00-402-6836	1702-219188	89536	CIRCUIT CARD ASSEMBLY	EA	1

(1) ILLUSTRATION		(2)	(3)	(4)	(5)	(6) DESCRIPTION	(7)	(8)
(a) FIG NO.	(b) ITEM NO.	SMR CODE	NATIONAL STOCK NUMBER	PART NUMBER	FSCM	USABLE ON CODE	U/M	QTY INC IN UNIT
4	5	PAFZZ	5910-00-929-2621	K68C15K	05397	CONSISTING OF		
4	7	PAFZZ	5910-00-994-6910	C437ARH250	73445	CAPACITOR, FIXED, ELECTROLYTIC	EA	1
4	9	PAFZZ	5910-00-936-0577	192P12292	56289	CAPACITOR, FIXED, ELECTROLYTIC	EA	4
4	11	PAFZZ	5905-00-141-1116	RCR20G562JS	81349	CAPACITOR, FIXED, PLASTIC DIELECTRIC	EA	1
4	13	PAFZZ	5905-00-141-0595	RCR20G472JS	81349	RESISTOR, FIXED, COMPOSITION	EA	1
						RESISTOR, FIXED, COMPOSITION 1/2 W , 4, 700	EA	2
						OHMS, TYPE RCR20G472JS (+ - 5 0/0)		
4	15	PAFZZ	5905-00-249-4210	RC42GF123J	81349	RESISTOR, FIXED, COMPOSITION 2 W , 12, 000	EA	1
						OHMS, TYPE RC42GF123J (+ - 5 0/0)		
4	17	PAFZZ	5905-00-795-0763	EB3915	01121	RESISTOR, FIXED, COMPOSITION	EA	1
4	19	PAFZZ	5905-00-916-3621	4702-113266	89536	RESISTOR, VARIABLE	EA	1
4	21	PAFZZ	5905-00-932-0519	4705-159475	89536	RESISTOR, FIXED, FILM 1/2 W, 8.450 OHMS (+ - 1 0/0)	EA	EA
1								
4	23	PAFZZ	5905-00-10-8348	RCR20G332JS	81349	RESISTOR, FIXED, COMPOSITION 1/2 W , 3, 300	EA	1
						OHMS (+ - 10 0/0)		
4	25	PAFZZ	5961-00-847-5247	JAN1N748A	81349	SEMICONDUCTOR DEVICE, DIODE TYPE	EA	2
						JAN1N748A		
4	21	PAFZZ	5961-00-938-1084	C6E	09214	SEMICONDUCTOR DEVICE, DIODE	EA	2
4	29	PAFZZ	5961-00-988-7397	1N3496	D3877	SEMICONDUCTOR DEVICE, DIODE TYPE 1N3496	EA	1
5	3	PAFZZ	4931-00-402-6835	1702-219196	89536	CIRCUIT CARD ASSEMBLY	EA	1
						CONSISTING OF		
5	5	PAFZZ	5910-00-990-6841	C437ARH160	73445	CAPACITOR, FIXED, ELECTROLYTIC	EA	1
5	7	PAFZZ	5910-00-797-4882	30D205G050BA4	56289	CAPACITOR, FIXED ELECTROLYTIC	EA	1
5	11	PAFZZ	5905-00-116-8568	RCR20G752JS	81349	RESISTOR, FIXED, COMPOSITION 1/2 W., 7, 500	EA	3
						OHMS, TYPE RCR20G752JS (+ - 5 0/0)		
5	13	PAFZZ	5905-00-104-8346	RCR20G334JS	81349	RESISTOR, FIXED, COMPOSITION 112 W , 330, 000	EA	1
						OHMS, TYPE RCR20G334JS (+ - 5 0/0)		
5	15	PAFZZ	5905-00-141-1168	RCR20CG222JS	81349	RESISTOR, FIXED, COMPOSITION 1/2 W , 2, 200	EA	REF
						OHMS, TYPE RCR20G222JS (+ - 5 0/0)		
5	17	PAFZZ	5905-00-171-1975	RC42GF151J	81349	RESISTOR, FIXED, COMPOSITION 2 W , 150	EA	1
						OHMS, TYPE RC42GF151J (+ - 5 0/0)		
5	19	PAFZZ	5905-00-252-1953	RC42GF1100J	81349	RESISTOR, FIXED, COMPOSITION 2 W , 10	EA	4
						OHMS, TYPE RC42GF100J (+ - 5 0/0)		
5	21	PAFZZ	5905-00-072-8125	4702-113092	89536	RESISTOR, VARIABLE	EA	1
5	23	PAFZZ	5961-00-850-9438	JAN1N3033B	81349	SEMICONDUCTOR DEVICE, DIODE TYPE	EA	1
						JAN1N3033B		
5	25	PAFZZ	5961-00-846-9157	JAN1N759A	81349	SEMICONDUCTOR DEVICE, DIODE TYPE 1N759A	EA	1
5	27	PAFZZ	5961-00-849-6875	JAN1N9748	81349	SEMICONDUCTOR DEVICE, DIODE	EA	2
5	29	PAFZZ	5961-00-925-6280	2N2869	80131	TRANSISTOR	EA	1
6	3	PAFH	4931-00-402-6829	1702-314823	89536	CIRCUIT CARD ASSEMBLY	EA	1

(1) ILLUSTRATION		(2)	(3)	(4)	(5)	(6) DESCRIPTION	(7)	(8)
(a) FIG NO.	(b) ITEM NO.	SMR CODE	NATIONAL STOCK NUMBER	PART NUMBER	FSCM	USABLE ON CODE	U/M	QTY INC IN UNIT
6	5	PAFZZ	5910-00-828-1133	C426ARE20	73445	CONSISTING OF	EA	1
6	7	PAFZZ	5953-00-850-3536	WEE2200	72259	CAPACITOR, FIXED, ELECTROLYTIC 16 V DC, 20 UF	EA	2
6	9	PAHZZ	5950-00-778-0866	WEE220	72259	COIL, RADIO FREQUENCY	EA	1
6	11	PAFZZ	5935-00-254-7101	RC42GF104J	81349	COIL, RADIO FREQUENCY	EA	1
1						RESISTOR, FIXED, COMPOSITION 2 W , 100, 000	EA	EA
6	13	PAFZZ	5905-00-104-8336	RCR20G104JS	81349	OHMS, TYPE RC42GF104J (+ - 5 0/0)	EA	REF
6	15	PAFZZ	5905-00-111-1671	RCR07G512JS	81349	RESISTOR, FIXED, COMPOSITION 1/2 W , 100, 000	EA	2
6	17	PAFZZ	5905-00-415-1592	EB1815	01121	OHMS, TYPE RCR07G512JS (+ - 5 0/0)	EA	2
6	19	PAFZZ	5905-03-415-1610	E85635	31121	RESISTOR, FIXED, COMPOSITION	EA	1
6	21	PAFZZ	5905-00-111-4735	RCR20G913JS	81349	RESISTOR, FIXED, COMPOSITION	EA	1
6	23	PAFZZ	5905-00-114- 5489	RCR20G823JS	81349	RESISTOR, FIXED, COMPOSITION 1/2 W , 91, 000	EA	1
6	25	PAFZZ	5905-00-116-8565	RCR20G623JS	81349	OHMS, TYPE RCR20G913JS (+ - 5 0/0)	EA	1
6	27	PAFZZ	5905-00-279-2527	RC42GF223J	81349	RESISTOR, FIXED, COMPOSITION 1/2 W , 82, 000	EA	1
6	29	PAFZZ	5905-00-932-0564	EB11G5	01121	OHMS, TYPE RCR20G623JS (+ - 5 0/0)	EA	7
6	30	PAHZZ		4706-155416	89536	RESISTOR, FIXED, COMPOSITION 2 W , 22, 000	EA	1
6	31	PAFZZ	5961-00-070-7481	1N4822	05277	OHMS, TYPE RC42GF223J (+ - 5 0/0)	EA	1
6	33	PAFZZ	5961-00-752-6121	1N753A	81349	RESISTOR, FIXED, FILM 1/2 W , 1/2 OHMS	EA	1
6	35	PAFZZ	5961-00-924-6981	JAN1N4245	81349	(+ - 5 0/0)	EA	1
6	37	PAFZZ	5961-00-843-9086	JAN1N3CS1R	81349	RESISTOR, WW 2KP0RM5PCT10W	EA	1
6	39	PAFZZ	5961-00-848-7007	JAN1N968B	81349	SEMICONDUCTOR DEVICE, DIODE	EA	17
6	41	PAFZZ	5961-00-089-7447	2N4299	83131	SEMICONDUCTOR DEVICE, DIODE TYPE 1N753A	EA	1
6	43	PAFZZ	5961-00-892-8706	1U212257-1	18876	SEMICONDUCTOR DEVICE, DIODE	EA	3
6	45	PAFZZ	5961-00-938-5100	10041302	18876	SEMICONDUCTOR DEVICE, DIODETYPE 1N30518	EA	8
6	47	PAFZZ	5961-00-930-5325	2N3565	49956	SEMICONDUCTOR DEVICE, DIODETYPE 1N9688	EA	1
6	49	PAFZZ	5961-00-847-6841	2N1671A	03508	SEMICONDUCTOR DEVICE, DIODETYPE 1N9688	EA	8
7	3	PAFH	4931-00-402-6828	1702-314864	89536	TRANSISTOR	EA	8
7	5	PAFZZ	5910-00-995-0614	CM05FD221G03	81349	TRANSISTOR	EA	1
7	7	PAFZZ	5962-00-563-1929	LM301A	12040	CIRCUIT CARD ASSEMBLY	EA	1
7	9	PAFZZ	6625-00-826-7062	4ST1-2	82647	CONSISTING OF	EA	1
7	11	PAFZZ	5905-00-111-8376	EB15G5	01121	CAPACITOR, FIXED, MICA DIELECTRIC 500 V	EA	1
						DC, 220 UUF, TYPE CMO5FD221G03	EA	1
						INTEGRATED CIRCUIT AMPLIFIER	EA	1
						REFERENCE OVEN	EA	1
						RESISTOR, FIXED, COMPOSITION	EA	1

(1) ILLUSTRATION		(2)	(3)	(4)	(5)	(6) DESCRIPTION	(7)	(8)
(a) FIG NO.	(b) ITEM NO.	SMR CODE	NATIONAL STOCK NUMBER	PART NUMBER	FSCM	USABLE ON CODE	U/M	QTY INC IN UNIT
7	13	PAFZZ	5905-00-478-7366	RCR42G330JS	81349	RESISTOR, FIXED, COMPOSITION 2 W.33 OHMS, TYPE RC42GF330J (+ - 5 0/0)	EA	1
7	15	PAFZZ	5961-00-932-0511	CDQ10656	07910	TRANSISTOR	EA	1
8	3	PAFH	4931-00-402-6827	1702-314872	89536	CIRCUIT CARD ASSEMBLY CONSISTING OF	EA	1
8	5	PAFZZ	5910-00-762-0941	1PC153G	2799	CAPACITOR , ELECTRICAL	EA	2
8	7	PAFZZ	5910-00-678-8157	DD101	71590	CAPACITOR, FIXED, CERAMIC DIELECTRIC	EA	1
8	9	PAFZZ	5910-00-220-3094	KC100C10K	05397	CAPACITOR, FIXED, ELECTROLYTIC	EA	1
8	11	PAFZZ	5910-00-809-8090	30D505G025BA4	56289	CAPACITOR. FIXED, ELECTROLYTIC 25 V, 5 UF (+ 75 - 10 0/0.	EA	2
8	13	PAFZZ	5910-00-914-3455	C426ARF50	73445	CAPACITOR, FIXED, ELECTROLYTIC	EA	2
8	15	PAFZZ	5910-00-920-3813	30D107G003CB4	56289	CAPACITOR, FIXED, ELECTROLYTIC	EA	2
8	17	PAFZZ	5910-00-995-0614	CM05FD221G03	81349	CAPACITOR, FIXED, MICA DIELECTRIC 500 V DC, 220 UUF, TYPE CMO5FD221G03	EA	REF
8	19	PAFZZ	5910-00-071-9922	C280AEA100K	73445	CAPACITOR, FIXED, PLASTIC	EA	1
8	21	PAFZZ	5910-00-080-5377	C280AEA47K	73445	CAPACITOR, FIXED, PLASTIC, DIELECTRIC	EA	2
8	23	PAFZZ	5905-00-959-1202	CB1045	01121	RESISTOR, FIXED, COMPOSITION	EA	3
8	25	PAFZZ	5905-00-106-1356	RCR07G152JS	81349	RESISTOR, FIXED, COMPOSITION 1/4 W, 1, 500 OHMS, TYPE RCR07G152JS (+ - 5 0/0)	EA	1
8	27	PAFZZ	5905-00-114-5344	RCR07G184JS	81349	RESISTOR, FIXED, COMPOSITION 1/4 W, 180, 000 OHMS, TYPE RCR07G184JS (+ - 5 0/0)	EA	1
8	29	PAFZZ	5905-00-119-3505	RCR07G683JS	81349	RESISTOR, FIXED, COMPOSITION 1/4 W, 68, 000 OHMS, TYPE RCR07G683JS (+ - 5 0/0)	EA	1
1								
8	31	PAFZZ	5905-00-121-9919	RCR07G106JS	81349	RESISTOR, FIXED, COMPOSITION 1/4 W, 10 MEG, TYPE RCR07G107JS (+ - 5 0/0)	EA	1
8	33	PAFZZ	5905-00-136-8430	RCR07G363JS	81349	RESISTOR, FIXED, COMPOSITION 1/4 W, .36, 000 OHMS, TYPE RCR07G363JS (+ - 5 0/0)	EA	1
1								
8	35	PAFZZ	5905-00-141-1295	RCR07G243JS	81349	RESISTOR, FIXED, COMPOSITION 1/4 W, 24, 00 OHMS, TYPE RCR07G243JS (+ - 5 0/0)	EA	1
8	37	PAFZZ	5905-00-402-4264	CB3355	01121	RESISTOR, FIXED, COMPOSITION	EA	1
8	39	PAFZZ	5905-00-904-5689	CB1535	01121	RESISTOR, FIXED, COMPOSITION	EA	1
8	41	PAFZZ	5905-00-909-3919	CB2015	01121	RESISTOR, FIXED, COMPOSITION	EA	3
8	43	PAFZZ	5905-00-909-3885	CB1035	01121	RESISTOR, FIXED, COMPOSITION	EA	1
8	45	PAFZZ	5905-00-909-3967	CB3335	01121	RESISTOR, FIXED, COMPOSITION	EA	1
8	47	PAFZZ	5905-00-911-3792	CB1335	01121	RESISTOR, FIXED, COMPOSITION	EA	1
8	49	PAFZZ	5905-00-911-3801	CB1835	01121	RESISTOR, FIXED, COMPOSITION	EA	1
8	51	PAFZZ	5905-00-911-3811	CB2235	01121	RESISTOR, FIXED, COMPOSITION	EA	5
8	53	PAFZZ	5905-00-960-0099	CB1005	01121	RESISTOR, FIXED, COMPOSITION	EA	1
8	55	PAFZZ	5905-00-960-0128	CB4735	31121	RESISTOR, FIXED, COMPOSITION	EA	1
8	57	PAFZZ	5905-00-989-1969	CB8225	01121	RESISTOR, FIXED, COMPOSITION	EA	1
8	59	PAFZZ	5905-00-105-7768	RCR07G561JS	81349	RESISTOR, FIXED, COMPOSITION 1/4 W, 560 OHMS, TYPE RCR07G561JS (+ - 5 0/0)	EA	1

(1) ILLUSTRATION		(2)	(3)	(4)	(5)	(6) DESCRIPTION	(7)	(8)
(a) FIG NO.	(b) ITEM NO.	SMR CODE	NATIONAL STOCK NUMBER	PART NUMBER	FSCM	USABLE ON CODE	U/M	QTY INC IN UNIT
						MAINFRAME ASSEMBLY CONSISTING OF		
9	3	PAFZZ	5962-00-938-9339	U5B7709393	07263	INTEGRATED CIRCUIT, LINEAR AMPLIFIER	EA	1
9	5	PAFZZ	5905-00-136-3890	RCR07G513JS	81349	RESISTOR, FIXED, COMPOSITION C85135 FSCM 01121	EA	1
9	7	PAFZZ	5905-00-484-7608	78PR5K	73138	RESISTOR, VARIABLE, NON WIRE WOUND	EA	1
9	9	PAFZZ	5961-00-194-8779	FT704	07263	TRANSISTOR	EA	1
9	11	PAFZZ	5961-00-931-0372	2N3906	80131	TRANSISTOR	EA	1
9	13	PAFZZ	5961-00-892-8706	10212257-1	18876	TRANSISTOR	EA	REF
9	15	PAFZZ	5913-00-087-9607	SCA599556	80063	CAPACITOR, FIXED, CERAMIC DIELECTRIC	EA	2
9	17	PAFZZ	5910-00-914-2353	C437ARF400	73445	CAPACITOR, FIXED, ELECTROLYTIC	EA	1
9	19	PAFZZ	5910-00-413-0338	1507-106450	89536	CAPACITOR, FIXED, PLASTIC DIELECTRIC	EA	2
9	23	PAFZZ	5355-00-240-6899	2405-158956	89536	KNOB	EA	3
9	25	PAFZZ	5355-00-498-0828	2405-158949	89536	KNOB	EA	1
9	27	PAFZZ	6240-00-950-1727	757	08806	LAMP, INCANDESCENT	EA	5
9	29	PAFZZ	5940-00-269-2219	PB01FA04	81349	POST, BINDING PLASTIC CAP, PLASTIC BASE, 0.64 DIA, 1.187 H OF POST ABOVE MTG SURFACE	EA	1
9	31	PAFZZ	5940-00-935-3404	DF31BLC	58474	POST, BINDING, ELECTRICAL	EA	1
9	33	PAFZZ	5945-00-898-1464	4504-148941	89536	RELAY, ARMATURE	EA	1
9	35	PAFZZ	5905-00-072-0654	H82221	01121	RESISTOR	EA	2
9	37	PAFZZ	5905-00-106-1273	RCR20G153JS	81349	RESISTOR, FIXED, COMPOSITION 1/2 W, 15, 000	EA	EA
2								
9	39	PAFZZ	5905-00-111-4742	RCR20G391JS	81349	OHMS, TYPE RCR20G153JS (+ - 5 0/0) RESISTOR, FIXED, COMPOSITION 1/2 W, 390	EA	2
9	41	PAFZZ	5905-00-110-0196	RCR20G102JS	81349	OHMS, TYPE RCR20G391JS (+ - 5 0/0) RESISTOR, FIXED, COMPOSITION 1/2 W, 1, 000	EA	REF
9	43	PAFZZ	5905-00-106-9344	RCR20G101JS	81349	OHMS, TYPE RCR20G102JS (+ - 5 0/0) RESISTOR, FIXED, COMPOSITION 1/2 W, 100	EA	REF
9	45	PAFZZ	5905-00-121-9861	RCR32G102JS	81349	OHMS, TYPE RCR20G101JS (+ - 5 0/0) RESISTOR, FIXED, COMPOSITION W, 1, 000	EA	1
9	47	PAFZZ	5905-00-252-1050	RCR32G393JS	81349	OHMS, TYPE RCR32G102JS (+ - 5 0/0) RESISTOR, FIXED, COMPOSITION	EA	1
9	49	PAFZZ	5905-00-247-8732	RCR32G471JS	81349	RESISTOR, FIXED, COMPOSITION W, 470 OHMS, TYPE RCR32G471JS (+ - 5 0/0)	EA	2
9	51	PAFZZ	5905-00-141-1116	RCR20G562JS	81349	RESISTOR, FIXED, COMPOSITION	EA	1
9	53	PAFZZ	5905-00-795-0771	EB1031	04061	RESISTOR 1/2 W, 10, 000 OHMS (+ - 10 0/0)	EA	2
9	55	PAFZZ	5961-00-070-7481	1N4822	05277	SEMICONDUCTOR DEVICE, DIODE	EA	48
9	57	PAFZZ	5961-00-924-6981	JAN1N4245	81349	SEMICONDUCTOR DEVICE, DIODE	EA	REF
9	59	PAFZZ	5961-00-932-0511	CDQ10656	07910	TRANSISTOR	EA	REF

**NATIONAL STOCK NUMBER AND PART NUMBER INDEX**  
**National Stock Number Cross-Referenced to Figure and Item Number**

NATIONAL STOCK NUMBER	FIG. NO.	ITEM NO.	NATIONAL STOCK NUMBER	FIG. NO.	ITEM NO.
5910-00-013-2493	2	9	5910-00-413-0338	9	19
5905-90-052-8396	2	13	5905-00-415-1568	2	21
5961-00-070-7481	6	31	5905-00-415-1576	1	7
5961-00-071-7481	9	55	5905-00-415-1592	6	17
5910-00-071-9922	8	19	5905-00-415-1610	6	19
5905-03-072-0654	9	35	5961-00-450-5101	2	51
5905-00-072-8125	5	21	5905-00-478-7366	1	13
5910-00-080-5377	8	21	5905-00-484-7608	9	7
5905-00-087-1160	3	7	5355-00-498-0828	9	25
5910-90-087-9607	9	15	5962-09-563-1929	7	7
5961-00-089-7447	6	41	5961-00-669-6884	2	49
5905-30-104-8336	2	15	5910-00-678-8157	8	7
5905-00-104-8336	6	13	5910-00-686-6428	8	3
5905-00-104-8340	2	17	5961-00-752-6121	6	33
5905-30-104-8346	5	13	5910-30-762-0941	8	5
5905-00-104-8348	3	11	5950-00-778-0866	6	9
5905-00-104-8348	4	23	5905-00-795-0763	4	17
5905-00-104-8350	2	39	5905-00-795-0771	9	53
5905-00-105-7768	8	59	5910-00-797-4882	5	7
5905-00-106-1245	2	19	5905-00-807-7506	2	11
5905-00-106-1273	9	37	5910-00-809-8090	8	11
5905-00-106-1282	3	27	6625-00-826-7062	1	9
5905-00-106-1356	8	25	5910-00-828-1133	6	5
5905-00-106-9344	3	25	5961-00-843-9086	6	37
5905-00-106-9344	9	43	5961-00-846-9157	5	25
5905-00-110-0196	3	13	5961-00-847-5247	4	25
5905-00-110-0196	9	41	5961-00-847-6841	6	49
5905-00-110-0310	2	25	5961-00-848-7007	6	39
5905-00-111-1679	6	15	5961-00-849-6875	5	27
5905-00-111-4735	6	21	5950-00-850-3536	6	7
5905-00-111-4742	9	39	5961-00-850-9438	5	23
5905-00-111-8376	7	11	5961-00-883-6064	2	41
5905-00-114-5344	8	27	5961-00-892-0734	2	45
5905-00-114-5417	3	17	5961-00-892-8706	6	43
5905-00-114-5489	6	23	5961-00-892-8106	9	13
5905-00-116-8565	6	25	5945-00-892-1464	9	33
5905-00-116-8568	5	11	5905-00-904-5689	8	39
5905-00-119-3505	8	29	5905-00-909-3885	8	43
5905-00-121-9861	9	45	5905-00-909-3919	8	41
5905-00-121-9919	8	31	5905-00-909-3967	8	45
5905-00-126-0529	3	9	5905-00-911-3792	8	47
5905-00-136-3890	9	5	5905-00-911-3801	8	49
5905-00-136-8430	8	33	5905-00-911-3810	8	51
5905-00-141-0591	3	19	5910-00-914-2353	9	17
5905-00-141-0592	3	15	5910-00-914-3455	8	13
5905-00-141-0595	4	13	5905-00-916-3627	4	19
5905-00-141-0596	2	23	5910-00-920-3813	8	15
5905-00-141-0600	2	33	5961-00-924-6981	6	35
5905-00-141-1116	4	11	5961-00-924-5981	9	57
5905-00-141-1116	9	51	5961-00-925-6280	5	29
5905-00-141-1168	3	23	5910-00-928-5631	2	5
5905-00-141-1168	5	15	5910-00-929-2621	4	5
5905-00-141-1187	2	35	5910-00-930-4850	2	7
5905-00-141-1187	2	37	5961-00-930-5325	3	35
5905-00-141-1295	8	35	5961-00-930-5325	6	47
5905-00-171-1975	5	17	5961-00-931-0372	9	11
5961-00-194-8779	9	9	5961-00-932-0511	7	15
5910-00-220-3094	8	9	5961-00-932-0511	9	59
5910-00-235-9116	3	5	5905-00-932-0519	4	21
5355-00-240-6899	9	23	5961-00-932-0553	3	29
5905-10-246-9396	3	21	5905-00-932-0564	6	29
5905-00-247-8732	9	49	5940-00-935-3404	9	31
5905-00-249-4210	4	15	5910-00-936-3577	4	9
5905-00-252-1050	9	47	5961-00-938-1084	4	27
5905-00-252-1953	5	19	5961-00-938-5100	6	45
5905-00-254-7101	6	11	5962-00-938-9339	9	3
5985-00-256-0412	2	27	5961-00-943-9407	3	33
5940-00-269-2219	9	29	6240-00-950-1727	9	27
5905-00-279-2527	6	27	5905-00-959-1202	8	23
5905-00-279-3527	2	29	5905-30-960-0099	8	53
5905-00-402-4264	8	37	5905-00-960-0126	8	55
4931-00-402-6827	8	3	5910-00-965-9728	1	5
4931-00-402-6828	7	3	5961-00-971-1707	2	41
4931-00-402-6829	6	3	5961-00-986-3161	2	43
4931-00-402-6834	1	3	5910-00-988-4809	2	5
4931-00-402-6835	5	3	5961-00-988-7397	4	29
4931-00-402-6836	4	3	5905-00-989-1969	8	57
4931-00-402-6837	3	3	5910-00-990-6841	5	5
4931-00-402-6847	2	3	5910-00-994-6910	4	7
5961-00-413-0304	3	31	5910-00-995-0614	7	5

**NATIONAL STOCK NUMBER AND PART NUMBER INDEX**  
**National Stock Number Cross-Referenced to Figure and Item Number**

NATIONAL STOCK NUMBER	FIG. NO.	ITEM NO.	NATIONAL STOCK NUMBER	FIG. NO.	ITEM NO.		
PART NUMBER	a	17					
	FSCM	FIG. NO.	ITEM NO.	PART NUMBER	FSCM	FIG. NO.	ITEM NO.
CB1005	01121	8	53	RCR20G103JS	81349	3	19
CB1035	01121	8	43	RCR20G104JS	81349	2	15
CB1045	01121	8	23	RCR20G104JS	81349	6	13
CB1335	01121	8	47	RCR20G122JS	81349	3	15
CB1535	01121	8	39	RCR20G153JS	81349	9	37
CB1835	01121	8	49	RCR20G203JS	81349	2	35
CB2015	01121	8	41	RCR20G203JS	81349	2	37
CB2235	11121	8	51	RCR20G221JS	81349	2	39
CB3335	01121	8	45	RCR20G222JS	81349	3	23
CB335	01121	8	37	RCR20G222JS	81349	5	15
CB4735	01121	8	55	RCR20G223JS	81349	3	27
CB8225	01121	8	57	RCR20G226JS	81349	3	21
CDQ10656	07910	7	15	RCR20G302JS	81349	3	17
CDQ10656	07910	9	59	RCR20G332JS	81349	3	11
CD13161	07910	2	41	RCR20G332JS	81349	4	23
CM05FD221G03	81349	7	5	RCR20G334JS	81349	5	13
CM05FD221G03	81349	8	17	RCR20G363JS	81349	2	17
C280AEA100K	73445	8	19	RCR20G391JS	81349	9	39
C280AEA47K	73445	8	21	RCR20G392JS	81349	2	25
C280AEP470K	73445	2	9	RCR20G472JS	81349	4	13
C426ARE20	73445	6	5	RCR20G473JS	81349	2	23
C426ARF50	73445	8	13	RCR20G562JS	81349	4	11
C437ARF400	73445	9	17	RCR20G562JS	81349	9	51
C437ARG250	73445	3	5	RCR20G623JS	81349	6	25
C437ARH160	73445	5	5	RCR20G752JS	81349	5	11
C437ARH250	73445	4	7	RCR20G822JS	81349	2	33
C6E	09214	4	27	RCR20G823JS	81349	6	23
DD101	71590	8	7	RCR20G913JS	81349	6	21
DF31BLC	58474	9	31	RCR32G102JS	81349	9	45
EB1031	04061	9	53	RCR32G272JS	81349	2	19
EB11G5	01121	6	29	RCR32G393JS	81349	9	47
EB15G5	01121	7	11	RCR32G471JS	81349	9	49
EB1815	01121	6	IT	RCR42G330JS	81349	7	13
EB2025	01121	2	21	RC42GF100J	81349	5	19
EB2425	01121	2	13	RC42GF104J	81349	6	11
EB2735	01121	1	7	RC42GF123J	81349	4	15
EB3915	01121	4	17	RC42GF151J	81349	5	17
EB5115	01121	3	7	RC42GF181J	81349	2	27
EB5635	91121	6	19	RC42GF223J	81349	6	27
FB6215	01121	2	11	RC42GF470J	81349	2	29
EB6225	31121	3	9	SCA599556	83063	9	15
FT704	07263	9	9	U1249	15818	3	29
HB2221	01121	9	35	U5B7709393	17263	9	3
JAN1N277	81349	2	49	WEE220	72259	6	9
JAN1N3033B	81349	5	23	WEE2200	72259	6	7
JAN1N3051B	81349	6	37	1N3496	03877	4	29
JAN1N4245	81349	6	35	1N4822	05277	6	31
JAN1N4245	81349	9	57	1N4822	95277	9	55
JAN1N483B	81349	2	45	1N753A	81349	6	33
JAN1N748A	81349	4	25	1N961A	07910	2	43
JAN1N749A	81349	2	47	1PC153G	32799	8	5
JAN1N759A	81349	5	25	10041302	18876	6	45
JAN1N968B	81349	6	39	10212257-1	18876	6	43
JAN1N974B	81349	5	27	10212257-1	18876	9	13
JAN2N3250A	81349	3	33	1507-106450	89536	9	19
K100C1DK	05397	8	9	1702-219154	89536	2	3
K15C20K	05397	2	5	1702-219162	89536	3	3
K2R2C20K	05397	2	7	1702-219188	89536	4	3
K68C15K	05397	4	5	1702-219196	89536	5	3
LM301A	12040	7	7	1702-314815	89536	1	3
PB01FA04	81349	9	29	1702-314823	89536	6	3
RCR07G106JS	81349	8	31	1712-314864	89536	7	3
RCR07G152JS	81349	8	25	1702-314872	89536	8	3
RCR07G184JS	81349	a	27	192P10252	56289	1	5
RCR07G243JS	81349	8	35	192P12292	56289	4	9
RCR07G363JS	81349	8	33	2N1671A	03508	6	49
RCR07G512JS	81349	6	15	2N2869	83131	5	29
RCR07G513JS	81349	9	5	2N3565	49956	3	35
RCR07G561JS	81349	8	59	2N3565	49956	6	47
RCR07G683JS	81349	8	29	2N3906	83131	9	11
RCR20G101JS	81349	3	25	2N4299	8D131	6	41
RCR20G101JS	81349	9	43	2405-158949	89536	9	25
RCR20G102JS	81349	3	13	2405-158956	89536	9	23
RCR20G102JS	81349	9	41	29C300	56289		5

**NATIONAL STOCK NUMBER AND PART NUMBER INDEX**  
**National Stock Number Cross-Referenced to Figure and Item Number**

<b>PART NUMBER</b>	<b>FSCM</b>	<b>FIG. NO.</b>	<b>ITEM NO.</b>	<b>PART NUMBER</b>	<b>FSCM</b>	<b>FIG. NO.</b>	<b>ITEM NO.</b>
30D107G003CB4	56289	8	15	4705-159475	89536	4	21
30C205G050BA4	56289	5	7	4706-155416	89536	6	30
30D505G025BA4	56289	8	11	4805-159491	89536	2	51
4ST1-2	82647	7	9	4805-168716	89536	3	31
4504-148940	89536	9	33	757	08806	9	21
4702-113092	89536	5	21	78PR5K	73138	9	7
4702-113266	89536	4	19	913-3533-00	13499		3

**Change 2 74**



STOCK NUMBER	FIG.	ITEM	STOCK NUMBER	FIG.	ITEM
5961-943-9407	3	33	5962-563-1929	7	7
5961-971-1707	2	41	5962-938-9339	9	3
5961-986-3161	2	43	6240-950-1727	9	27
5961-988-7397	4	29	6625-826-7062	7	9

REFERENCE NO.	MFR CODE	FIG. NO.	ITEM NO.	REFERENCE NO.	MFR CODE	FIG. NO.	ITEM NO.
CB1005	01121	8	53	RCR07G106JS	81349	8	31
CB1035	01121	8	43	RCR07G152JS	81349	8	25
CB1045	01121	8	23	RCR07G184JS	81349	8	27
CB1335	01121	8	47	RCR07G243JS	81349	8	35
CB1535	01121	8	39	RCR07G363JS	81349	8	33
CB1835	01121	8	49	RCR07G512JS	81349	6	15
CB2235	01121	8	51	RCR07G561JS	81349	8	59
CB3335	01121	8	45	RCR07G683JS	81349	8	29
CB3355	01121	8	37	RCR20G101JS	81349	3	25
CB4735	01121	8	55	RCR20G101JS	81349	9	43
CB5135	01121	9	5	RCR20G102JS	81349	3	13
CB8225	01121	8	57	RCR20G102JS	81349	9	41
CC325230	11870		3	RCR20G103JS	81349	3	19
CDQ10656	07910	7	15	RCR20G104JS	81349	2	15
CDQ10656	07910	9	59	RCR20G104JS	81349	6	13
CD13161	07910	2	41	RCR20G122JS	81349	3	15
CM05FD221G03	81349	7	5	RCR20G153JS	81349	9	37
CN05FD221G03	81349	8	17	RCR20G203JS	81349	2	37
CR2015	01121	8	41	RCR20G221JS	81349	2	39
C280AEA100K	73445	8	19	RCR20G222JS	81349	3	23
C280AEA47K	73445	8	21	RCR20G222JS	81349	5	15
C280AEP470K	73445	2	9	RCR20G223JS	81349	3	27
C426ARE20	73445	6	5	RCR20G226JS	81349	3	21
C426ARF50	73445	8	13	RCR20G302JS	81349	3	17
C437ARF400	73445	9	17	RCR20G332JS	81349	3	11
C437ARG250	73445	3	5	RCR20G334JS	81349	5	13
C437ARH160	73445	5	5	RCR20G363JS	81349	2	17
C437ARH250	73445	4	7	RCR20G391JS	81349	9	39
C6E	03508	4	27	RCR20G392JS	81349	2	25
DD101	71590	8	7	RCR20G472JS	81349	4	13
DF31BLC	58474	9	31	RCR20G473JS	81349	2	23
EB1031	01121	9	53	RCR20G623JS	81349	6	25
EB11G5	01121	6	29	RCR20G752JS	81349	5	11
EB15G5	01121	7	11	RCR20G822JS	81349	2	33
EB1635	01121	2	31	RCR20G823JS	81349	6	23
EB1815	01121	6	17	RCR20G913JS	81349	6	21
EB2025	01121	2	21	RCR32G102JS	81349	9	45
EB2035	01121	2	35	RCR32G272JS	81349	2	19
EB2425	01121	2	13	RCR32G393JS	81349	9	47
EB2735	01121	1	7	RCR32G471JS	81349	9	49
EB3321	01121	4	23	RC42GF100J	81349	5	19
EB3915	01121	4	17	RC42GF104J	81349	6	11
EB5115	01121	3	7	RC42GF123J	81349	4	15
EB5621	01121	9	51	RC42GF151J	81349	5	17
EB5625	01121	4	11	RC42GF181J	81349	2	27
EB5635	01121	6	19	RC42GF223J	81349	6	27
EB6215	01121	2	11	RC42GF330J	81349	7	13
EB6225	01121	3	9	RC42GF470J	81349	2	29
FHN20G	81349	9	21	SCA599556	80063	9	15
FT704	07263	9	9	U1249	15818	3	29
HB1211	01121	5	9	WEE220	72559	6	9
HB2221	01121	9	35	WEE2200	72559	6	7
JAN1N277	81349	2	49	07263	07269	9	3
JAN1N3033B	81349	5	23	1N3496	03877	4	29
JAN1N3051B	81349	6	37	1N4822	05277	6	31
JAN1N4245	81349	6	35	1N4822	05277	9	55
JAN1N4245	81349	9	57	1N759A	81349	5	25
JAN1N483B	81349	2	45	1N961A	07910	2	43
JAN1N748A	81350	4	25	1PC1536	02799	8	5
JAN1N749A	81349	2	47	10041302	18876	6	45
JAN1N753A	81349	6	33	10212257-1	18876	6	43
JAN1N968B	81349	6	39	10212257-1	18876	9	13
JAN1N9774B	81349	5	27	1507-106450	89536	9	19
J2N3250A	81349	3	33	1702-219154	89536	2	3
K100C10K	05397	8	9	1702-219162	89536	3	3
K15C20K	05397	2	5	1702-219188	89536	4	3
K2R2C20K	05397	2	7	1702-219196	89536	5	3
K68C15K	05397	4	5	1702-314815	89536	1	3
LM301A	12040	7	7	1702-314823	89536	6	3
PB01FA04	81349	9	29	1702-314864	89536	7	3

REFERENCE NO.	MFR CODE	FIG. NO.	ITEM NO.	REFERENCE NO.	MFR CODE	FIG. NO.	ITEM NO.
1702-314872	89536	8	3	30D107G003CB4	56289	8	15
192P10252	56289	1	5	30D205G050BA4	56289	5	7
192P12292	56289	4	9	30D505G025BA4	56289	8	11
2N1671A	03508	6	49	4ST1-2	01294	7	9
2N2869	80131	5	29	4504-148940	89536	9	33
2N3565	81349	3	35	4702-113092	89536	5	21
2N3565	81349	6	47	4702-113266	89536	4	19
2N3906	80131	9	11	4705-159475	84536	4	21
2N4299	49671	6	41	4805-159491	89536	2	51
2405-158949	89536	9	25	4805-198812	89536	3	31
2405-158956	89536	9	23	757	89730	9	27
29C300	56289		5	78PR5K	73138	9	7

Change 1, 76

*By Order of the Secretary of the Army:*

*FRED C. WEYAND  
General, United States Army,  
Chief of Staff.*

Official:

*VERNE L. BOWERS  
Major General, United States Army,  
The Adjutant General.*

Distribution:

To be distributed in accordance with DA Form 12-34, Section II, (qty rqr block No. 75) requirements for Calibration Procedures Publications.

**Change 1**

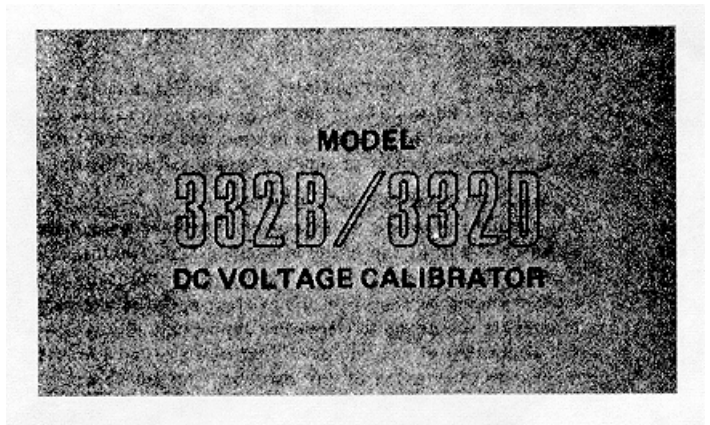

Rev. 1 8/18/71

SEPTEMBER 1969

## Table of Contents

SECTION	TITLE	PAGE
0.	<b>GENERAL</b> .....	0-1
1.	<b>INTRODUCTION AND SPECIFICATIONS</b> .....	1-1
	1-1. Introduction .....	1-1
	1-6. Electrical Specifications .....	1-1
	1-7. Environmental Specifications.....	1-2
	1-8. Mechanical Specifications.....	1-2
	1-9. General Specifications .....	1-3
	1-10. References.....	1-4
2.	<b>OPERATING INSTRUCTIONS</b> .....	2-1
	2-1. Introduction .....	2-1
	2-4. Controls, Terminals and Indicators .....	2-1
	2-6. Input Power.....	2-1
	2-8. Preliminary Operation .....	2-1
	2-9. General .....	2-1
	2-11. Voltage Trip Setting .....	2-1
	2-13. Current Limit Setting .....	2-4
	2-15. Sense Connections.....	2-4
	2-18. Guard Connection.....	2-5
	2-20. Operation .....	2-6
	2-22. Applications.....	2-6
	2-24. Operation as a 10 PPM Calibrator .....	2-7
	2-26. Operation as a 20 PPM Differential Voltmeter .....	2-7
	2-28. Standard Cell Comparison.....	2-7
3.	<b>THEORY OF OPERATION</b> .....	3-1
	3-1. Introduction .....	3-1
	3-3. Functional Description .....	3-1
	3-7. Circuit Descriptions .....	3-2
	3-8. Voltage Control Circuitry .....	3-2
	3-23. Pre-Regulation Circuitry .....	3-4
	3-28. Protection Circuitry.....	3-4
	3-34. Miscellaneous Circuitry .....	3-5

*(Continued on page ii)*

## TABLE OF CONTENTS, continued

SECTION	TITLE	PAGE
<b>4.</b>	<b>MAINTENANCE .....</b>	<b>4-1</b>
	4-1. Introduction .....	4-1
	4-3. Service Information .....	4-1
	4-6. General Maintenance.....	4-1
	4-7. Maintenance Access.....	4-1
	4-10. Unique Maintenance Procedures.....	4-1
	4-14. Fuse Replacement.....	4-2
	4-16. Lamp Replacement.....	4-2
	4-18. 115/230V Conversion .....	4-2
	4-20. Performance Tests .....	4-2
	4-21. Introduction .....	4-2
	4-27. DC Output.....	4-4
	4-32. Meter and Protection Circuits.....	4-6
	4-36. Calibration.....	4-7
	4-37. Introduction .....	4-7
	4-39. Meter.....	4-7
	4-41. Auxiliary Power Supply, Monitor Circuits and Master Reference .....	4-7
	4-48. Voltage Standard Output .....	4-10
	4-54. Troubleshooting .....	4-14
	4-57. Resistance Measurements .....	4-14
	4-59. Standby Power.....	4-15
	4-61. Auxiliary Supply Voltages.....	4-15
	4-63. Unijunction Oscillator and Control Amplifier.....	4-15
	4-65. Pre-Regulator.....	4-16
	4-67. Series Pass Element.....	4-17
	4-68. Preventive Maintenance Instructions.....	4-18
<b>5.</b>	<b>LIST OF REPLACEABLE PARTS.....</b>	<b>5-1</b>
	5-1. Introduction .....	5-1
	5-3. Columnar Information .....	5-1
	5-4. How to Obtain Parts.....	5-2
	5-7. Serial Number Effectivity.....	5-2

**APPENDIX A - FEDERAL SUPPLY CODE FOR MANUFACTURERS****APPENDIX B - LIST OF ABBREVIATIONM****APPENDIX C - MAINTENANC E ALLOCATION****APPENDIX D - BASIC ISSUE ITEMS LIST  
SCHEMATIC DIAGRAMS**

---

**List of Illustrations**

---

<b>FIGURE</b>	<b>TITLE</b>	<b>PAGE</b>
Frontispiece	Model 332B DC Voltage Standard .....	vi
1-1	Model 332B Outline Drawing.....	1-3
2-1.	Controls, Terminals, and Indicators (Sheet 1 of 2).....	2-2
2-1.	Controls, Terminals, and Indicators (Sheet 2 of 2).....	2-3
2-2.	Nomograph of Voltage Drop Across Load Wires .....	2-5
2-3.	Guard Connection .....	2-6
2-4.	Operation as 10 PPM Calibrator .....	2-8
2-5.	Operation as 20 PPM Differential Voltmeter .....	2-9
3-1.	Voltage Control Circuitry.....	3-2
4-1.	115/230VAC Conversion.....	4-3
4-2.	Test and Calibration Equipment Required (Sheet 1 of 2) .....	4-3
4-2.	Test and Calibration Equipment Required (Sheet 2 of 2) .....	4-4
4-3.	Control Settings, Load Requirements, and Limits for Line Regulation .....	4-5
4-4.	Control Settings, Load Requirements, and Limits for Load Regulation .....	4-5
4-5.	Control Settings for V-I Monitor Test.....	4-6
4-6.	Control Settings for Voltage Trip Check.....	4-7

*(Continued on page iv)*

## LIST OF ILLUSTRATIONS (continued)

FIGURE	TITLE	PAGE
4-7.	Location of Adjustments .....	4-8
4-8.	Control Settings for Voltage Monitor Linearity Check.....	4-9
4-9.	Control Settings for Trip Range Check .....	4-9
4-10.	Connections for Linearization Adjustment.....	4-11
4-11.	Deck B Adjustment Instructions .....	4-12
4-12.	Deck A Adjustment Instructions .....	4-12
4-13.	Connections for Range Calibration .....	4-13
4-14.	Control Settings and Tolerances for Range Calibration.....	4-15
4-15.	Reference and Auxiliary Voltages .....	4-16
4-16.	Pre-Regulator Q1, Waveform on Stdbby/Reset .....	4-17
4-17.	Pre-Regulator Q1, Waveform on Opr .....	4-17
5-1.	DC Voltage Standard (Sheet 1 of 3).....	5-8
5-1.	DC Voltage Standard (Sheet 2 of 3).....	5-9
5-1.	DC Voltage Standard (Sheet 3 of 3).....	5-10

*(Continued on page v)*



## LIST OF ILLUSTRATIONS (continued)

FIGURE	TITLE	PAGE
5-2.	Capacitor P/C Assembly .....	5-11
5-3.	Sample String P/C Assembly .....	5-14
5-4.	Capacitor Switch P/C Assembly.....	5-16
5-5.	Reference Calibration P/C Assembly.....	5-17
5-6.	Main Mother Board P/C Assembly .....	5-19
5-7.	Master Voltage Reference P/C Assembly.....	5-20
5-8.	Seri Pass Driver P/C Assembly.....	5-24
5-9.	Differential Amplifier P/C Assembly .....	5-28
5-10.	Chopper Amplifier P/C Assembly.....	5-32
5-11.	Auxiliary Power Supply P/C Assembly.....	5-36
5-12.	Current Limiter P/C Assembly.....	5-39
5-13.	Time Delay P/C Assembly.....	5-40
5-14.	High Voltage Mother Board P/C Assembly .....	5-42
5-15.	Series Pus Element P/C Assembly .....	5-48
5-16.	Preregulator P/C Assembly.....	5-51

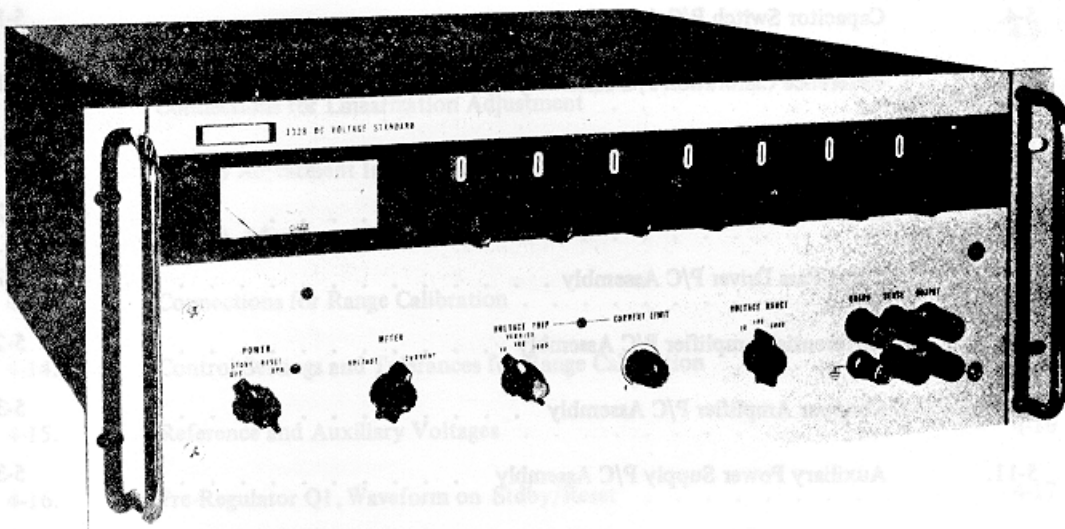

**MODEL 332B/332D DC VOLTAGE STANDARD**

## SECTION 0

### GENERAL

#### **0-1. Scope**

**0-2.** This manual includes installation and operation instructions and covers organizational, direct support (DS), and general support (GS) maintenance. It describes the Time-Mark Generator, Tektronix Types 184, and 184 MOD 146B.

**0-3.** The basic issue items list appears in Appendix D. Appendix D is current as of 18 November 1971.

#### **0-4. Index of Publications.**

**0-5.** *DA Pam 310-4.* Refer to the latest issue of DA Pam 310-4 to determine if there are any new editions, changes, or additional publications pertaining to the equipment.

**0-6.** *DA Pam 310-7.* Refer to DA Pam 310-7 to determine whether there are Modification Work Orders (MWO's) pertaining to the equipment.

#### **0-7. Forms and Records**

**0-8.** *Reports of Maintenance and Unsatisfactory Equipment.* Use equipment forms and records in accordance with instructions given in TM 38-750.

**0-9.** *Report of Packaging and Handling Deficiencies.* Fill out and forward DD Form 6 as prescribed in AR 700-58 (Army), NAVSUP Pub 378 (Navy), AFR 71-4 (Air Force), and MCO P4030.29 (Marine Corps).

**0-10.** *Discrepancy in Shipment Report.* Fill out and forward Discrepancy in Shipment Report (DISREP) (SF 361) as prescribed in AR 55-38 (Army), NAVSUP Pub 459 (Navy), AFM 75-34 (Air Force), and MCO P4610.19 (Marine Corps).

**0-11.** *Reporting of Errors.*

**0-12.** The reporting of errors, omissions, and recommendations for improving this manual is encouraged. Reports should be submitted on DA Form 2028, Recommended Changes to Publications, and forward direct to: Commanding General, U. S. Army Missile Command, ATTN: AMSMI-MFM, Redstone Arsenal, AL 35809.

## Section 1

## Introduction &amp; Specifications

**1-1. INTRODUCTION**

1-2. The Model 332B/332D DC Voltage Standard provides dc voltages from 0 to 1111 volts with an accuracy of  $\pm 0.0020\%$ . Output current is rated at 0 to 50 milliamperes; The output voltage is set by seven in-line decade switches. Separate terminals are provided for sensing the output voltage directly at the load, eliminating errors due to voltage drop in connecting wires between the instrument and load.

1-3. Protection against possible equipment failures or operator errors, which might damage expensive instruments, are incorporated. The VOLTAGE TRIP and VERNIER controls provide a means of limiting the output voltage within the selected range. Should the output voltage exceed a preset limit, the OUTPUT terminals are de-energized. A current limiting circuit limits the available current to a level determined by the setting of the CURRENT LIMIT control.

1-4. The inner chassis and circuitry are surrounded by an isolation guard, which is also isolated from the front panel and the outside cover. When properly connected, the guard bypasses any circulating ground currents which may cause error.

1-5. Most of the instrument circuitry is mounted on modular plug-in cards. An extender card is provided as an accessory to aid in the maintenance and adjustment of the instrument.

**1-6. ELECTRICAL SPECIFICATIONS****OUTPUT VOLTAGE**

0 to 1111.1110 volts dc

Rev. 1

**VOLTAGE RANGES**

Range (volts)	Output (volts)
10	0 to 11.111110 (1 uv steps)
100	0 to 111.11110 (10 uv steps)
1000	0 to 1111.110 (100 uv steps)

**RESOLUTION**

0.1 ppm of range (1 uv maximum)

**ACCURACY OF OUTPUT**

The following accuracies are absolute, relative to NBS standards, and include effects of stability, line regulation, load regulation, and calibration uncertainties under standard reference conditions of 23°C  $\pm 1^\circ\text{C}$  and up to 70% relative humidity.

Range (volts)	332B (90 Days)	Accuracy	332D (60 Days)
10	$\pm(0.002\% \text{ of setting} + 10\text{uv})$		$\pm(0.001\% \text{ of setting} + 10\text{uv})$
100	$\pm(0.002\% \text{ of setting} + 0.00002\% \text{ of range})$		$\pm(0.001\% \text{ of setting} + 0.00002\% \text{ of range})$
1000	$\pm(0.002\% \text{ of setting} + 0.00002\% \text{ of range})$		$\pm(0.0015\% \text{ of setting} + 0.00002\% \text{ of range})$

**TEMPERATURE COEFFICIENT OF OUTPUT**

Less than (0.0002% of setting + 1 uv) per °C from 0 to +50 °C.

**STABILITY OF OUTPUT**

Range (volts)	332B		332D
	Month	Year	Month
10	$\pm(0.001\%$ of setting + 10 uv)	$\pm(0.002\%$ of setting + 20 uv)	$\pm(5$ ppm of setting + 7 uv)
100	$\pm(0.001\%$ of setting + 20 uv)	$\pm(0.002\%$ of setting + 40 uv)	$\pm(5$ ppm of setting + 30 uv)
1000	$\pm(0.001\%$ of setting + 20 uv)	$\pm(0.002\%$ of setting + 40 uv)	$\pm(5$ ppm of setting +30 uv)

**OUTPUT CURRENT**

0 to 50 milliamperes at any output voltage.

**OVERCURRENT PROTECTION**

Continuously variable front-panel control. Automatically limits output current at any present level between one and 60 milliamperes. Panel lamp illuminates during limiting. Normal operation restored upon removal of overload.

**OVERVOLTAGE PROTECTION**

Front-panel control continuously variable from 1v to 1200v. Automatically disables output voltage if level exceeds selected value. Manual reset.

**RIPPLE AND NOISE**

Range (volts)	Ripple and Noise (uv rms)
10	20
100	30
1000	40

**OUTPUT RESISTANCE**

Less than 0.0005 ohms or (0.0001Eo) ohms, whichever is greater, at dc.

**SETTLING TIME**

Within 10 ppm of final output, less than 20 seconds after a range change.

**LINE REGULATION**

0.0002% of setting or 10 uv for a 10% line voltage change from nominal.

**LOAD REGULATION**

0.0002% of setting or 10 uv for full. load change.

**COMMON MODE REJECTION**

Better than 140 db from dc to 400 Hz up to 700 volts rms or 1000 volts dc. (Output voltage changes less than 10-7 of the applied common mode voltage.) ISOLATION Either output terminal may be floated up to 1000 volts dc from chassis.

**REMOTE SENSE**

Separate terminals are provided for sensing the output voltage directly at the load, thus reducing errors due to voltage drop in the output leads between the instrument and the load.

**METER**

(switch selectable) 0-1200 vdc  
0-60 ma

**1-7. ENVIRONMENTAL SPECIFICATIONS****OPERATING TEMPERATURE RANGE**

0°C to 50°C.

**RELATIVE HUMIDITY**

0 to 70%

**STORAGE TEMPERATURE RANGE**

-40°C to +65°C.

**ALTITUDE**

10, 000 feet operating; 50, 000 feet non-operating.

**SHOCK**

Meets all test requirements of MIL-T-945A, rigidly mounted or rack mounted with slides.

**1-8. MECHANICAL SPECIFICATIONS****MOUNTING**

Standard EIA relay rack (tapped for attachment of slides), resilient feet provided for bench use.

Rev. 1

**1-9. GENERAL SPECIFICATIONS**

**DESIGN**

Solid-state throughout.

**SIZE**

7 inches high by 19 inches wide by 18% inches behind panel

**WEIGHT**

60 pounds.

**INPUT POWER**

115/230 volts ac 10%, 50-60 Hz, single phase. Approximately 130 va under full load.

**FUSES**

One power line and one high voltage fuse.

**FUNGUS NUTRIENTS**

None.

**MERCURIC COMPONENTS**

None.

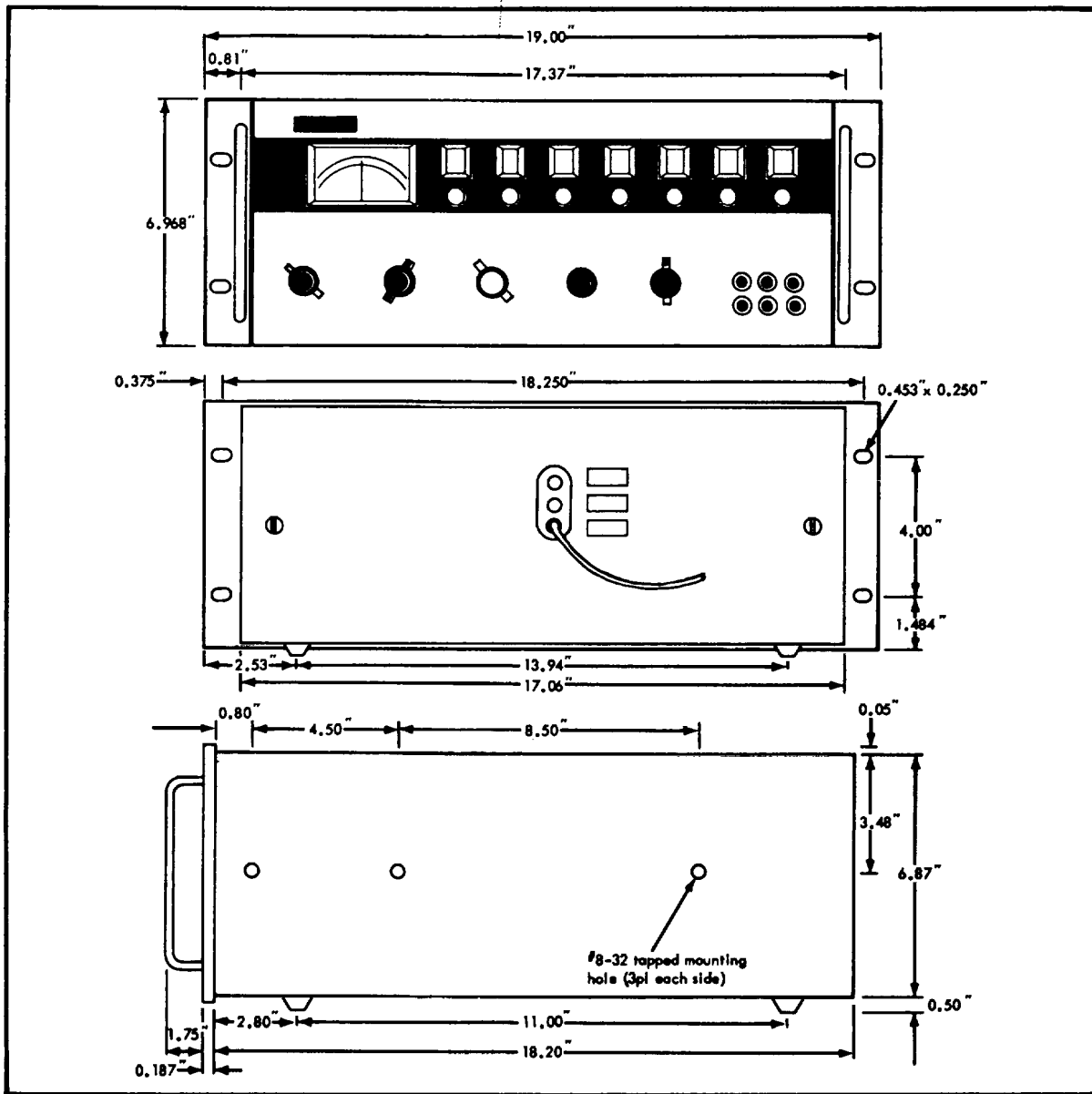

Figure 1-1. MODEL 332B/332D OUTLINE DRAWING

## **1-10. REFERENCES**

AR 700-58	Report of Packaging and Handling Deficiencies
DA Pam 310-4	Index of Technical Manuals, Technical Bulletins Supply Manuals (types 7, 8, and 9), Supply Bulletins and Lubrication Orders.
DA Pam 310-7	U.S. Army Equipment Index of Modification Work Orders.
TM 38-750	The Army Maintenance Management System (TAMMS).
SB 38-100	Preservation, Packaging, Packing, and Marking Materials, Supplies, and Equipment used by the Army.
TB 746-10	Field Instruction for Painting and Preserving Electronic Equipment.
TB 750-236	Calibration Requirements for the Maintenance of Army Materiel.

## 2-1. INTRODUCTION

2-2. This section provides instructions for operating the Model 332B and 332D. Before operating the instrument for the first time, please read paragraph 14, CONTROL, TERMINALS, AND INDICATORS, and the information contained in Figure 2-1. Before using the instrument, a few optional control adjustments and terminal connections, which enhance the instrument's performance and provide safety to external equipment, should be considered. These adjustments and connections are described in paragraph 2-8, PRELIMINARY OPERATION. Instructions for operating the instrument as a voltage standard are given in paragraph 2-20. Additional applications in combination with other instruments are given in paragraph 2-22.

2-3. If you encounter any problem in operation of your instrument, please contact your nearest John Fluke sales representative or write directly to the John Fluke Mfg. Co., with a statement of the problem. Please include the serial number of the instrument in such correspondence.

## 2-4. CONTROLS, TERMINALS AND INDICATORS

2-5. The name and function of the front and rear panel controls, terminals, and indicators are illustrated and described in Figure 2-1. The numbers at the tails of the arrow callouts correspond to the reference numbers in the chart immediately following the photographs.

## 2-6. INPUT POWER

2-7. The power transformer has dual primary windings.

Normally, these primary windings are connected in parallel for 115 volt operation. Upon request, the primary windings are connected in series at the factory for 230 volt operation. Should it become desirable to convert the instrument from one type of power line operation to the other, refer to paragraph 4-18.

## 2-8. PRELIMINARY OPERATION

### 2-9. General

2-10. Before operating the instrument, some preliminary settings and connections should be considered. Whether you use these settings and connections, or not, depends upon the degree of equipment safety and accuracy required. The following five paragraphs discuss the merits and procedures for each of the settings and connections.

### 2-11. Voltage Trip Setting

2-12. The VOLTAGE TRIP switch and VERNIER control provide protection to external equipment by limiting the maximum allowable output voltage to the external load. The range of voltage limiting is selected with the VOLTAGE TRIP switch. Refinement of the value of the voltage to be limited is accomplished with the VERNIER control. If no degree of limiting is required within the ranges of the instrument, set the VOLTAGE TRIP switch



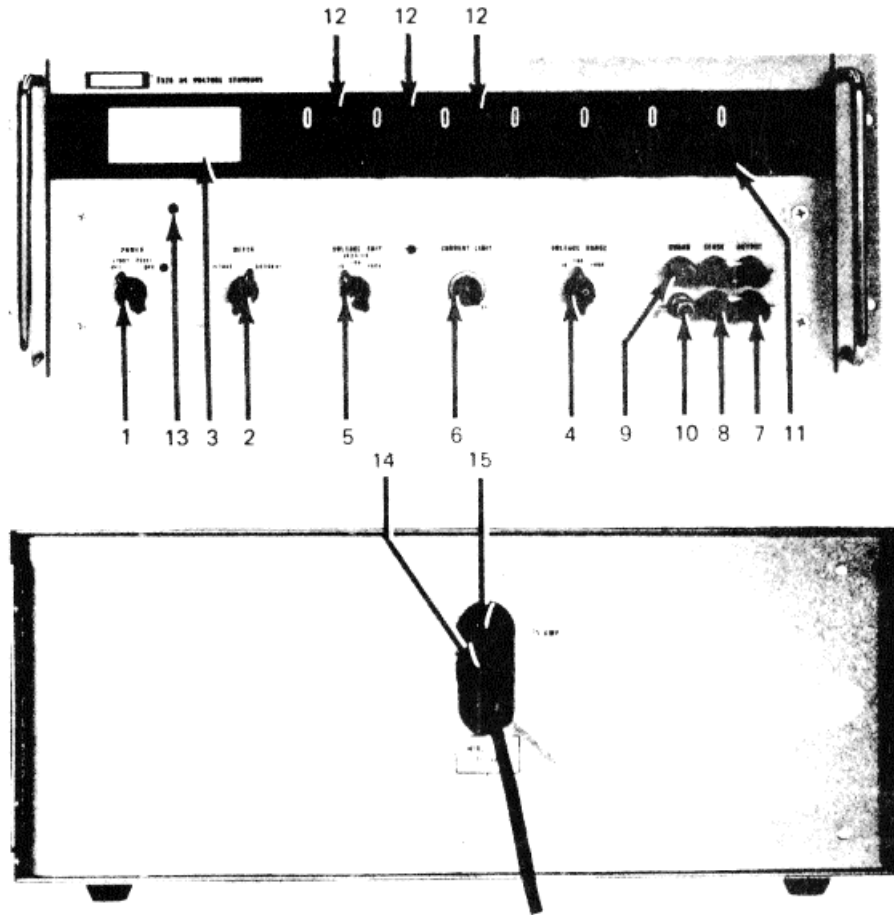

REF. NO.	NAME	FUNCTION
1	POWER switch	Applies line power to the auxiliary power supplies within the Instrument, when in the STDBY/RESET position. The instrument is completely energized when the POWER switch is in the OPR position and the red indicator lamp near the switch is illuminated.
2	METER Switch"	Selects meter indication of either output voltage or output current
3	Meter	Indicates either output voltage or output current depending on the position of the METER switch. The meter voltage range depends on the setting of the VOLTAGE RANGE switch. The current range is 0 to 60 milliamperes.
4	VOLTAGE RANGE Switch	Selects the output voltage range of 10, 100, or 1000 volts, and changes the meter to a corresponding range.

Figure 2-1. CONTROLS, TERMINALS, AND INDICATORS (Sheet 1 of 2)

REF. NO.	NAME	FUNCTION
5	VOLTAGE TRIP Switch and VERNIER Control	The VOLTAGE TRIP switch provides a means of limiting the output voltage in three ranges (10, 100, and 1000 volts) independent of the VOLTAGE RANGE switch. The VERNIER control varies the amount of limiting within the ranges of the VOLTAGE TRIP switch. When an over-voltage condition exists, the red indicator lamp near the VOLTAGE TRIP switch will illuminate and the red lamp near the POWER switch will be extinguished.
6	CURRENT LIMIT control	Provides a means of setting a limit on the magnitude of the output current within a range to 0 to 60 milliamperes. An over-current condition is signified when the indicator lamp, near the CURRENT LIMIT control, illuminates.
7	OUTPUT Terminals	Provides a convenient means of connecting the load to the output circuit.
8	SENSE Terminals	Allows the regulating circuitry to be connected to the OUTPUT terminals (7) or directly to the load for optimum regulation.
9	GUARD Terminal	When properly connected, provides a means of eliminating circulating ground currents through the load.
10	Power line ground.	
11	Readout Dials	Select and indicate the output voltage. The recessed numbers directly above each dial provide in-line readout of the output voltage. When a dial is set to "X" (10), it represents 0 with a 1 carry-over to the digit to the immediate left. For example: 10. X X X X X represents 11.111110 volts.
12	Decimal Lamps	These lamps indicate the proper decimal point setting when illuminated and are controlled by the RANGE switch.
13	Mechanical Zero adjust	Provides a means of setting the meter mechanical zero. Adjustment should be made after the instrument has been completely de-energized for at least 3 minutes.
14	Fuse, line	A 3 ampere slow-blow fuse for 115 volt power line operation. Use a 1 1/2 ampere slow-blow fuse for Instruments converted to 230 volt power line operation.
15	Fuse, high voltage	A 1/4 ampere slow-blow fuse electrically located at the output of the high voltage rectifier circuit.

Figure 2-1. CONTROLS, TERMINALS, AND INDICATORS (Sheet 2 of 2)

to 1000 and the VERNIER fully clockwise. Should some degree of limiting be desirable, proceed as follows:

- a. Without any load connected to the OUTPUT terminals and the POWER switch in the STDBY/RESET position, set the front-panel control as follows:

RANGE	As desired
VOLTAGE TRIP	To the lowest range that overlaps the desired trip voltage
VERNIER	Fully cw
CURRENT LIMIT METER	As desired Voltage
Readout Dials	Desired trip voltage

- b. Set the POWER switch from the STDBY/RESET position to OPR.
- c. Slowly rotate the VERNIER control counter-clockwise until the indicator lamp near the VOLTAGE TRIP switch illuminates and the red lamp near the POWER switch is extinguished. The voltage trip is now set to the value indicated on the readout dials and the instrument is tripped to the STDBY mode.
- d. To reset the instrument, set the readout dials to a value less than the trip voltage and place the POWER switch in the STDBY/RESET position, then to OPR.

### 2-13. Current Limit Setting

2-14 The CURRENT LIMIT control provides a means of limiting the amount of output current. If no limiting within the current range of the instrument is desirable, set the CURRENT LIMIT control to the fully clockwise position (60). Should some degree of current limiting be desirable, proceed as follows:

- a. With the POWER switch in the STDBY/RESET position, set the front panel control as follows:

RANGE	As desired
VOLTAGE TRIP and VERNIER	As desired
VOLTAGE CURRENT LIMIT METER	Fully clockwise Current
Readout Dials	1 volt

- b. Place a short across the OUTPUT terminal.
- c. Set the POWER switch to the OPR position.

- d. Adjust the CURRENT LIMIT control until the current indicated on the meter is the value of the desired limiting current.
- e. Place the POWER switch in the STDBY/RESET position. Remove the short. Current limiting is now set to the desired value for any output voltage.

### 2-15. Sense Connection

2-16. When a load is connected, there may be an appreciable voltage drop between the instrument and the load, depending on the length and pup of the connecting leads. The nomograph of Figure 2-2 can be used to determine the approximate voltage across the connecting wire lead.

2-17 Using the nomograph of Figure 2-2, lay a straight edge from the value of the output current, represented on scale 1, to the gauge of the connecting wires used, represented on scale 2. The voltage across the connecting wires, expressed in millivolts per foot, is obtained from scale 3. To determine the total voltage across the connecting wires, multiply the total length in feet by the value obtained from scale 3. For example, assume that two AWG No. 28 wires, each 3 feet long, are used to connect a load, requiring 50 milliamperes, to the Model 332B. With a straight edge, connect the known current on scale 1 (50 ma) and the wire size on scale 2 (No. 28). The resulting IR drop on scale 3 is approximately 3.2 millivolts per foot. Therefore, the connecting wires develop a total voltage of 19.2 millivolts (2 x 3ft x 3.2 mv/fts 19.2 mv), which is several times the published load regulation at 1000 volts output. To compensate for this, the instrument is equipped with remote sensing, which maintains regulation at the load. Consequently, the voltage across the connecting wire will have no effect. Determine if the wire lead used to connect the instrument to the load, will cause a voltage drop in excess of the load regulation specifications. If this voltage drop is excessive, remote sensing should be used. To prepare the instrument for remote sensing proceed as follows:

- a. With the POWER switch set to OFF, or to STDBY/RESET, remove the front-panel shorting link between the SENSE and OUTPUT terminals.
- b. Using a twisted pair of insulated wires, connect the +SENSE terminal to the positive side of the load, and connect the SENSE terminal to the negative side of the load.

**CAUTION**

Ensure that the **SENSE** terminals are connected to the load in the proper polarity. Incorrect connections will result in low of regulation and possible damage to the instrument.

between the power line grounds of the two instruments. This potential difference can cause circulating ground currents, which could cause errors in the output voltage. To prevent these errors from occurring, the instrument is equipped with a guard. This guard; when properly connected to the load, will provide a separate path for the circulating ground currents, thus eliminating possible errors in the output voltage. For proper connection, connect the **GUARD** terminal directly to the grounded side of the load, at the load. Figure 2-3 illustrates the correct **GUARD** terminal connection and the re-routed circulating ground current path.

**2-18. Guard Connection**

2-19. When the instrument is connected to another instrument (both instruments grounded through their respective power cords), a potential difference may exist

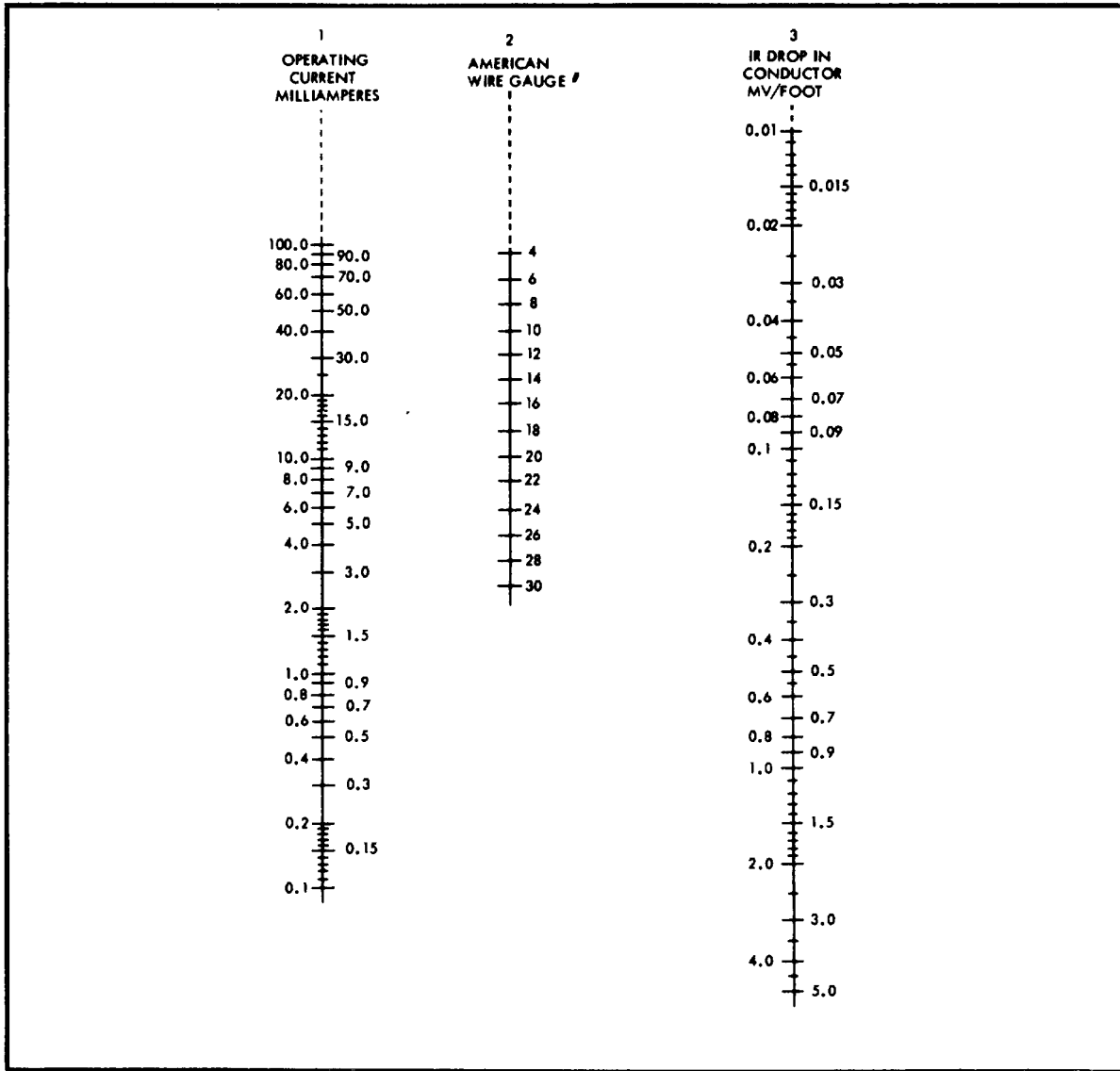

Figure 2-2. NOMOGRAPH OF VOLTAGE DROP ACROSS LOAD WIRES

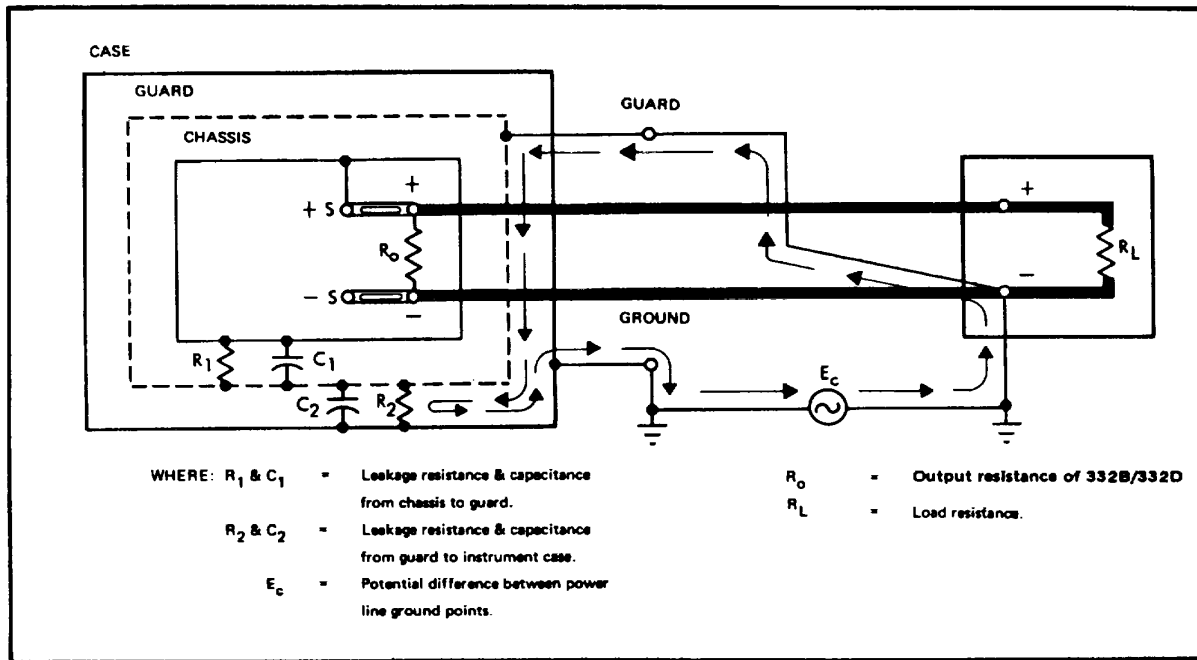

Figure 2-3. GUARD CONNECTION

## 2-20. Operation

2-21. Operate the instrument in accordance with the following procedure:

- a. Set the METER switch to VOLTAGE.
- b. Set the POWER switch in the STDBY/RESET position. Allow at least a 10 minute warm-up period, if the instrument has just been energized.
- c. Connect the SENSE terminals to the OUTPUT terminals with the shorting links provided.
- d. Set the CURRENT LIMIT control fully clockwise (60) or to a predetermined value, using the procedure of paragraph 2-13.
- e. Set the RANGE switch to the desired output voltage range (10, 100, or 1000).
- f. Set the VOLTAGE TRIP and VERNIER controls fully clockwise or to a predetermined value, using the procedure of paragraph 2-11.
- g. Set the readout dials to the value of the output voltage desired.
- h. If desired, connect the GUARD terminal to the grounded side of the load in accordance with

paragraph 2-18. The SENSE terminals may remain connected to the OUTPUT terminals. Should remote sensing be desired, connect the SENSE terminals to the load in accordance with paragraph 2-15.

- i. Connect the load to the OUTPUT terminals.
- j. Set the POWER switch to the OPR position.
- k. The output voltage provided to the load will be the voltage indicated on the readout dials. Should it be desirable to monitor the output current, place the METER switch in the CURRENT position.

## 2-22. APPLICATIONS

2-23. The Model 332B and 332D is designed for applications requiring a highly stable precision calibrator or reference voltage source. When operated in conjunction with a precision reference divider and a null detector, the Model 332B may be set to provide voltages of  $\pm 10$  ppm accuracy, traceable to the National Bureau of Standards. The unit may also be used as a dc differential voltmeter in combination with the null detector. These applications are described in the following paragraphs. The Model 332D will provide the above accuracy without additional equipment.

**2-24. Operation as a 10 PPM Calibrator**

2-25. The output voltage of the Model 332 may be standardized to the known emf of a standard cell by operating the Model 332 in combination with a Fluke Model 750A Reference Divider and a Fluke Model 845AB Null Detector. This instrument combination will provide voltages from 0.1 to 1100 volts with an accuracy of  $\pm 10$  ppm and trace ability to the National Bureau of Standards. For proper operation of this instrument combination, proceed as follows:

- a. Set the Model 750A controls as follows:

INPUT VOLTAGE ADJUST switch	RESET
INPUT VOLTAGE ADJUST controls (COARSE and FINE)	midposition
STANDARD CELL CIRCUIT switch	OPEN
STANDARD CELL VOLTAGE	value of standard to be used as desired
OUTPUT VOLTAGE switch	as desired

- b. Set the Model 332 controls as follows:

POWER	STDBY/RESET
VOLTAGE RANGE	as desired
Readout Dials	as desired
VOLTAGE TRIP and VERNIER	as desired
CURRENT LIMIT	2 ma

- c. Connect the equipment as illustrated in Figure 24. Ensure that the equipment connections are in the proper polarity.
- d. Adjust the Model 332 to provide an output voltage corresponding to the desired input voltage level of the Model 750A. Set the POWER switch of the Model 332 to OPR.
- e. Set the INPUT VOLTAGE switch of the Model 750A to the position corresponding to the dialed voltage of the Model 332.

**NOTE**

**Applied voltage must be 1.1 volt or greater to be adjustable to a standard cell**

- f. Place the STANDARD CELL CIRCUIT switch of the Model 750A to the MOMENTARY position and note the indication on the Model 845AB. Set the RANGE switch of the Model 845AB to increasingly more sensitive ranges while

adjusting the Model 332 readout until a zero indication is obtained on the Model 845AB on the 10 microvolt range.

- g. Calibration voltages of 10 ppm accuracy are now available at the OUTPUT VOLTAGE terminals of the Model 750A. The setting of the OUTPUT VOLTAGE switch should not exceed the input voltage.

**2-26. Operation as a 20 PPM Differential Voltmeter**

2-27. The Model 332, in combination with the Fluke Model 845AB Null DETECTOR may be operated as a differential voltmeter, with an accuracy of +20 ppm (+10 microvolts). Proceed as follows:

- a. Connect the equipment as shown in Figure 2-5.
- b. Set the RANGE switch on the Model 845AB to the approximate value of the voltage to be measured.
- c. Set the Model 332 controls as follows:

POWER	STDBY/RESET
VOLTAGE RANGE	Lowest range which covers approximate value of the unknown
Readout Dials	Approximate value of the unknown
METER	VOLTAGE
VOLTAGE TRIP	As desired
CURRENT LIMIT	2 ma

- d. Set the POWER switch of the Model 332 to OPR. The Model 845AB should indicate zero volts.
- e. Set the RANGE switch of the Model 845AB to increased null sensitivity and adjust the readout dials of the Model 332 for zero indication on the Model 845AB. Final null should be made on the 10 microvolt range of the Model 845AB. Accuracy of the measurement is as follows:

RANGE	ACCURACY
10	$\pm 20$ ppm (+10 uv)
100	$\pm 20$ ppm (+20 uv)
1000	$\pm 20$ ppm (+40 uv)

**2-28. Standard Cell Comparison**

2-29. The Model 332, in combination with a Model 845AB null detector, may be used as a transfer device for

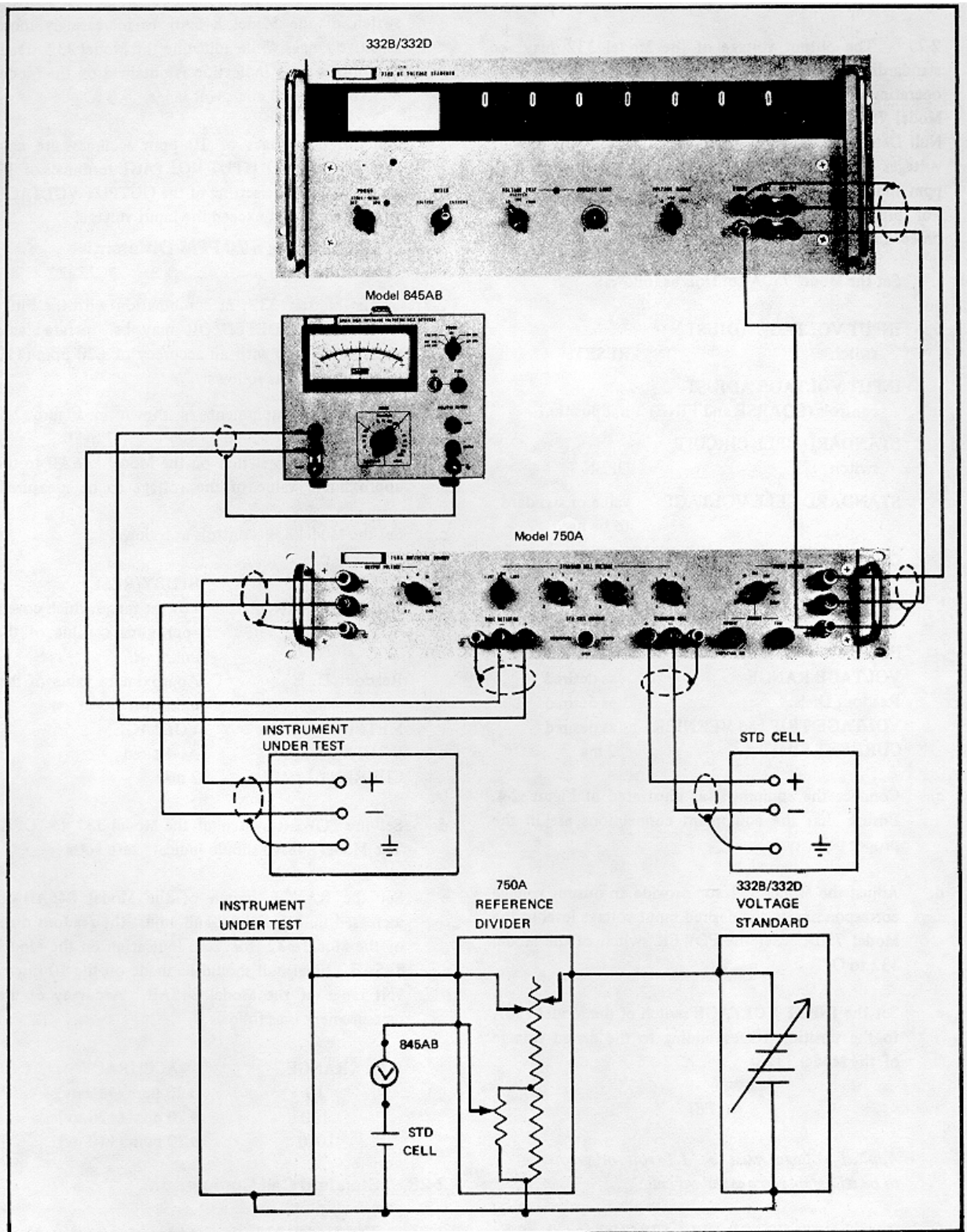

Figure 2-4. OPERATION AS 10 PPM CALIBRATOR

comparing voltages to 1.0 ppm resolution. An application is the comparison of saturated and unsaturated standard cells. Connect the equipment as shown in Figure 2-5. Determine the value of the unknown standard cell as follows:

- a. Using the Model 332 Model 845AB combination as a differential voltmeter, measure the voltage of the laboratory reference standard cell. The final null should be made on the 10 microvolt range of the Model 845AB. Record the readout of the Model 332 and label this value E1.

- b. Measure the value of the standard cell to be compared with the reference standard. Final null should be made on the 10 microvolt range of the Model 845AB. Record the readout of the Model 332 and label this value E2.

- c. Determine the value of the unknown standard cell (Ex) by using the following equations:

$$E_2 - E_1 = \Delta E \quad (1)$$

$$E_X = E_3 + \Delta E \quad (2)$$

Where:  $E_1$  = Value of the reference standard cell, as measured with the 332/845AB.

$E_2$  = Value of unknown standard cell, as measured with the 332 /845AB.

$E_3$  = Certified value of the reference standard cell.

$E_X$  = Calculated value of the unknown standard cell.

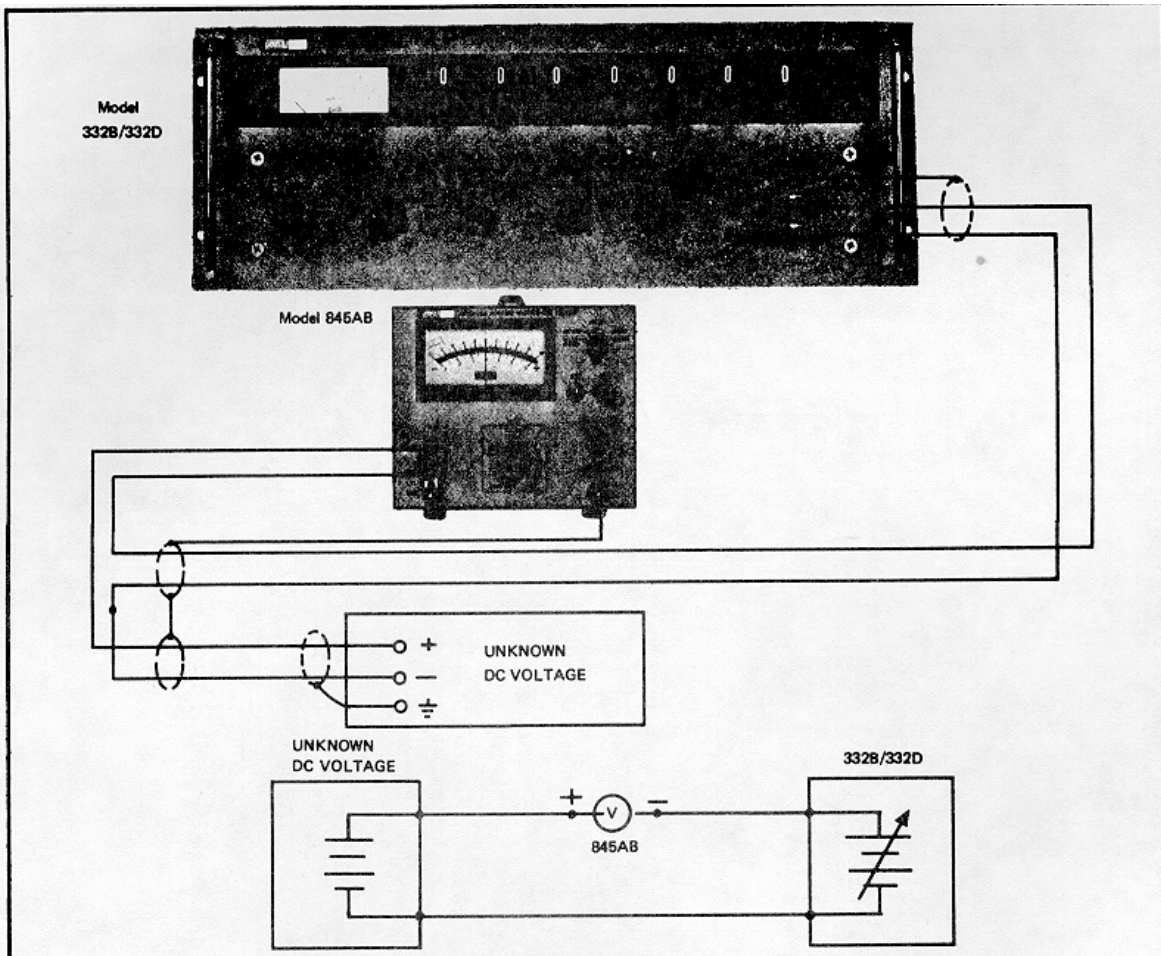

Figure 2-5. OPERATION AS 20 PPM DIFFERENTIAL VOLTMETER



## Section 3

## Theory of Operation

**3-1. INTRODUCTION**

3-2. This section describes the theory of operation of the Model 332B and 332D. Refer to the functional schematic diagrams in conjunction with the text. The diagrams are located in the rear of this manual following Section V. Persons doing trouble shooting should be thoroughly familiar with circuit operation before attempting to trouble shoot the unit in detail.

**3-3. FUNCTIONAL DESCRIPTION**

3-4. This voltage standard is a series regulated power supply basically consisting of the voltage control circuitry, pre-regulation circuitry, and protection circuitry. The voltage control circuits are the main regulation circuits and respond to load, RANGE, and readout dial change. Figure 3-1 illustrates a simplified schematic diagram of the voltage control circuitry. The error amplifier and series pass element, illustrated in the shaded portion, together constitute a dc. operational amplifier. The tendency of the operational amplifier is to maintain the summing point effectively at +SENSE potential. In this condition the output voltage of the voltage standard is equal to the ratio of the range in resistance ( $R_{\text{READOUT}}$ ) to the range resistance ( $R_{\text{RANGE}}$ ) times the reference ( $E_{\text{REFERENCE}}$ ), as illustrated in Figure 3-1. The constant reference voltage ( $E_{\text{REFERENCE}}$ ), in combination with the appropriate series resistance ( $R_{\text{RANGE}}$ ), provides a constant current to the sample string. Due to the constant current, the output is proportional to the resistance of the sample string ( $R_{\text{READOUT}}$ ). Since the tendency of the operational amplifier is to maintain the summing point at +SENSE potential, the output voltage is equal to the sample string voltage. Changing the setting of the readout dials (sample string) causes the output voltage to change

correspondingly. Each change in the RANGE switch setting causes the constant current to change by a factor of 10, thus the output voltage changes by the same factor. A detailed block diagram is illustrated in the Functional Block Diagram (332B-1000), following Section V. In this diagram, the chopper amplifier, differential amplifier, and series pass driver constitute the error amplifier of Figure 3-1.

3-5. Series regulated power supplies have the inherent disadvantage of low efficiency. When providing a low level output, the series pass element of the supply must dissipate the bulk of the power supplied by the high voltage transformer circuit. In this instrument, a uniJunction oscillator circuit monitors the voltage across the series pass element and provides a voltage level information to a pre-regulation circuit. The pre-regulation circuit utilizes this information to provide full- control of the input line voltage to the primary of the high voltage transformer. Thus, the power supplied by the high voltage transformer is controlled to provide only that amount necessary for the load requirements. This in turn increases the overall efficiency of the instrument. This also accounts for symbolizing the unregulated dc voltage, in Figure 3-1, as a variable dc voltage.

3-6. Circuitry, for protection of personnel as well as external equipment, is provided. The instrument contains an interlock system to energize the high voltage circuit within the instrument when the covers are removed. A limit may be set for the output voltage and/or current. Whenever the output voltage or current tries to exceed the set limits, the instrument output is de-energized. Therefore, sensitive external equipment can be protected from excessive voltage and current.

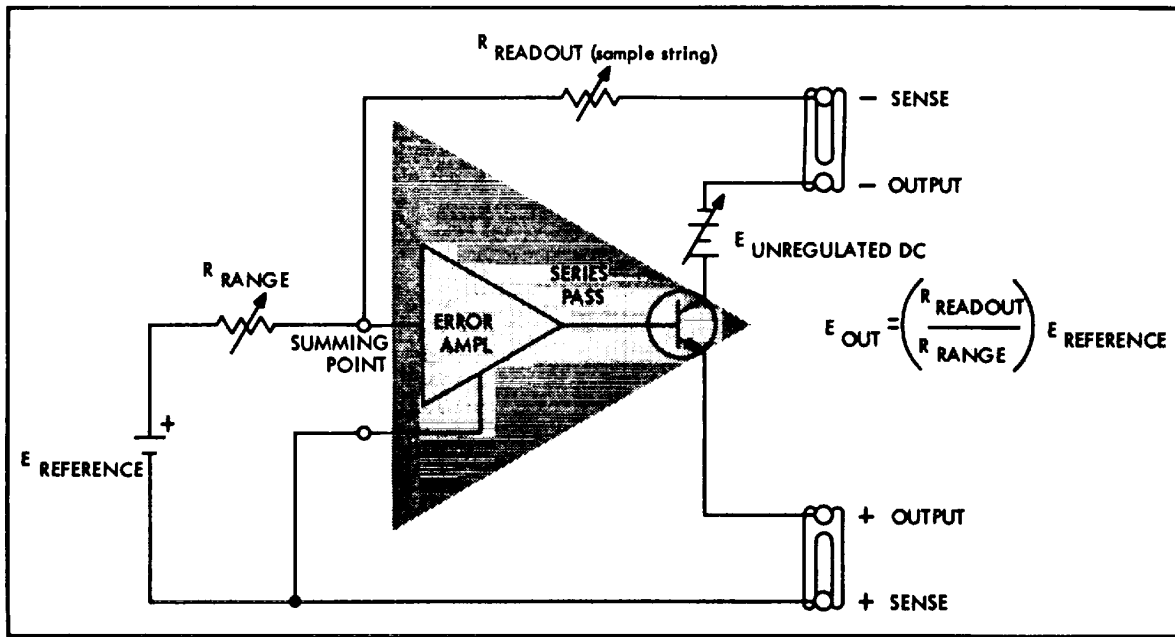

Figure 3-1. VOLTAGE CONTROL CIRCUITRY

### 3-7. CIRCUIT DESCRIPTIONS

#### 3-8. Voltage Control Circuitry

3-9. Reference Circuit The basic reference voltage for the instrument is supplied by zener diode CR1402. This diode is located in a proportionally controlled oven on the Muter Voltage Reference P/C Assembly (A5A1 Schematic 332B-1002). Current through the reference zener diode is maintained constant by a constant current source consisting of Q1401, CR1401, R1403, and R1. These components, except for R1, are also contained in the oven assembly for environmental stability.

3-10. A constant temperature is maintained in the proportionally controlled oven by the temperature regulating circuitry, located on the Muter Voltage Reference P/C Assembly (ASA1). The temperature regulator circuitry consists of a differential amplifier (Q3 and Q4), a Darlington amplifier (Q1 and Q2) and associated circuitry. One input to the differential amplifier, the base of Q3, is connected to common. Consequently, the output current from the collector of Q3 is proportional to the current into the base of Q4: The temperature coefficient of R1402 is negative. Therefore as temperature decreases, the current of Q4 increases, which increases the base drive of Q2. The increased current into the base of Q2 increased the current through the heater (R1401). Because of the Darlington configuration of Q1 and Q2, a small change in current

into the base of Q2 results in a significant change in current through R1401, thus providing close regulation of the oven temperature.

3-11. The constant output voltage from the reference zener diode is applied to the Reference Calibration P/C Assembly (A4.Schematic 332B-1001). This assembly provides three constant operating currents to the sample string for the three output range. The zener reference diode provides a constant voltage of approximately 63 volts. This voltage is reduced by R1, calibration adjustment R2, and R3 to 6.02 volts. Registers R9 and R10 provide a millampere current for the 1000 volt range. Registers R7 and R8 provide a 0.1 millampere current for the 100 volt range. Resistors R4, R5, and R6 provide a 0.01 millampere current for the 10 volt range. One of the three currents is selected and supplied to the sample string, depending upon the position of the RANGE switch.

3-12. The Sample String P/C Assembly (A2Schematic 332B-1003) is a resistance string whose value is controllable by the front-panel readout dials. The resistance of the sample string is such that the constant current through it develops a voltage equal to the value set on the readout dials.

3-13. Chopper Amplifier. The voltage at the running junction is applied through pin 5 to the junction of R1 and R4 on the Differential Am P/C Assembly

(ASA3 Schematic 332B-1002). One path is provided for dc changes through R1 and pin 6 to the input of the Chopper Amplifier P/C Assembly (A5A4Schematic 332B1002). The other path is for ac changes through the differential amplifier circuitry to be described later. The chopper amplifier compares the summing point voltage to the + sense voltage and provides an amplified dc error signal proportional to the difference. The + sense voltage is applied through a divider network; consisting of R7 through R12 located on the Temperature Regulator P/C Assembly (A5A1-Schematic 332B-1001), at pin 5. This network provides an internally adjustable dc bias to the chopper amplifier for compensation of offset voltages when the Model 332 is set to zero output.

3-14. The mechanical chopper, G1, samples the difference between the summing point voltage and the compensated + sense voltage at a 60 Hz rate. The resulting waveform is applied to the gate of Q1. Transistor Q2 amplifies the output of Q1. Transistors Q3 and Q4 are direct coupled amplifiers, with negative feedback applied from the collector of Q4 to the emitter of Q3. Transistor Q5 is a para-phase amplifier, which provides two essentially identical waveforms differing in phase by 180°. The two waveforms are demodulated by chopper G1 and filtered by R24, R25, C14, and C15. This amplified dc error signal is then applied to one input of the Differential Amplifier P/C Assembly (ASA3) at pin 3.

3-15. Differential Amplifier. Error signals in the form of ac changes are applied to the differential amplifier through C1 to the gate of Field Effect Transistor (FET) Q2. Error signals appearing as dc changes are applied to the chopper amplifier at the base of Q6. Using a separate path for ac changes allows rapid regulation of the output voltage for rapid changes in load requirements. The Differential Amplifier P/C Assembly provides an output that is proportional to the amplified dc error signal from the Chopper Amplifier P/C Assembly.

3-16. Use of a Field Effect Transistor for Q2 provides high input impedance and low noise. Transistor Q8 is a current source for one stage of the differential amplifier. Use of the current source provides high gain and good common mode rejection at the input of the amplifier. The compound configuration of Q4-5 and Q6-Q7 provides high input impedance and minimizes temperature effects. The output signal from the collector of Q9 is applied to the base of the common collector amplifier Q11. Transistor Q11 provides impedance matching between the high output impedance of Q9 and the low input impedance of the series pass driver circuit.

**3-17. Series Pass Driver.** The Series Pass Driver P/C Assembly (ASA2-Schematic 332B-1001), accomplishes

two functions. One function is to de-energize the output in the case of an overvoltage or overcurrent condition, which will be described later. The other function is to provide sufficient drive current for error signals to the series pass element. Transistors Q5, Q6, Q7 and associated circuitry constitute the driver portion. Transistor Q7 is a common base amplifier which provides part of the voltage gain necessary for control of the series pass element. Current gain is provided by common collector amplifiers Q6 and Q5. The output of Q5 is applied to the main series pass transistor Q8, on the Series Pass Element P/C Assembly (A7A1Schematic 332B-1001).

**3-18. Series Pass Element.** The series connection of transistors Q1 through Q8 constitute the series pass element. This element is located on the Series Pass P/C Assembly (A7A1-Schematic 332B-1001). Transistors Q1 through Q7 are normally saturated by the base voltage supplied by the 150 volt power supply. Consequently, the entire voltage drop required for regulation is across Q8. Should the OUTPUT terminals be shorted or should the instrument be rapidly down-ranged, the voltage across Q8 may exceed 150 volts. Should this occur, transistors Q1 through Q7 will come out of saturation to share the voltage drop. The pre-regulator circuitry (paragraph 3-23), sensing the increased voltage across Q8, decreases the unregulated supply voltage. As soon as the voltage across Q8 decreases below 150 volts, Q1 through Q7 become biased to saturation and Q8 absorbs the entire regulation voltage.

3-19. Power Supplies. Operating voltages for the temperature regulating circuit, zener reference circuit, chopper amplifier, and differential amplifier are provided by the Auxiliary Power Supply P/C Assembly (ASAS-Schematic 332B-1004). The auxiliary power supply consists of the 25 volt supply and -15 volt supply circuits. The auxiliary supply reference element is located in the 25 volt supply. The output of the 25 volt supply is then used as the reference for regulation of the -15 volt supply.

3-20. In the 25 volt supply, CR1 through CR4, C2, R4, and C3 provide unregulated dc voltage to the regulation circuitry consisting of Q2 through Q6. Transistors Q5 and Q6 constitute a differential amplifier. The base of Q6 is held at a constant voltage by zener diode CR6. The base of Q5 is connected to a voltage divider, consisting of R8, R9, and R10, referenced to the output of the supply. Variations in the +25 volt output of the supply are sensed at the base of Q5. Any difference between the base voltages of Q5

and Q6 is amplified by the differential pair and applied from the collector of Q5 to the base of series pass driver Q3. The amplified error signal controls the conduction of Q3, which in turn controls the series pass element Q4. Transistor Q2 is a constant current source to supply base drive to Q3.

3-21. In the -15 volt supply, CR7 through CR10, R14, and C8 provide the unregulated dc voltage to the regulating circuit consisting of series pass element Q7 and differential pair Q8 and Q9. The base of Q9 is connected to a voltage divider referenced to the +25 volt supply output. The base of Q8 is connected to the positive side of the -15 volt supply. Variations in the output voltage are sensed at the base of Q9. Any difference between the base voltages of Q8 and Q9 is amplified by the differential pair and applied from the collector of Q8 to the base of series pass element Q7. The amplified error signal controls the conduction of Q7 and consequently the magnitude of the output voltage. The positive side of the -15 volt supply is connected to the negative side of the +25 volt supply through pins 11 and 12. The + sense line is connected to this junction and is the common for the auxiliary power supply.

3-22. The +35 volt operating voltages for the series pass driver circuitry, on the Series Pass Driver P/C Assembly (ASA2), is provided by a power supply located on the Current Limiter P/C Assembly (ASA6 Schematic 332B1102). In the diode bridge configuration of CR1 through CR4, diodes CR1 and CR2, R1 and R2 provide a positive unregulated dc voltage. Diodes CR3 and CR4, R4, and C4 provide negative unregulated dc voltage. The positive unregulated dc voltage is applied to the regulating circuit of Q1 and CR5 and through a voltage divider to the RANGE switch, for application to the appropriate decimal lamp. The 36 volt reference voltage, established by CRS, provides the input signal for the emitter follower configuration of Q1. This emitter follower configuration provides the necessary low output impedance and power gain of the power supply. The -35 volt supply functions in the same manner as the +35 volt supply.

### 3-23. Pre-Regulation Circuitry

**3-24. Oscillator.** A unijunction oscillator, consisting of Q9 and associated circuitry, is located on the Series Pass Element P/C Assembly (A7A1-Schematic 332B-1001). Applied to base two of Q9 is a 6.8v clipped, full-wave rectified, 60 Hz sine wave. The potential at the emitter of Q9 depends upon the charge of C4 and CS. The charge of CS depends upon the voltage across the main series pass element, Q8. At the trailing edge of each pulse at the base two of Q9, the oscillator provides a series of positive pulses until the leading edge of the

next +6.8 volt pulse 34 occurs. With an increased charge across C4 and CS, the initial output pulse of the oscillator will occur earlier in each half cycle. The initial pulse from the oscillator during each half cycle will switch the pre-regulator off to control the amount of line power supplied to the high voltage transformer. If the series pass element voltage of Q8 increases, the pre-regulator is switched off earlier in each half cycle. This in turn reduces the series pass element voltage of Q8 to its equilibrium value.

3-25. The +6.8 volt operating voltage for the oscillator circuit is taken from the +150 volt supply for the series pass element. A portion of the +150 volt supply is applied to the voltage divider consisting of R1 through R3. The divided-down voltage is regulated by zener diode CR6 to approximately +6.8 volts.

**3-26. Pre-regulator.** The series of unijunction pulses are coupled across T1 to the input of the pre-regulator on the Pre-Regulator P/C Assembly (A7A2-Schematic 332B-1001). At the beginning of each 60 Hz half cycle, Q5 is turned on by the positive going +V voltage through R17 and L2. Conduction of Q5 saturates Q4, Q2, and Q1 (pre-regulator control transistor). Conduction of Q1 allows current to flow in the primary of the high voltage transformer. Sometime during each half cycle, the initial pulse from the unijunction oscillator will trigger the regenerative pair (Q6 and Q7) into saturation. With Q6 and Q7 conducting, Q5, Q4, and Q1 turn off and remain off as long as Q6 and Q7 are conducting. Transistors Q6 and Q7 remain conducting until the end of each half cycle. At this time, the current through them automatically drops below the regenerative value, due to the zero crossing of the full-wave rectified 60 Hz sine wave voltage (-V) at the emitter of Q7. Therefore transistor Q1 is held off for the remainder of the half cycle. This limits the amount of power to the high voltage transformer and reduces the power dissipation requirements for the series pass element.

3-27. Operating voltages for the pre-regulator circuitry are provided by the diode bridge configuration of CR1 through CR4. Diodes CR2 and CR4 provide a negative full wave rectified voltage for -V. Diodes CR1 and CR3 provide a positive full-wave rectified voltage for +V. A portion of the +V voltage is filtered by C4 and CS to provide the +10 volt supply voltage. Diode CR5 serves to isolate the +V voltage from the filter capacitors.

### 3-28. Protection Circuitry

**3-29. Trip.** The purpose of the trip circuit is to remove ac power from the primary of the high voltage transformer

and open the negative output path, if an overvoltage or catastrophic overcurrent condition exists. The trip circuitry is located on the Series Pass Driver P/C Assembly (A5A2 Schematic 332B-1001). Transistor Q3 is a constant current source for relays A7K1 and A7A2K2. With A7A2K2 (on the Pre-Regulator P/C Assembly) closed, current is provided to A7A2K1 which completes the primary circuit for the high voltage transformer. With relay A7KI (on the High Voltage Mother-board P/C Assembly) closed, the negative output path is completed and power may be supplied to the load. The current sensing resistor, R22, is effectively connected through R24 to the base of normally off Q4. In the event of a catastrophic failure, in which the current limiting circuitry would not function, an excessive current approaching 120 milliamperes would develop sufficient voltage across R22 to turn on Q4. Because of the regenerative configuration, transistors Q4 and Q2 would become saturated. With Q2 saturated, the potential at pin 10 becomes nearly the same as the positive buss potential. This bypasses the current away from the relays, which causes them to open. With the relays open, the OUTPUT terminals are de-energized, the input power to the high voltage transformer is interrupted, and the OPR indicator lamp goes out. To reset the instrument, the POWER switch is placed in the STDBY/RESET position; then to the OPR position after the cause of the overload has been corrected. With the POWER switch in the STDBY/RESET position, the circuit common is connected through a section of the POWER switch and pin 10 to the emitter of Q2. This results in turning off both Q2 and Q4, and thus returning them to their original state.

3-30. The overvoltage trip element is Q1. The base of Q1 is connected to R15 and the appropriate resistor selected by the VOLTAGE TRIP switch. The voltage trip point is selected by the VERNIER control (RS), which sets a reference bias on Q1 (maintaining Q1 cut off). As the output voltage increases, the voltage at the base of Q1 increases negatively until it exceeds the selected trip voltage and causes Q1 to conduct. The conduction of Q1 saturates Q2 and results in de-energizing the instrument output terminals, as previously described.

**3-31. Current Limit.** The current limit circuitry, located on the Current Limiter P/C Assembly (A5A6-Schematic 332B-1002), provides a means of varying the limiting point of the output current. Current sensing resistor R22, on the Series Pass Driver P/C Assembly (ASA2), provides a voltage to the current limiter circuit that is proportional to the output current. This voltage is applied through pin 10 and CR12 to the base of Q5. The emitter of QS is connected to the wiper of the CURRENT LIMIT control 3328/3320 (R6), which provides a variable bias for the base-emitter junction. Transistor Q5 is normally

off. However, when the output current exceeds the set limit, Q5 turns on. Conduction of Q5 causes both Q4 and Q3 to conduct. Conduction of Q3 causes Q1, on the Differential Amplifier P/C Assembly, to conduct and bypass some of the sample string current. This causes the output voltage to be reduced and consequently the output current is reduced. The conduction of Q3 also turns on the regenerative pair, Q6 and Q7, which supply current to the red indicator lamp.

**3-32. Interlocks.** The Model 332 is equipped with an interlock circuit for personnel safety. When either the top or bottom inner covers or printed circuit assemblies A7A2, A7, A7A1, A5A1, A5A3, A5A4, A5A5, or A5A6 are removed, the ground return for the A7KI and A7A2K2 relays is opened. This results in removal of the input power to the high voltage transformer (T2) and opens the negative output side of the instrument.

**3-33. Time Delay.** The purpose of the time delay circuit, located on the Time Delay P/C Assembly (A6Schematic 332B-1001), is to provide a short interval for the auxiliary voltages to rise to nominal value. This ensures that the control amplifiers are operating before the high voltage is available. The time delay circuit momentarily holds open relays A7KI and A7A2K2, which prevent the closure of A7A2K1. The time delay is approximately 3 seconds. Diodes CR1 and CR2 provide a full-wave rectified voltage from a secondary winding of the power transformer between pins 20 and 22. When the POWER switch is in the STDBY/RESET position, a small current flows through R2001, S1c, K2001, R2004, and C2001. This current, although too small to actuate. K2001, charges C2001. Capacitor C2001 charges until it reaches the firing point of Q2001, approximately 2 to 3 seconds. At this point Q2001 conducts, increasing the current through K2001. The relay actuates and closes contact K2001A (which provides the current path when the POWER switch is in the OPR position) and opens contact K2001B. When K2001B opens, the grounding circuit is removed from the constant current source supplying A7KI and A7A2K2, and these relays are allowed to actuate.

### 3-34. Miscellaneous Circuitry

**3-35. Output Circuit Current Source.** In addition to the main high voltage bridge rectifier, CR1 through CR10 on the High Voltage Mother Board P/C Assembly (A7Schematic 332B-1001), there is another high voltage bridge (CR13 through CR20). This bridge-rectifier is in series with R27 and R28 and forms a quasi-constant current source. This current flows through the series pan transistor and 36

acts as a minimum load to insure that their transconductance is held above a minimum value. Another purpose of the quasi-constant current source is to provide a quick discharge path for the output capacitor C1, when down ranging. This helps to reduce the setting time.

**3-36. Capacitor Switch.** The capacitor switch circuitry is located on the Capacitor Switch P/C Assembly (A3Schematic 332B-1001). When down ranging from 1000 volts, capacitor C4 (on the chassis) will tend to charge to a voltage level proportional to the difference between the charge on CS and the parallel combination of the output capacitors C1 and C2. If this difference is too great, C4 will receive a charge of sufficient magnitude to cause a dielectric absorption problem, thus excessive settling time will result. (Dielectric absorption is the tendency of the dielectric material of the capacitor to absorb and retain a small charge). To prevent this occurrence, CS is discharged through R7 (on A3) when the RANGE switch is down ranged from 1000 volts to 10 or 100 volts. In doing so the decay rate of C5 and the parallel combination of C1 and C2 will be equal, thus C4 does not receive an over charge. After C5 has discharged sufficiently (several seconds), the K1A contacts (on A3) close and parallel the low resistance of R6 with R7. This essentially shorts CS and returns the loop gain to the required amount. The capacitor switch circuitry is responsible for allowing a time delay before closing the K1A contacts. When down ranging from 1000 volts, C1 is charged by the +35 volt supply through R2 and R1. After several seconds, C1 accumulates a sufficient charge to cause Q1 to conduct. Conduction of Q1 energizes relay K1 which closes the K1A contacts.

**3-37. Crowbar Circuit.** If the output voltage were suddenly turned to zero with a load connected to the instrument, the voltage across the filter capacitors C1, C2, and C3 (located on the High Voltage Mother Board P/C Assembly, A7) would appear across the series pass transistors. This voltage could damage the series pass transistors. To protect the series pass transistors from this kind of damage, a "crowbar" circuit is utilized. (The term "crowbar" is derived from the use of such a device to discharge large capacitor banks in transmitter power supplies). The "crowbar" circuit consists of transistor Q10 and associated circuitry on the Series Pass Element P/C Assembly, A7A1. It also includes relay K2 on the High Voltage Mother Board P/C Assembly, A7. When the voltage across the series pass element reaches approximately 225 volts, transistor Q10 conducts. Since relay K2 is in the collector circuit of Q10, the relay is energized and closes the contacts. With the K2A contacts closed, a discharge path through R15 is provided for the filter capacitors.

**3-38. Meter Circuit.** The front panel meter indicates the output voltage or output current, depending on the position of the METER switch. When the METER switch is in the VOLTAGE position, resistors R3 through R6, on the Series Pass Driver P/C Assembly, and the resistors selected by the RANGE switch S2f provide the meter with a current which is proportional to the output voltage. When the METER switch is in the CURRENT position, resistors R1 and R2, on the Series Pass Driver P/C Assembly, provide the meter with a current which is proportional to the output current.

## Section 4

## Maintenance

**4-1. INTRODUCTION**

4-2. Information concerning the maintenance and calibration of the Model 332B and 332D is contained in this section. Paragraph 4-6, GENERAL MAINTENANCE, covers unique and miscellaneous maintenance procedures. A series of checks to determine if the instrument operates properly plus information to aid in localizing problem area, should any of these checks fail, b covered under paragraph 4-20, PERFORMANCE TESTS. Paragraph 4-36, CALIBRATION, contains procedures for alignment of circuit and final accuracy adjustments.

**4-3. SERVICE INFORMATION**

4-4. Each instrument manufactured by the John Fluke Manufacturing Company is warranted for a period of one year upon delivery to the original purchaser. Complete warranty information is contained in the Warranty page located at the front of this manual.

4-5. Factory authorized calibration and repair service for all Fluke instruments are available at various world wide locations. A complete list of factory authorized service centers is located at the rear of this manual. If requested, an estimate will be provided to the customer before any repair work is begun on instruments beyond the warranty period.

**4-6. GENERAL MAINTENANCE****4-7. Maintenance Access**

4-8. The chassis may be easily removed from the outer case by unfastening the two Dzus fasteners, located at the rear of the cue. To obtain access to the circuitry within the chassis, the top and/or bottom inner covers must be remove ed. Removal of the top and/or bottom covers opens one or .both of the interlock

twitches. To have the instrument fully operable, with the top and/or bottom covers off, the interlocks must be "cheated".

**DANGER**

**The inner chassis at +OUTPUT potential Hazardous voltage may exist ion chassis**

4-9. Located on the left hand side of the instrument, behind the second bulkhead, is an extender card. This board is used a an extender for the plug-in circuit board assemblies to provide access to adjustments and test points. Simply remove the plug-in circuit board assembly to be investigated, insert the extender card in its place, and plug the circuit board assembly in the extender card.

**4-10. Unique Maintenance Procedure**

**4-11. Cleaning of boards.** Certain circuit board assemblies are ultrasonically cleaned at the factory to prevent the possibility of electrical leakage caused by contamination from handling during assembly. These circuit board assemblies include the Sample String P/C Assembly (A2), and Capacitor P/C Assembly (AI). When components are replaced on these assemblies that require soldering, the land pattern side of the board should be cleaned u described in paragraph 4-13. Should contamination be suspected on the component side of the circuit board, use Freon TF Degreaser (Miller-Stephenson Chemical Co.).

**4-12. Shielded Capacitors.** On the Chopper Amplifier P/C Assembly (ASA4), capacitors C1 through C4 are wrapped with adhesive copper foil for shielding purposes. Should any of these capacitors need replacing, wrap the new capacitor(s) with the original copper foil (if the ad

hesive needs to be activated, use (GM NAMEPLATE INC.). If the original copper foil is not salvageable, wrap a new piece of copper foil (Permacel-type EE3990 or Mystik Tapetype 7420) around the capacitor. Insure that the copper foil does not extend beyond the edges of the capacitor and touch either of the leads. Solder one end of a length of No. 22 buss wire to the copper foil and the other end to the associated printed circuit board land.

**4-13. Circuit Board Sealant.** The land pattern side of all printed circuit boards have been coated with epocast (a polyurethane resin) to inhibit fungus growth and moisture absorption. When soldering to a printed circuit land, the heat from the soldering iron decomposes the epocast resin, leaving a charred residue. Upon completion of soldering, the residue should be removed with a solvent, such as toluol.

**CAUTION**

**The following precautions should be adhered to when us toluol: avoid inhaling the upon, avoid excessive contact with the skin, and keep away from open flame. Inure that plastic components do not come into contact with toluol, since it will dissolve most types of**

After removal of the epocast residue, the affected area should be recoated with a sealant. A spray can of Circuit Coat (Furane Plastic Inc., 4516 Brazil Street, Los Angeles, California or 16 Spielman Road, Fairfield, New Jersey) may be used for recoating.

**4-14. Fuse Replacement**

4-15. The fuses are contained in bayonet type fuse holders located at the rear of the instrument. Listed below are the correct values for the fuses:

REF.	FUNCTION TYPE	DESIGN
F1	High Voltage	¼ A, slow blow
F2	Line	+3A, slow blow, 115V conn. 1 ½ A, slow blow, 230V conn.

Under no circumstances should replacement fuses with higher current ratings be installed in the instrument.

4-16. Lamp Replacement 4-17. The indicator lamps are located immediately behind the front panel. The instrument must be partially re4-2 moved from the case to gain access to the lamps. The decimal lamps

are easily accessible and removable from the top of the instrument without the need of any special tools. To replace either the over current-voltage lamp or the operate lamp, remove the screw securing the lamp holder to its mounting, then remove the bayonet base lamp.

**4-18. 115/230V Conversion**

4-19. Depending upon the connection of the power transformers primary windings, the instrument may be operated from either a 115 or 230 volt ac power line. To convert the instrument from one type of power line operation to the other, use the following procedure:

- a. Disconnect the line cord from the power line.
- b. Remove the instrument from the case and place upside down on a suitable work space.
- c. Orient the instrument and perform the appropriate electrical connections as illustrated in Figure 4-1.
- d. Use the proper fuse corresponding to the selected conversion, as discussed in paragraph 4-14

**4-20. PERFORMANCE TESTS**

**4-21. Introduction**

4-22. The following tests are intended for checking the performance. These tests may be used for incoming inspection, periodic inspections and pre-calibration checks. It is recommended that these tests be performed prior to each calibration.

4-23. Each performance test includes an introductory paragraph which states the purpose of the test and describes the circuitry involved. An understanding of the purpose of each test and the circuitry involved should aid a technician in analyzing a malfunction.

4-24. During the following tests, it will not be necessary to remove the instrument from the case. Al external equipment will be connected to the terminals provided on the instrument. Figure 4-2 lists the equipment needed for testing and calibrating.

4-25. The load, line and ripple checks do not rely on any calibration adjustments; any major or minor indication should be investigated by troubleshooting. The remaining voltage standard checks do rely on proper calibration



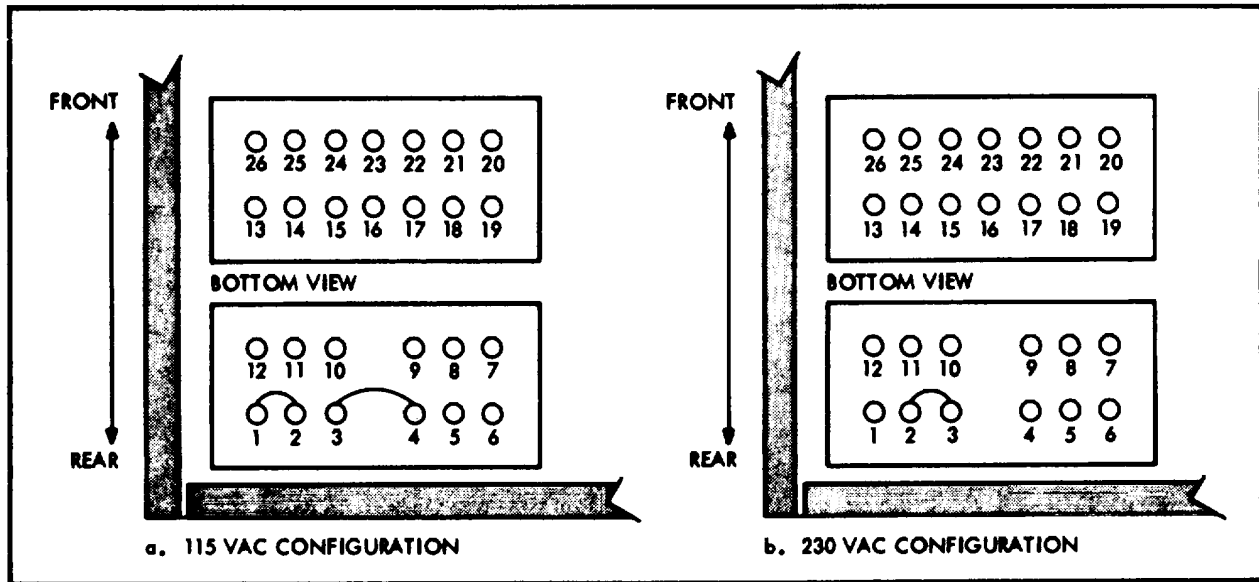

Figure 4-1. 115/230 VAC CONVERSION

EQUIPMENT REQUIRED	SPECIFICATIONS REQUIRED
Volt/Ohmmeter - RCA VoltOhmyst or equivalent	DC Accuracy of $\pm 3\%$ and input impedance of $10\text{ M } \Omega$
Metered Autotransformer - General Radio Variac W5MT3A or equivalent	Output of 0 to 130 vac at 3 amperes.
DC Differential Voltmeter - Fluke Model 885A or equivalent (quantity of 2 required)	DC Accuracy of $\pm 0.0025\%$ with 100 uv null detector
RMS Voltmeter - Fluke Model 931B or equivalent	Accuracy of 1% from 50 Hz to 30 kHz
Preamplifier	Gain of 1000 and bandpass of 10 Hz to 10 kHz
Oscilloscope - Tektronix Type 541 or equivalent Preamplifier - Tektronix Type L	General purpose  5 mv / cm sensitivity
General Purpose Power Supply	Provide 5.5 volts
DC Milliammeter	0 to 100 milliamperes $\pm 5\%$
Load Resistor Box - Clarostat 240 -C	Resistance range of 20 to $20,000\Omega$ at $\pm 5\%$ . Capable of handling up to 80 watts
Resistor, Composition	$100k\ \Omega \pm 5\%$ , $\frac{1}{2}w$

Figure 4-2. TEST AND CALIBRATION EQUIPMENT REQUIRED (Sheet of 1 of 2)

EQUIPMENT REQUIRED	SPECIFICATIONS REQUIRED
Lead Set	Low-leakage, low-thermal emf
Standard Cell Enclosure- Guildline Model 9152	Accuracy of $\pm 0.0003\%$
DC Voltage Calibration System - Fluke Model 7101B consisting of the following equipment, or an equivalent system: Voltage Standard, Model 332B/332D Null Detector, Model 845AR Voltage Divider, Model 750A Kelvin-Varley Voltage Divider, Model 720A	Capable of measuring 0.1 to 1100 vdc with 5 ppm accuracy

Figure 42. TEST AND CALIBRATION EQUIPMENT REQUIRED (Sheet 2 of 2)

adjustments. Should minor out of tolerance indications be observed during these checks, calibration will more than likely correct these problems. However, should the calibration adjustments be ineffectual or at their extreme limits, you will have to investigate the cause of the problem.

4-26. In the event that a malfunction is discovered, complete as many of the performance tests as possible. Record which tests the instrument does not successfully pass and any abnormal indications. This will help in analyzing the problem and lead to more efficient troubleshooting.

#### 4-27. DC Output

**4-28. Line Regulation.** The line regulation test determines whether the output voltage will remain constant, within specified limits, for a low to high line input power

- Connect the line cord through an auto transformer connected to an ac power line. Set the auto transformer to 115 volts ac.
- Set the front panel controls as follows:

POWER	STDBY/RESET
METER	CURRENT
RANGE	10
READOUT	All Zero
VOLTAGE TRIP	1000
VERNIER	Clockwise
CURRENT LIMIT	Clockwise (60)

- Connect the Model 885A to the SENSE Terminals and the 240-C Load Resistor Box to the OUTPUT terminals of the Model 332B/332D.
- Set the RANGE switch, readout dials, and load box to the values indicated in the group of settings in Figure 4-3. Set the POWER switch to the OPR position. Note the voltage indicated on the Model 885A. Set the autotransformer to 103 volts ac. The output voltage change, indicated on the Model 885A, should not exceed the 20 microvolt specification listed in Figure 43. Return the autotransformer setting to 115 volts ac. Note the voltage indication on the Model 885A. Set the autotransformer to 127 volts ac. The voltage change, indicated on the Model 885A, should not exceed the 20 microvolt specification. Repeat this procedure for each group of settings in Figure 4-3.

**4-29. Load Regulation.** The load regulation test determines if the output voltage will remain constant, within specified limits, when the output is subjected to a no-load to full load condition.

- Connect the line cord to an autotransformer connected to an ac power line. Set the autotransformer to 115 volts ac.
- Set the front panel controls as follows:

POWER	STDBY/RESET
METER	CURRENT
RANGE	10

Readout All Zero  
 VOLTAGE TRIP 1000  
 VERNIER Clockwise  
 CURRENT LIMIT Clockwise (60)

POWER STDBY/RESET  
 METER CURRENT  
 RANGE 10  
 Readout All Zero  
 VOLTAGE TRIP 1000  
 VERNIER Clockwise  
 CURRENT LIMIT Clockwise (60)

- c. Connect the Model 885A to the SENSE terminals.
- d. Set the autotransformer to 103 volts ac.
- e. Set the RANGE switch and Readout Dials to the values indicated in the first group of settings listed in the Figure 4-4. Set the POWER switch to the OPR position. Note the voltage indicated on the Model 885A. Connect the 20-ohm load to the OUTPUT terminals and note output voltage change on the Model 885A. The change should not exceed the specification listed in the chart. Repeat the procedure with the autotransformer set to 127 volts ac. Repeat steps d and e for each group of settings.

- c. With the autotransformer set to nominal line voltage (115 vac), set the POWER switch to OPR. The ripple output should not exceed 20 microvolts.

**NOTE**  
*Ripple indication is via 1000X preamplifier.*

- d. Set the readout dials to 10 volts. The ripple output should not exceed 20 microvolts rms.
- e. Connect the 200-ohm load resistor to the OUTPUT terminals. The ripple output should not exceed 20 microvolts rms. Disconnect the load resistor.
- f. Set the readout dials to zero, and set the RANGE switch to 100. The ripple output should not exceed 30 microvolts rms.

**4-30. Ripple.** The ripple test determines if ac component superimposed on the dc output is within specified limits.

- a. Connect the preamplifier to the OUTPUT terminals. Connect the Model 931 RMS Voltmeter to the output of the preamplifier.
- b. Set the front panel controls as follows:

RANGE	READOUT	LOAD (50 ma)	SPEC.
10	1	20Ω	10 uv
10	10	200Ω	20 uv
100	10	200Ω	20 uv
100	100	2000Ω	200uv
1000	100	2000Ω	200uv
1000	1000	20,000Ω	2.0 mv

Figure 4-3. CONTROL SETTINGS, LOAD REQUIREMENTS, AND LIMITS FOR LINE REGULATION

RANGE	READOUT	LOAD(50 ma)	SPEC.
10	1	20Ω	10 uv
10	10	200Ω	20 uv
100	10	200Ω	20 uv
100	100	2000Ω	200 uv
1000	100	2000Ω	200 uv
1000	1000	20,000Ω	2.0 mv

Figure 4-4. CONTROL SETTINGS, LOAD REQUIREMENTS, AND LIMITS FOR LOAD REGULATION

- g. Set the readout dials to 100 volts. The ripple output should not exceed 30 microvolts ins.
- h. Connect the 2,000-ohm load resistor to the OUTPUT terminals. The ripple output should not exceed 30 microvolts ms. Disconnect the load resistor.
- i. Set the readout dials to zero, and set the RANGE switch to 1000. The ripple output should not exceed 40 microvolts rms.
- J. Set the readout dials to 400 volts. The ripple output should not exceed 40 microvolts rms.
- k. Connect the 8,000-ohm load resistor to the OUTPUT terminals. The ripple output should not exceed 40 microvolts rms. Disconnect the load resistor.

**4-31. Voltage Standard Accuracy.** If the voltage standard has successfully passed the line, load, and ripple specifications, it can be assumed to be operating correctly. The output voltage can now be checked and compared to the specifications. These checks should be accomplished after the unit has warmed up for 1 hour at standard reference conditions of 23°C + 10, up to 70% relative humidity, and constant line voltage. One method of checking the instrument accuracy is by comparing the output voltages to a saturated standard cell by means of a reference divider. Use the equipment and connections shown in Figure 4-13 and the procedure of paragraph 4-53, disregarding the adjustments.

#### 4-32. Meter and Protection Circuits

**4.33. V-I Monitor.** This procedure checks the output voltage and current monitor circuitry associated with the front panel meter.

- a. With the METER switch in the VOLTAGE position, set the RANGE switch and readout dials for 100 volts output.
- b. The front panel meter should indicate 100 volts +3.0 volts.
- c. Check the meter linearity at the following cardinal points, Figure 4.5. All meter indications should be within +3% of full scale.
- d. Set the RANGE switch to 10 volts, the readout dials to 5 volts, the CURRENT LIMIT control maximum clockwise, and the METER switch to CURRENT.

RANGE	READOUT
10	1.000000
100	10.00000
1000	100.0000
10	10.000000
1000	1000.0000

Figure 4-5. CONTROL SETTINGS FOR V-I MONITOR TEST

- e. Connect a 0 to 100 dc milliammeter across the OUTPUT terminals.
- f. Rotate the CURRENT LIMIT control counter-clock-wise until the external meter indicates 50 milliamperes. The front panel meter of the Model 332D should indicate 50 milliamperes on the red cab.
- g. Set the RANGE switch to 100 volts, then to 1000 volts. The front panel meter should indicate 50 milliamperes in each position of the RANGE switch.

**4-34. Current Limit.** This check determines the range of the CURRENT LIMIT control, which should be from 2 to 60 milliamperes.

- a. Set the POWER switch to STDBY/RESET, the RANGE switch to 10 volts, the readout dials to 5 volts, and the CURRENT LIMIT control maximum clockwise.
- b. Connect a 0 to 100 dc milliammeter across the output terminals.
- c. Set the POWER switch to OPR. The external meter should indicate 60 milliamperes.
- d. Rotate the CURRENT LIMIT control maximum counter-clockwise. The external meter should indicate 2 milliamperes.

**4-35. Voltage Trip.** This test determines if the trip circuit will actuate during an overvoltage condition on each RANGE setting.

- a. Set the TRIP VERNIER maximum clockwise. Set the RANGE VOLTAGE TRIP, and readout dials to the values indicated in Figure 46. In each am.

rotate the VERNIER counterclockwise from the maximum clockwise position until the trip circuitry just actuates. In each case the VERNIER control should be approximately 300 from the maximum clockwise position.

RANGE	VOLTAGE TRIP	READOUT DIALS
10	10	10.X00000
100	100	10X.00000
1000	1000	10XX.X00

Figure 4-6. CONTROL SETTINGS FOR VOLTAGE TRIP CHECK

- Set the output of the instrument for 4 volts on the 10 volt range. Set the VOLTAGE TRIP switch to the 10 volt position and the VERNIER control to the 12 o'clock position.
- Set the RANGE switch to 100 volts. The trip circuit should actuate.
- Set the VOLTAGE TRIP switch to the 100 volt position and reset the instrument.
- Set the RANGE switch to the 1000 volt position. The trip circuit should actuate.
- Set the VOLTAGE TRIP switch to the 1000 volt position and the VERNIER maximum clockwise. Re-set the instrument.
- Set the RANGE switch to 100 volts then to 10 volts. The trip circuit should not actuate in either position.

#### 4-36. CALIBRATION

##### 4-37. Introduction

4-38. The following procedures are intended for calibration. The equipment required is listed in Figure 4-2. During the first portion of the calibration procedure, the chassis as will have to be removed from the case and the top inner cove removed from the chassis. However, upon removal of the top inner cover it will be necessary to "cheat" the interlock located at the top right-hand edge of the instrument

##### 4-39. Meter Mechanical Zero

4-40. With the instrument de-energized for at least 3 minutes, adjust the mechanical zero screw (located just below the front-panel meter so that the meter pointer b over the center scale zero position.

#### 4-41. Auxiliary Power Supply, Monitor Circuits and Meter Reference

**4-42. Auxiliary Power Supply.** With the POWER switch in the OFF position, connect the instrument through an autotransformer to the power line. Adjust the autotransformer for nominal line voltage. Extend the Auxiliary Power Supply P/C Assembly (A5A5) on the extender card provided. Set the POWER switch to the STDBY/RESET position. Allow approximately 10 minutes for warm-up; then proceed as follows:

- Using the +SENSE terminal s common, connect a Model 885A to pin 10 on the Auxiliary Power Supply P/C Assembly.
- Referring to Figure 4-7, adjust R9 until the Model 885A indicates 25 volts,  $\pm 10$  millivolts
- While varying the line voltage from 100 to 130 volts ac, the Model 885A indication should not change more than 20 millivolts.
- Set the POWER switch on OFF and disconnect the Model 885A. Replace the Auxiliary Power Supply P/C Assembly. Return the POWER switch to the STDBY/RESET position.

**4-43. Current Limit.** Proceed as follows:

- Set the front panel controls follows:

POWER	STDBY/RESET
RANGE	10
Readout Dials	5.000000
VOLTAGE TRIP	1000
VERNIER	maximum clockwise
CURRENT LIMIT	maximum clockwise

- Connect a 0 to 100 dc milliammeter across the OUTPUT terminals. Set the POWER switch to OPR.
- Referring to Figure 4-7, adjust R23 for a 60 millampere indication on the external meter.
- Rotate the CURRENT LIMIT control maximum counterclockwise. Referring to Figure 4-7, adjust R24 for a 2 millampere indication on the external meter.
- If necessary, readjust R23 and R24 until the e r of the CURRENT LIMIT control is from 2 to 60 millampere.

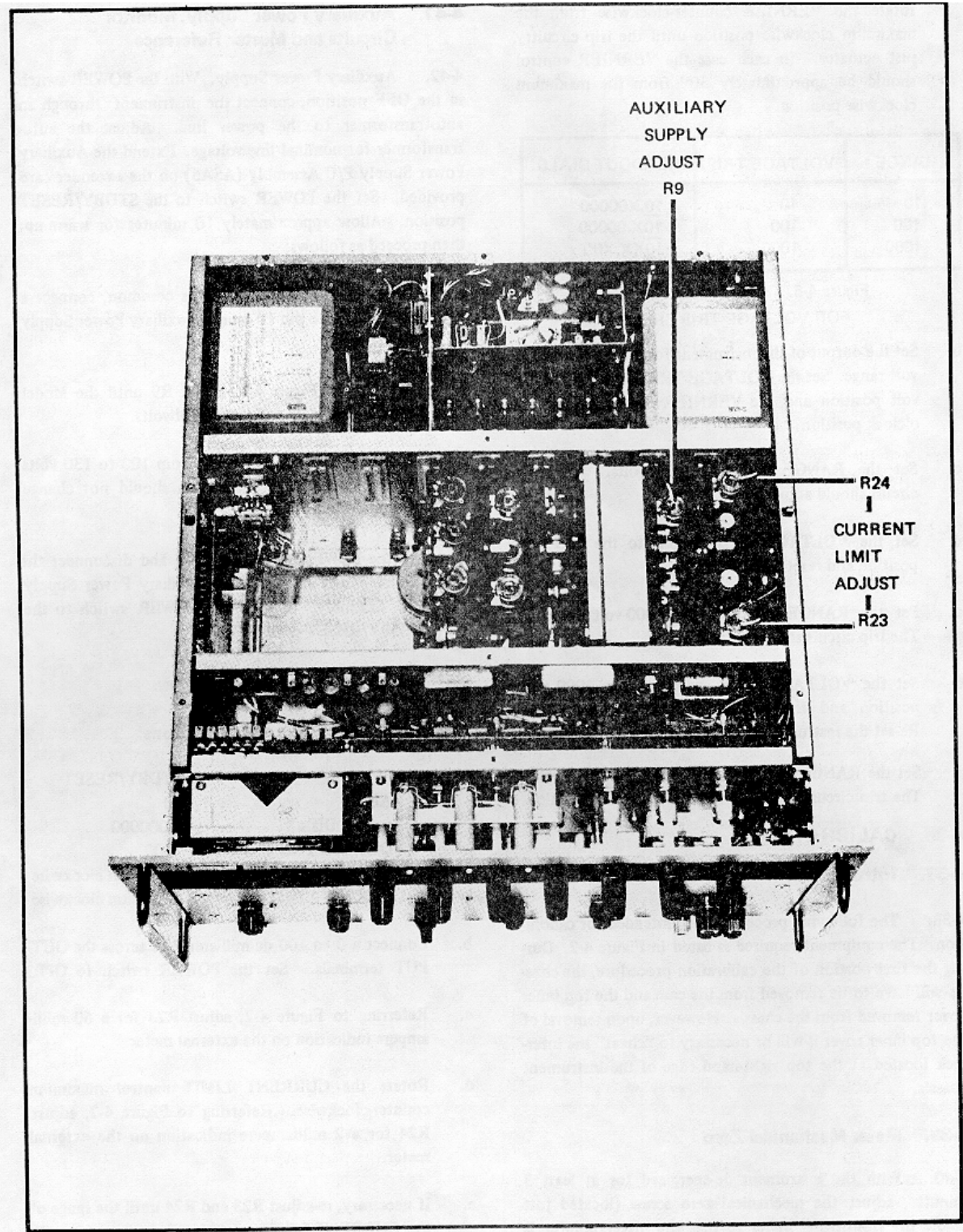

Figure 4-7. LOCATION OF ADJUSTMENTS

- f. Set the POWER switch to STDBY/RESET and install the top inner cover.

**4-44. Output Current Monitor. Proceed as follows:**

- a. Set the METER switch to CURRENT.
- b. Adjust the CURRENT LIMIT control to obtain a 50 millampere indication on the external meter.
- c. Rotate the adjustment labeled OUTPUT CURRENT METER ADJUST until the front-panel meter pointer indicates 50 milliamperes on the red scale.
- d. Set the RANGE switch to 100 volts; then to 1000 volts. The front-panel meter should indicate 50 milliamperes in each position of the RANGE switch.
- e. Set the POWER switch to STDBY/RESET and remove the external meter connections.

**4-45. Output Voltage Monitor. Proceed as follows:**

- a. Set the front panel controls as follows:
 

METER	VOLTAGE
RANGE	100
Readout Dials	100.00000
- b. Rotate the adjustment labeled OUTPUT VOLTMETER ADJUST until the front-panel meter indicates 100 volts  $\pm 0.5$  volts.
- c. Meter linearity may be checked at the cardinal points listed in Figure 4-8. All meter indications should be within +3% of full scale.

RANGE	READOUT DIALS
10	1.000000
100	10.00000
1000	100.0000
10	<u>10.000000</u>
1000	<u>1000.0000</u>

Figure 4-8. CONTROL SETTINGS FOR VOLTAGE MONITOR LINEARITY CHECK

**4-46. VOLTAGE TRIP. Proceed as follows:**

- a. Set the front panel controls as follows:
 

RANGE	100
Readout Dials	100X.00000
VOLTAGE TRIP	maximum counter-clockwise
VOLTAGE TRIP ADJUST (top cover)	clockwise
VOLTAGE TRIP	100
VERNIER	300 from maximum
- b. Rotate the VOLTAGE TRIP ADJUST until the output is de-energized, as indicated by the illumination of the red indicator lamp and the audible "click" of relays.
- c. Set the POWER switch to STDBY/RESET. Rotate the VERNIER control to the maximum clockwise position.
- d. Set the POWER switch to OPR. Set the RANGE switch, TRIP switch, and readout dials as listed in Figure 4-9. Check the trip action on each range by rotating the VERNIER control counterclockwise. The trip point should occur in each RANGE switch position when the VERNIER control is approximately 300 from the maximum clockwise position.

TRIP	RANGE	READOUT DIALS
10	10	<u>10.X00000</u>
1000	1000	<u>10XX.X000</u>

Figure 4-9. CONTROL SETTINGS FOR TRIP RANGE CHECK

**4-47. Master Reference. Proceed as follows:**

- a. Set the front panel controls as follows:
 

POWER	ON
RANGE	1000
Readout Dials	00X.0000
VOLTAGE TRIP	1000
VERNIER	Maximum clockwise
CURRENT LIMIT	Maximum clockwise
- b. Connect a Model 885A to the MASTER REFERENCE test points through the top inner cover.

- c. Adjust CAL 1000, CAL 100 and CAL 10 mechanically to mid-point of travel.
- d. Rotate the MASTER REFERENCE adjustment to obtain an indication of 6.02 volts (10 uv) on the Model 885A.
- e. Set the POWER switch to STDBY/RESET.

#### 4-48. Voltage Standard Output

4-49. The voltage standard is calibrated by setting the zero output and adjusting the sample string resistors and the range resistors. Adjustment of sample string resistors determines output voltage ratio accuracy and adjustment of the range resistors determines absolute voltage accuracy. The line linearization adjustment involves adjusting corresponding resistors in adjacent decades so they are in exact ten-to-one ratio of each other.

4-50. The instrument should be warmed up for at least four hours at standard reference conditions of  $230 \pm 1^\circ\text{C}$ , up to 70% relative humidity and constant line voltage before adjustments are made. The instrument must be operated in its case with the RANGE switch and readout dials set for 100 volts output.

**4-51. Zero Output Adjustments.** Proceed as follows:

- a. Slide the instrument chassis out of the case just far enough to reach the ZERO OUTPUT adjustment holes (10, 100V, V, 000V) in the cover.
- b. Connect a Model 885A differential voltmeter or a Model 845AR null detector across the OUTPUT terminals. Set the voltage standard dial readout to all zeros and the POWER switch to OPR.
- c. At each RANGE, switch position, vary the corresponding ZERO OUTPUT ADJUST (10V, 100V, 1000V) for a null indication (11 microvolt) on the voltmeter.
- d. Slide the chassis back into the case and re-check the zero output adjustments. Refine the adjustments if necessary.

4-52. Sample String Linearization. The following procedure describes linearization. The stable reference source in this procedure is a standard cell. To linearize, perform the following steps:

- a. Self-calibrate the Model 720A using the procedure contained in its Instruction Manual.
- b. Make the equipment connections illustrated in Figure 4-10
- c. Slide the instrument out of its case just far enough to gain access to the SAMPLE STRING ADJUST (DECK A AND B) access holes.

Maintenance access instructions are contained in paragraph 4-7.

- d. Set the front panel controls to the following positions: Meter Controls Voltage Monitor.

VOLTAGE TRIP	100
VERNIER	Midrange
CURRENT LIMIT	Midrange
RANGE	1000
Voltage Dials	00X.0000
POWER	OPR

- e. Set the Model 720A dials to 1/10 the value of the standard cell.
- f. Set the Model 845AR ZERO/OPR control to OPR, and adjust the Model 720A dials for a null indication on the Model 845AR 10 microvolt range. Record the exact null detector indication.

#### CAUTION!

**To prevent abusing the standard cell, set the Model 845AR ZERO/OPR control to ZERO when changing the Model 720A dial settings. Null adjustments should be performed initially at reduced null detector sensitivity. Increase the null detector sensitivity as the final null is approached.**

- g. Set the Model 845AR ZERO/OPR control to ZERO and the voltage dials to 010.000.
- h. Set the Model 845AR ZERO/OPR control to OPR and adjust the DECK B adjustment I for the null detector indication recorded in step f.
- i. Perform the DECK B adjustments contained in Figure 4-11 steps c through 1, observing flagnotes 1 and 2 which set limits for setting of decades six and seven.
- j. Set the RANGE switch to 100 and perform the DECK A adjustments of Figure 4-12.

**4-53. Range Calibration.** Proceed as follows:

- a. Connect the equipment as shown in Figure 4-13. Use low-thermal (copper) leads with spade lugs; the leads should be as short as possible.
- b. Connect the OUTPUT and the SENSE terminals together and connect the OUTPUT terminals to the OUTPUT terminals on the Model 750A. Connect the GUARD terminal to the shield of the output cable.
- c. Set the front panel controls as follows:

METER	VOLTAGE
RANGE	1000
TRIP	1000



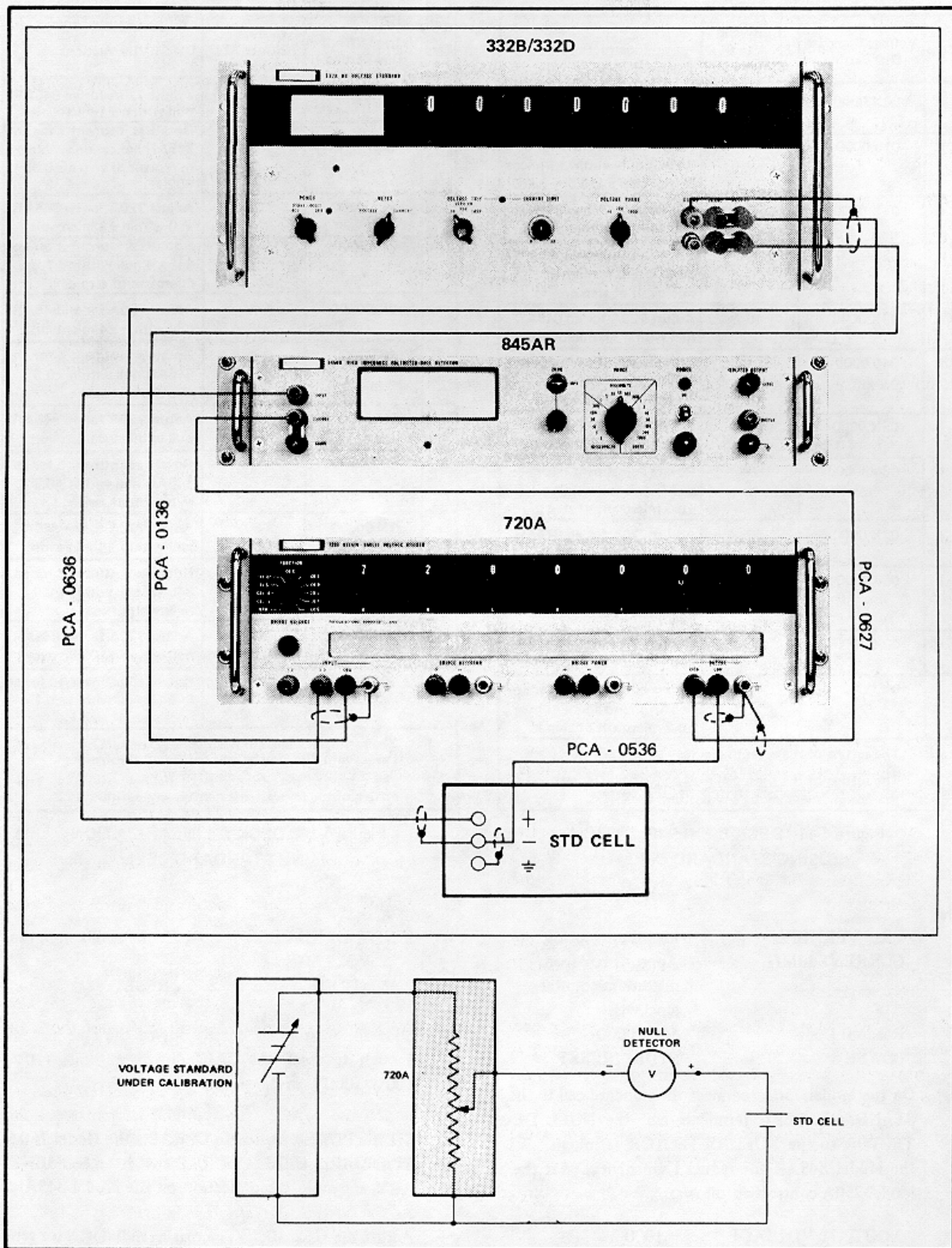

Figure 4-10. CONNECTIONS FOR SAMPLE STRING LINEARIZATION USING STANDARD CELL





Step	Voltage Standard Dial Setting	Initly. Set 720A to STD Divided By	Instructions
a.	00X.0000	10	Adjust 720A for an 845AR null within $\pm 1$ microvolt.
b.	010.0000	---	Rotate adjustment 1 for an 845AR null within $\pm 1$ microvolt of step a ( $\pm 0.5\mu\text{v}$ 332D)
c.	01X.0000 	20	Adjust 720A for an 845AR null within $\pm 2$ microvolt.
d.	020.0000	---	Rotate adjustment 2 for an 845AR null within $\pm 1$ microvolt of step c.
e.	03X.0000 	40	Adjust 720A for an 845AR null within $\pm 4$ microvolt.
f.	040.0000	---	Rotate adjustment 4 for an 845AR null within 0.5 microvolt of step e.
g.	05X.0000 	60	Adjust 720A for an 845AR null within $\pm 6$ microvolt.
h.	060.0000	---	Rotate adjustment 6 for an 845AR null within $\pm 0.3$ microvolt of step g.
i.	07X.0000 	80	Adjust 720A for an 845AR null within $\pm 8$ microvolt.
j.	080.0000	---	Rotate adjustment 8 for an 845AR null within $\pm 0.2$ microvolt of step i.
k.	09X.0000 	100	Adjust 720A for an 845AR null within $\pm 10$ microvolt.
l.	0X.0000	---	Rotate adjustment X for an 845AR indication within $\pm 0.2$ microvolt of step k.
<p>1 The setting of the seventh dial may be any position 0 - X.</p> <p>2 The setting of the sixth dial may be 0 or 1. The setting of the seventh dial may be any position 0 - X.</p>			

Figure 4-11. DECK B LINEARIZATION USING STANDARD CELL

TRIP VERNIER            Maximum clockwise  
CURRENT LIMIT        Approx. 100 from  
                                 maximum counter-  
                                 clockwise  
Readout Dials         1000.0000  
POWER                 STDBY/RESET

- d. On the Model 750A, connect the standard cell to the STANDARD CELL terminals and the NULL DETECTOR to the NULL DETECTOR terminals. Set the Model 845AR for reduced sensitivity. Set the Model 750A controls as follows:

OUTPUT VOLTAGE      1000  
STANDARD CELL        OPEN  
CIRCUIT





Step	Voltage Standard Dial Setting	Initly. Set 720A to STD Divided By	Instructions
a.	0X.00000	10	Adjust 720A for an 845AR null within $\pm 1$ microvolt.
b.	10.00000	---	Rotate adjustment 1 for an 845AR indication within $\pm 1$ microvolt of step a ( $\pm 0.5\mu\text{v}$ 332D)
c.	1X.00000	20	Adjust 720A for an 845AR null within $\pm 2$ microvolt.
d.	20.00000	---	Rotate adjustment 2 for an 845AR null within $\pm 1$ microvolt of step c.
e.	3X.00000 	40	Adjust 720A for an 845AR null within $\pm 4$ microvolt.
f.	40.00000	---	Rotate adjustment 4 for an 845AR null within $\pm 0.5$ microvolt of step e.
g.	5X.00000 	60	Adjust 720A for an 845AR null within $\pm 6$ microvolt.
h.	60.00000	---	Rotate adjustment 6 for an 845AR null within $\pm 0.3$ microvolt of step g.
i.	7X.00000 	80	Adjust 720A for an 845AR null within $\pm 8$ microvolt.
j.	80.00000	---	Rotate adjustment 8 for an 845AR null within $\pm 0.2$ microvolt of step i.
k.	9X.00000 	100	Adjust 720A for an 845AR null within $\pm 10$ microvolt.
l.	100.00000	---	Rotate adjustment 10 for an 845AR null within $\pm 0.1$ microvolt of step k.
<p>1 The setting of the sixth dial may be 0 or 1. The setting of the seventh dial may be any position 0 through X.</p> <p>2 The setting of the fifth and sixth dial may be 0 or 1. The setting of the seventh dial may be any position 0 - X.</p>			

Figure 4-12. DECK A LINEARIZATION USING STANDARD CELL

STANDARD CELL        Voltage of cell in use  
VOLTAGE  
INPUT VOLTAGE        RESET

- e. Slide the instrument chassis out of the case just far enough to reach the CAL adjustment holes (10V, 100V, 1000V) in the top cover.
- f. Set the POWER switch to OPR. Set the Model 750A STANDARD CELL CIRCUIT switch to MOMENTARY and note the deflection on the Model 845AR.
- g. Adjust the CAL 1000V, increasing null detector sensitivity until zero volts ( 1.0 microvolt) indication b obtained on the Model 845AR.

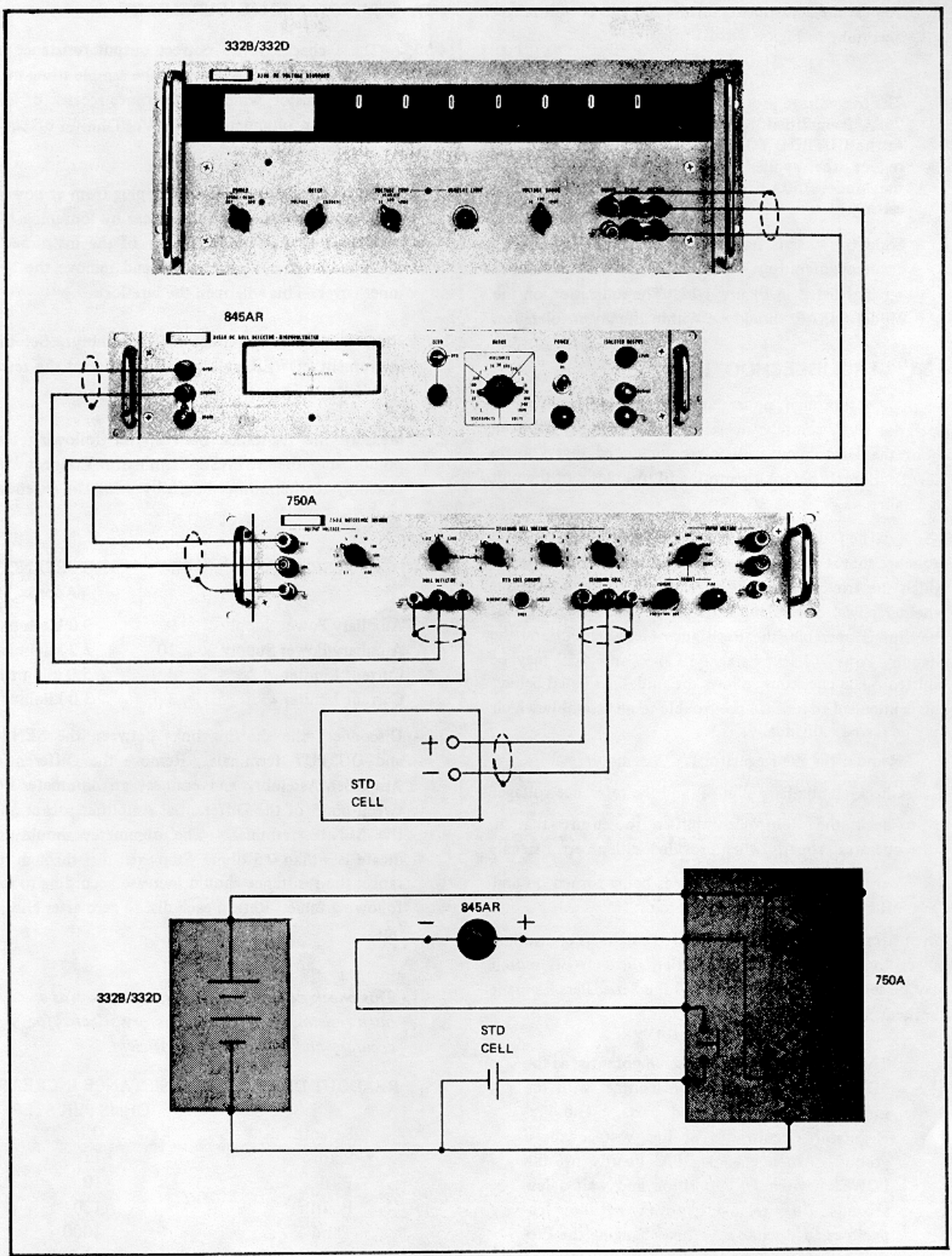

Figure 4-13. CONNECTIONS FOR RANGE CALIBRATION

- h. Repeat the adjustments for the 100 and 10 volt ranges according to Figure 4-14.

#### CAUTION!

**The overvoltage protection feature of the Model 750A is nullified when the voltage is applied to the OUTPUT VOLTAGE terminals. Always reduce the applied voltage before reducing the Model 750A OUTPUT VOLTAGE switch setting.**

- i. Slide the chassis back into the case and check the accuracy of output at the RANGE and dial readout settings listed in Figure 4-14. The indication on the Model 845AR should be within the given tolerance.

#### 4-54. TROUBLESHOOTING

4-55. A thorough understanding of the principles of operation is absolutely necessary to efficiently troubleshoot the instrument. It is recommended that you review Section II before attempting to troubleshoot the unit in detail.

4-56. The following troubleshooting procedure is in such sequence that it can be applied to any unit, including one in which the trouble is totally unknown and there is doubt whether power can be applied without causing damage. If the unit is operable, the Resistance Measurement and the Standby Power Check, Paragraphs 4-57 and 4-59 may be omitted. The checkout follows the guidelines listed below, and is intended to localize the trouble to an assembly which may be tested individually.

- Remove the Pre-Regulator P/C Assembly.
- Check all auxiliary supplies and the reference voltage.
- Check the Control Amplifier to ensure that it operates properly when provided with an error signal.
- Verify that the Pre-Regulator is being turned on and off by the Unijunction Oscillator. When it can be verified that the Pre-Regulator is controlling power to the High Voltage Rectifier, the POWER switch may be set to the OPR position and the Series Pass Element checked.

#### WARNING

**The inner chassis is at the same potential as the +OUTPUT terminal. Avoid contact with the inner chassis and exposed parts. The Pre-Regulator circuitry is at line voltage above ground. When changing P/C boards, use the POWER switch OFF position and wait a few seconds after removing power to allow capacitors to discharge. When changing the Pre-Regulator**

**Assembly, set the POWER switch to OFF.**

#### 4-57. RESISTANCE MEASUREMENTS

4-58. These checks verify correct output resistance of auxiliary voltage supplies. A check of the sample string ray' reveal an open resistor, which is sometimes a cause of loss of regulation. An ohmmeter (RCA VoltOhmyst or equivalent) is required for this test.

- Disconnect the instrument power plug from ac power. Disengage the chassis from the case by loosening the two Dzus fasteners on the rear of the instrument. Slide the unit out of the case and remove the top inner cover. This will open the interlock.
- Remove the Pre-Regulator P/C Assembly. Set the instrument POWER switch to OFF and set the readout dials to all zeros.
- Measure the resistance between the following test points and the +SENSE terminal. Connect the assembly to the mother board by using the extender card.

ASSEMBLY	PIN	RESISTANCE (Approx.)
Auxiliary Power Supply	9	9.0 kilohms
Auxiliary Power Supply	10	2.2 kilohms
Current Limiter	1	5.0 kilohms
Current Limiter	3	3.0 kilohms

- Disconnect the shorting links between the SENSE and OUTPUT terminals. Remove the Differential Amplifier Assembly and connect an ohmmeter between pin 5 of the Differential Amplifier socket and the SENSE terminal. The ohmmeter should indicate less than 0.5 ohm. Step each dial through its range; the resistance should increase according to the following table. Return each dial to zero after checkout.

#### NOTE

**This check detects gross errors only, such as an open resistor. Resistors are factory selected for accuracy and temperature coefficient.**

READOUT DIAL	RESISTANCE INCREASE OHMS PER STEP
Seventh	0.1
Sixth	1.0
Fifth	10
Fourth	100
Third	1000
Second	10,000
First	100,000

	MODEL 332B/332D			MODEL 750A	MODEL 845A	
	RANGE	READOUT	ADJUSTMENT	OUTPUT	TOLERANCE ( $\mu$ v)	
Adjustments	1000	1000.0000	CAL 1000V	1000	332B $\pm 1.0$	332D $\pm 0.5$
	100	100.00000	CAL 100V	100	$\pm 1.0$	$\pm 0.5$
	10	10.000000	CAL 10V	10	$\pm 1.0$	$\pm 0.5$
Checks	10	5.000000	.....	5	$\pm 5.0$	
	10	10.000000	.....	10	$\pm 5.0$	
	100	05.00000	.....	5	$\pm 5.0$	
	100	10.000000	.....	10	$\pm 5.0$	
	100	50.00000	.....	50	$\pm 5.0$	
	100	100.00000	.....	100	$\pm 5.0$	
	1000	005.0000	.....	5	$\pm 10.0$	
	1000	010.0000	.....	10	$\pm 5.0$	
	1000	050.0000	.....	50	$\pm 5.0$	
	1000	100.0000	.....	100	$\pm 5.0$	
	1000	500.0000	.....	500	$\pm 5.0$	
	1000	1000.0000	.....	1000	$\pm 5.0$	
	1000	1000.0000	.....	1100	$\pm 5.0$	

Figure 4-14. CONTROL SETTINGS AND TOLERANCES FOR RANGE CALIBRATION

- e. Reconnect the links between the SENSE and OUTPUT terminals and replace the Differential Amplifier Assembly.

- c. Set the POWER switch to STDBY/RESET and slowly increase the output of the Variac to 115 volts. The CURRENT LIMIT and center decimal lights should come on and the time delay relay (A6-K2001) should operate. The wattmeter should indicate 30 to 40 watts power drain.

#### 4-59. Standby Power

4-60. This check measures power consumption in the STDBY/RESET mode. It reveals possible gross faults such as wiring errors or shorted components in the auxiliary power supply, voltage control circuitry and protection circuitry. A metered Variac and differential voltmeter are required for this test.

- Remove the top inner cover and the Pre-Regulator Assembly if not already accomplished.
- Connect the instrument through a Variac to a 115 volt, 60 Hz, power line with a wattmeter or ammeter in series between the Variac and the instrument. Set the Variac output to zero. Set the front panel control as follows:

POWER	OFF
VOLTAGE RANGE	100
VOLTAGE TRIP	1000
VERNIER	maximum clockwise
CURRENT LIMIT	maximum clockwise
Readout Dials	50.00000



#### 4-61. Auxiliary Supply Voltages

4-62. This procedure checks out the bias voltages, master reference voltage and the series pass element voltage.

- Using the Model 885A differential voltmeter, measure the voltage between the test points listed in Figure 4-15 and the +SENSE terminal, which is common.
- Where indicated, perform the adjustment to determine that it can be made. These should be re-checked during calibration of the instrument.

#### 4-63. Unijunction Oscillator and Control Amplifier

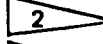
4-64. This check verifies operation of the unijunction oscillator and the flow of error signal through the chopper amplifier, differential amplifier and series pass drive. An oscilloscope and a general-purpose power supply are required for this test.

ASSEMBLY	PIN	VOLTS DC
Auxiliary Power Supply	10	23 to 27 
Auxiliary Power Supply	9	-14 to -16
Current Limiter	1	-33 to -39
Current Limiter	3	33 to 39
Reference Calibration	Test Points	5.9 to 6.1 
Master Reference	Collector Q1	26 to 35 
Series Pass	Collector Q8	Approx. 140
Rear bulkhead power resistor, 100 kilohms	Yellow lead	650



	Adjustable to 25 volts $\pm$ 10 mv with R9
	Adjustable to 6.02 volts $\pm$ 10 uv with R2
	Approximately 1 volt at turn-on, rising to 26 to 35 volts after 10 minute warm up.

Figure 4-15. REFERENCE AND AUXILIARY VOLTAGES

- a. Connect the oscilloscope with a 10X isolation probe between pins 14 (common) and 15 (input) of the Series Pass P/C Assembly. Set the oscilloscope sweep speed to 2 milliseconds/cm and vertical sensitivity to 50 millivolts/cm.
- b. Set the POWER switch to STDBY/RESET. Positive going pulses of 0.7 to 2.5 volts peak-to-peak should be observed.
- c. Set the POWER switch to ON. The pulses should disappear.
- d. Connect a general purpose power supply, set for 5.5 volts output, to the OUTPUT terminals: positive to positive and negative to negative.
- e. Set the RANGE switch to 10 and the readout dials to 5.000000: unijunction pulses should appear on the oscilloscope. Set the readout dials to 6.000000; the unijunction pulses should disappear. These results correct control amplifier operation.
- f. To check out the additional RANGE switch circuitry, set the RANGE and readout dials as follows:

RANGE	READOUT DIALS	UNIUNCTION PULSES
100	05.00000	should appear
100	06.00000	should disappear
1000	005.0000	should appear
1000	006.0000	should disappear

**4-65. Pre-Regulator**

4-66. This check verifies operation of the Pre-Regulator circuitry Q1 through Q8. An oscilloscope and a power line isolation adapter are required for this test.

- a. Set the POWER switch to OFF. Install the Pre-Regulator P/C Assembly.
- b. Set the instrument front panel controls as follows:

POWER	OFF
RANGE	1000
VOLTAGE TRIP	1000
VERNIER	maximum clockwise
CURRENT LIMIT	maximum clockwise
- c. Connect the oscilloscope power plug to the ac line via a line isolator (two-to-three wire adapter). The oscilloscope must be operated ungrounded when observing pre-regulator waveforms.
- d. Connect the oscilloscope common to the emitter (blue) of Q1 and connect the input to the base (yellow). (Q1 is the stud-mounted power transistor.) Set the vertical input to DC, sweep speed to 2 millisecond/cm and the vertical sensitivity to 1.0 volt/cm.
- e. Set the POWER switch to STDBY/RESET. The oscilloscope waveform should appear as shown in Figure 4-16.

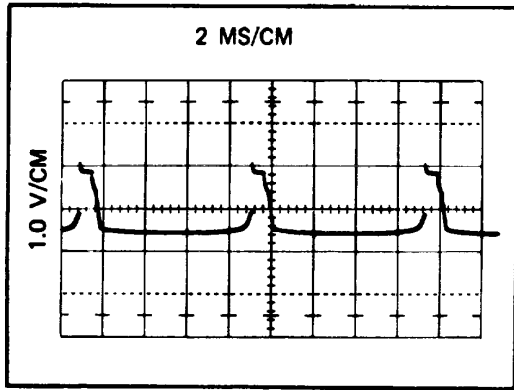

Figure 4-16. PRE-REGULATOR Q1, WAVEFORM ON STDBY/RESET

- f. Set the POWER switch to OPR. The waveform should appear as shown in Figure 4-17.

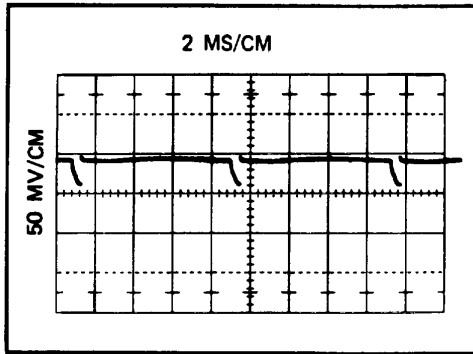

Figure 4-17. PRE-REGULATOR Q1, WAVEFORM ON OPR

**4-67. Series Pass Element**

If the procedure has been completed satisfactorily thus far, the main parts of the voltage control circuitry have been checked out excluding the Series Pass P/C Assembly. A simple check of the series pass function is to measure ac power consumption in OPR mode with 1000 volts dc output. A metered Variac, a differential voltmeter and a load resistor box are required for this test.

- a. Set the instrument front panel controls as follows:

METER	VOLTAGE
POWER	STDBY/RESET
RANGE	1000

VOLTAGE TRIP	1000
VERNIER	maximum clockwise
CURRENT LIMIT	maximum clockwise
Readout Dials	All zeros

- b. Close the interlock switches. Set the POWER switch to OPR and step the first voltage dial from 0 to 10. The wattmeter indication at 1000 volts output should be 60 to 70 watts. If the indication is 80 watts or greater, it is possible that the series pass function is faulty, assuming that any trouble in the pre-regulator was detected by the preceding check.
- c. The capability of the series pass element to regulate may be checked by measuring the voltage drop across the series pass transistors. Connect a dc high-impedance voltmeter between pins 11 (positive) and 5 (common). Set the RANGE switch to 10 and the readout dials to all zeros. Adjust the line voltage to 100 volts. The voltmeter indication should be less than 85 volts.
- d. Connect the voltmeter between the collector of Q8 and pin 5. Measure the voltage across Q8 at the following control settings and line voltages. The voltage should be within the given limits.

RANGE	READOUT DIALS	LINE VOLTAGE	VOLTAGE LIMITS ACROSS Q8	
			VOLTAGE MINIMUM	MAXIMUM
10	All zeros	100	70	100M
10	All zeros	130	65	100

- e. Set the POWER switch to STDBY/RESET and connect the Load Resistor Box, set for 183 kilohms (60 ma load), to the OUTPUT terminals. Set the POWER switch to OPR and measure the voltage across Q8 at the following control settings and line voltages.

RANGE	READOUT DIALS	LINE VOLTAGE	VOLTAGE LIMITS ACROSS Q8	
			VOLTAGE MINIMUM	MAXIMUM
1000	10x0.0000	100	40	55
1000	10x0.0000	130	40	55

- f. Set the POWER switch to STDBY/RESET and disconnect the Load Resistor Box. On the 1000 volt RANGE, set the readout dials for output voltages of 100, 500, and 1100. At each output connect a shorting jumper across the OUTPUT terminals. Observe the panel meter and remove the shorting jumper. The output should return to normal on removal of the short.
- g. If the voltage standard successfully passes the foregoing checks, the Performance Test should be performed to determine if any specification is out of tolerance.

#### 4-68. Preventive Maintenance Instructions

#### 4-69. Scope of Maintenance

4-70. The maintenance duties assigned to the operator and organizational repairman of this equipment are listed below with a reference to the paragraphs covering the specific maintenance functions. The preventive maintenance procedures require no special tools or test equipment.

- a. Daily preventive maintenance checks and services (paragraph 4-76).
- b. Weekly preventive maintenance checks and services (paragraph 4-77).
- c. Monthly preventive maintenance checks and services (paragraph 4-78).
- d. Quarterly preventive maintenance checks and services (paragraph 4-81).
- e. Cleaning (paragraph 4-84).
- f. Touchup painting instructions (paragraph 4-86).

#### 4-71. Materials Required for Maintenance

- a. *Trichloroethane* (Federal stock No. 6810-292-9625).

#### WARNING

The fumes of trichloroethane are toxic. Provide thorough ventilation whenever used. DO NOT use near an open flame. Trichloroethane is not flammable, but exposure of the fumes to an open flame converts the fumes to highly toxic, dangerous gases.

- b. *Cleaning cloth.*
- c. *Fine sandpaper.*
- d. *Touchup paint.*

#### 4-72. Preventive Maintenance

4-73. Preventive maintenance is the systematic care, servicing, and inspection of equipment to prevent the occurrence of trouble, to reduce downtime, and to assure that the equipment is serviceable.

a. *Systematic Care.* The procedure given in paragraphs 4-76 through 4-87 covers routine systematic care and cleaning essential to proper upkeep and operation of the equipment.

b. *Preventive Maintenance Checks and Services.* The maintenance checks and services charts outline functions to be performed at specific intervals. These checks and services are to maintain equipment in a combat serviceable condition; that is, in good general (physical) condition and in good operating condition. To assist operators in maintaining combat serviceability, the charts indicate what to check, and the normal conditions. The reference column lists the paragraphs that contain additional information. If the defect cannot be found by performing the corrective action indicated, higher category of maintenance or repair is required. Records and reports of these checks and services must be made in accordance with the requirements set forth in TM 38-750.

#### 4-74. Preventive Maintenance Checks and Services Periods

4-75. Preventive maintenance checks and services of this equipment are required daily, weekly, monthly, and quarterly. Daily maintenance checks and services are specified in paragraph 4-76. Paragraph 4-77 specifies checks and services that must be performed weekly. If the equipment is maintained in a standby condition, the daily and weekly checks should be accomplished at the same time. The maintenance checks and services that are accomplished monthly are specified in paragraph 4-78. Quarterly maintenance checks and services are specified in paragraph 4-81.

#### 4-76. Daily Preventive Maintenance Checks and Services Chart

<i>Sequence No.</i>	<i>Items to be Inspected</i>	<i>Procedure</i>	<i>Reference</i>
1	Completeness	See that the equipment is complete.	Appendix D
2	Cleanliness	Exterior of equipment must be clean and dry, free of fungus, dirt, dust, or grease.	Paragraph 4-84
3	Operational Check	Check the operational efficiency.	
4	Controls	See that controls operate smoothly and are fastened in place securely.	

#### 4-77. Weekly Preventive Maintenance and Services Charts

<i>Sequence No.</i>	<i>Items to be Inspected</i>	<i>Procedure</i>	<i>Reference</i>
1	Cables	Inspect cards and cables for chafed, cracked, or frayed insulation. Replace connectors that are broken, stripped, or worn.	
2	Metal surfaces	Inspect exposed metal surface for rust and corrosion. Clean and touch up with paint as required.	Paragraphs 4-84 and 4-86



**4-78. Monthly Maintenance**

services chart (paragraph 4-80) once each month. Periodic daily (paragraph 4-76) and weekly (paragraph 4-77) services constitute a part of the monthly checks.

**4-79.** Perform the maintenance functions indicated in the monthly preventive maintenance checks and

**4-80. Monthly Preventive Maintenance Checks and Services Chart**

<b>Sequence No.</b>	<b>Items to be Inspected</b>	<b>Procedure</b>
1	Terminations	Inspect for loose connections and cracked or broken insulation
2	Control Panel	Clean panel thoroughly and check all surfaces for chips, cracks, or abnormal wear.
3	Hardware	Inspect all hardware for possible damage.

**4-81. Quarterly Maintenance**

**4-82.** Quarterly preventive maintenance checks and services are required for this equipment. Periodic daily, weekly, and monthly services constitute a part of the quarterly preventive maintenance checks and services and must be performed concurrently. All deficiencies or shortcomings will be recorded in accordance with the

requirements of TM 38-750. Perform all the checks and services listed in the quarterly preventive maintenance checks and services chart (paragraph 4-83) in the sequence listed. Adjustment of the maintenance interval must be made to compensate for any unusual operating conditions.

**4-83. Quarterly Preventive Maintenance Checks and Services Chart**

<b>Sequence No.</b>	<b>Items to be Inspected</b>	<b>Procedure</b>	<b>Reference</b>
1	Publications	See that all publications are complete, serviceable, and current.	DA Pam 310-4
2	Modifications	Check DA Pam 310-7 to determine whether new applicable MWO's have been published. All URGENT MWO's must be applied immediately. All NORMAL MWO's must be scheduled.	TM 36-750 and DA Pam 310-7

**4-84. Cleaning**

**4-85. inspect the exterior surfaces.** The surfaces must be free of dust, dirt, grease, and fungus.

a. Remove dust and loose dirt with a clean, soft cloth.

b. Remove grease, fungus, and ground-in dirt. Use a damp cloth (not wet) with trichloroethane to clean terminations. If dirt on the body of the unit is difficult to remove, use mild soap and water.

c. Remove dust or dirt from the jacks and plugs with a brush.

**4-86. Touchup Painting Instructions**

**4-87.** Remove dust and corrosion from metal surfaces by lightly sanding them with fine sandpaper. Brush two thin coats of paint on the bare metal to protect it from further corrosion. Refer to applicable cleaning and refinishing practices specified in TB 746-10.

## Section 5

## List of Replaceable Parts

**5-1. INTRODUCTION**

5-2. This section contains complete descriptions of those parts one might normally expect to replace during the life of the instrument. The first listing is a breakdown of all of the major assemblies in the instrument. Subsequent listings itemize the components in each assembly. Every listing is accompanied by an illustration identifying each component in the listing. Assemblies and subassemblies are identified by a reference designation beginning with the letter A, (e. g. A1, etc.). Components are identified by the schematic diagram reference designation (e. g. R1, C107, DS1). Parts not appearing on the schematic diagram are numbered consecutively throughout the parts list with a whole number in arrow call-out illustrations and are identified by index number only in grid illustrations. Flagnotes are used throughout the parts list and refer to ordering explanations. The flagnote explanations appear at the end of the parts list in which they are listed.

**5-3. COLUMNAR INFORMATION**

- a. The REF DESIG column indexes the item description to the associated illustration. In general the reference designations are listed under each assembly in alpha-numeric order. Sub-assemblies of minor proportions are sometimes listed with the assembly of which they are a part. In this case, the reference designations for the components of the sub-assembly may appear out of order.
- b. The INDEX NO. column lists co-ordinates which locate the designated part on the associated illustrations.
- c. The DESCRIPTION column describes the salient characteristics of the component. Indention of the description indicates the relationship to other assemblies, components, etc. In many cases it is necessary to abbreviate in this column. For abbreviations and symbols used, see Appendix B.
- d. The ten-digit part number by which the item is identified at the John Fluke Mfg. Co. is listed in the STOCK NO. column. Use this number when ordering parts from the factory or authorized representatives.
- e. The Federal Supply Code for the item manufacturer is listed in the MFR column. An abbreviated list of Federal Supply Codes is included in the Appendix.
- f. The part number which uniquely identifies the item to the original manufacturer is listed in the MFR PART NO column. If a component must be ordered by description, the type number is listed.
- g. The TOT QTY column lists the total quantity of the item used in the instrument. Second and subsequent listing of the same item are referenced to the first listing with the abbreviation REF. In the case of optional sub-assemblies, plug ins, etc. that are not always part of the instrument, the TOT QTY column lists the total quantity of the item in that particular assembly.
- h. Entries in the REC QTY column indicate the recommended number of spare parts necessary to support one to five instruments for a period of two years. This list presumes an availability of common electronic

parts at the maintenance site. For maintenance for one year or more at an isolated site, it is recommended that at least one of every part in the instrument be stocked.

- i. The USE CODE column identifies certain parts which have been added, deleted or modified during the production of the instrument. Each part for which a Use Code has been assigned may be identified with a particular instrument serial number by consulting the Serial Number Effectivity List in paragraph 5-7. As Use Codes are added to the list, the TOT QTY column listings are changed to reflect the most current information. Sometimes when a part is changed, the new part can and should be used as a replacement for the original part. In this event a parenthetical note is added in the DESCRIPTION column.

**5-4. HOW TO OBTAIN PARTS**

5-5. Refer to page 16 of addenda above.

5-6. Deleted.

**5-7. SERIAL NUMBER EFFECTIVITY**

5-8. A Use Code column is provided to identify certain parts that have been added, deleted, or modified during production of the Model 332B/332D. Each part for which a use code has been assigned may be identified with a particular instrument serial number by consulting the Use Code Effectivity List below. All parts with no code are used on all instruments with serial numbers above 123.

USE CODE	EFFECTIVITY
None	Model 332B & 332D serial number 123 and on.
A	Model 332B serial number 123 thru 131, 136, 138,140, 141, 144, and 145.
B	Model 332B & 332D serial number 132 thru 135, 137, 139, 142, 143, and 146 and on.
C	Model 332B serial number 123 thru 147.
D	Model 332B serial number 148 thru 178.
E	Model 332B & 332D serial number 179 and on.
F	Model 332B serial number 123 thru 177.
G	Model 332B & 332D serial number 178 and on.
H	Model 332B serial number 123 thru 187.
I	Model 332B serial number 188 thru 307, 309, 311,314,316,317,319,320,322-324,330,331, 335.
J	Model 332B serial number 123 thru 207.
K	Model 332B & 332D serial number 208 and on.
L	Model 332B serial number 123 thru 365.
M	Model 332B & 332D serial number 366 and on.
N	Model 332B & 332D serial number 270, 273, 283, 284, 287 thru 296, 298,300 thru 302, 305, 306, and on.
O	Model 332B serial number 123 thru 305.
P	Model 332B & 332D serial number 306 and on.

USE CODE	EFFECTIVITY
Q	Model 332B serial number 123 thru 355.
R	Model 332B & 332D serial number 356 and on.
S	Model 332B serial number 123 thru 355, 357, 359 thru 367 and 370 thru 375.
T	Model 332B & 332D serial number 356, 358, 368, 369 and 376 and on.
U	Model 332B serial number 123 thru 415.
V	Model 332B & 332D serial number 416 and on.
W	Model 332B serial number 123 thru 465 and 471 and on.
X	Model 332B & 332D serial number 466 thru 470.

REF DESIG	INDEX NO	DESCRIPTION	STOCK NO	MFR	MFR PART NO	TOT QTY	REC QTY	USE CODE
		<b>DC VOLTAGE STANDARD</b> <b>Figure 5-1</b>	332B					
A1		Capacitor P/C Assembly (See Figure 5-2)	1702-239343 (332B-4055)	89536	1702-239343	1		
A2		Sample String P/C Assembly (See Figure 5-3)				1		
A3		Capacitor Switch P/C Assembly (See Figure 5-4)	1702-227603 (335A-4092)	89536	1702-227603	1		
A4		Reference Calibration P/C Assembly (See Figure 5-5)	1702-219113 (335A-4052)	89536	1702-219113	1		
A5		Main Mother Board P/C Assembly (See Figure 5-6)	1702-219238 (335A-4064)	89536	1702-219238	1		
A5A1		Master Voltage Reference P/C Assembly (See Figure 5-7)	1702-298653 (335A4101)	89536	1702-298653	1		
A5A2		Series Pass Driver P/C Assembly	1702-219154 (See Figure 5-8)	89536	1702-219154 (335A-4056)	1		
A5A3		Differential Amplifier P/C Assembly (See Figure 5-9)	1702-219162 (335A-4057)	89536	1702-219162	1		
A5A4		Chopper Amplifier P/C Assembly	1702-219170 (See Figure 5-10)	89536	1702-219170 (335A-4058)	1		
A5A5		Auxiliary Power Supply P/C Assembly (See Figure 5-11)	1702-219188 (335A-4059)	89536	1702-219188	1		
A5A6		Current Limiter P/C Assembly	1702-219196 (See Figure 5-12)	89536	1702-219196 (335A-4060)	1		
A6		Time Delay P/C Assembly (See Figure 5-13)	1702-192260 (332A-420)	89536	1702-192660	1		
A7		High Voltage Mother Board P/C Assembly (See Figure 5-14)	1702-239350 (332B-4056)	89536	1702-239350	1		
A7A1		Series Pass Element P/C Assembly (See Figure 5-15)	1702-219204 (335A-4061)	89536	1702-219204	1		
A7A2		Preregulator P/C Assembly	1702-222000 (See Figure 5-16)	89536	1702-222000 (335A-4082)	1		
A8		Extender P/C Board	1702-187344 (332A-415)	89536	1702-187344	1		
C1		Cap, oil, 4 uf $\pm$ 10%, 1,200v	1505-183541	01884	CMLE405K12	1		
C2		Cap, cer, 0.01 uf, grmv, 1,600v (located on C1)	1501-106930	71590	DD16-103	2		
C3		Cap, cer, 0.005 uf $\pm$ 20%, 3,000v	1501-188003	71590	DD30-502	1		
C4		Cap, plstc, 0.1 uf $\pm$ 10%, 1,500v	1507-234260	96733	C-60232A	2		

REF DESIG	INDEX NO	DESCRIPTION	STOCK NO	MFR	MFR PART NO	TOT QTY	REC QTY	USE CODE
C5		Cap, plstc. 0.1 uf $\pm 10\%$ , 1,500v	1507-234260	96733	C-60232A	REF		
C8		Cap, cer. 0.1 uf $\pm 80/-20\%$ , 500v	1507-105684	58289	41C92	2		
C7		Cap. cer. 0.1 uf $\pm 80/-20\%$ , 500v	1501-105884	56289	41C92	REF		
CR1		Diode, silicon, 1 amp, 100 piv	4802-116111	05277	1N4817	55	5	
CR2		Diode, silicon, 1 amp, 600 piv	4802-112383	05277	1N14822	48	5	
CR3		Diode, silicon, lamp, 600 piv	4802-112383	05277	1N4822	REF		
DS1		Lamp, incandescent, 28v	3901-175265	89730	757	5	5	
DS2		Lamp, incandescent, 28v	3901-175285	89730	757	REF		
DS3		Lamp, incandescent, 28v	3901-175285	89730	757	REF		
DS4		Lamp, incandescent, 28v	3901-175265	89730	757	REF		
DS5		Lamp, incandescent, 28v	3901-175285	89730	757	REF		
F1		Fuse, Type MDL, slow blow, 1/4 amp, 250v	5101-166308	71400	Type MDL	1	5	
F2		Fuse, Type MDA, slow blow, 3 amp, 250v (For 115v operation)	5101-109280	71400	Type MDA	1	5	
F2		Fuse, Type MDX, slow blow, 1-1/2 amp, 250v (For 230v operation)	5101-109231	71400	Type MDX	1	5	
J1		Binding post, red, OUTPUT	2811-149856	58474	BHB10208G22	2		
J2		Binding post, black, OUTPUT	2811-149864	58474	BHB10208G21	2		
J3		Binding post, red, SENSE	2811-149856	58474	BHB10208G22	REF		
J4		Binding post, black, SENSE	2811-149864	58474	BHB10208G21	REF		
J5		Binding post, GROUND	2811-155911	58474	GP30NC	1		
J6		Binding post, blue, GUARD	2811-233833	58474	DF31BLC	1		
K1		Relay, armature, 115 vac, dpdt	4504-196675	8953	4504-196675	1		J
K1		Relay, armature, 115 vac, dpdt	4504-148940	73949	A410-060713- 00	1		K
M1		Meter, 0-100 ua, 325 $\Omega$	2901-225490	89536	2901-225490	1		
R1		Res, met flm, 100k $\pm 1\%$ , 1/2w (mounted on S3)	4705-151316	75042	Type CEC-TO	2		
R2		Res, met flm, 1M $\pm 1\%$ , 1/2w (mounted on S3)	4705-161075	75042	Type CEC-TO	1		
R3		Res, car flm, 5M $\pm 1\%$ , 1w	4703-107458	75042	Type C13	2		
R4		Res, car flm, 5M $\pm 1\%$ , 1w	4703-107458	75042	Type C13	REF		

REF DESIG	INDEX NO	DESCRIPTION	STOCK NO	MFR	MFR PART NO	TOT QTY	REC QTY	USE CODE
R5		Res, var, ww, 5k $\pm$ 10%, 5w (mounted on S3)	4702-219758	71450	Type AW	1		
R6		Res, var. ww, 300 $\Omega$ $\pm$ 10%, 5w	4702-219741	71450	Type AW	1		
R7		Res, comp, 1k $\pm$ 10%, 1/2w	4704-108563	01121	EB1021	4		
R8		Res, ww, 500 $\Omega$ $\pm$ 5%, 25w	1706-183533	14193	Type MC250	1		
R9		Res, ww, 100k $\pm$ 1%, 10w	4706-177121	14193	Type SP1127	2		
R10		Res, ww, 100k $\pm$ 1%, 10w	4706-177121	14193	Type SP1127	REF		
S1		Switch, POWER, STDBY/RESET wafer	5107-187864	76854	Type HC	1		
		Switch, POWER, OPR wafer	5107-187872	76854	248214HC	1		
S2		Switch, VOLTAGE RANGE, rotary	5105-237305	89536	5105-237305	1		
S3		Switch, VOLTAGE TRIP, rotary	5105-240739	89536	5105-240739	1		
S4		Switch, METER, rotary	5105-187146	89536	5105-187146	1		
S5		Switch, interlock	5104-187708	91929	V3L-78	2		
S6		Switch, interlock	5104-187708	91929	V3L-78	REF		
T1		Transformer, power	5602-222315	89536	5602-222315	1		
T2		Transformer, high voltage	5602-222307	89536	5602-222307	1		
W1		Line cord	6005-102822	89536	6005-102822	1		
XDS1 thru XDS3		Holder, lamp	2110-100131	95263	7-14	3		
XDS4, XDS5		Holder, lamp	2110-103523	72619	7-08	2		
XF1, XF2		Holder, fuse	2102-160846	75915	342004	2		
1		Coupler, dial	3153-130252	89536	3153-130252	7		
2		Coupler, R5 to S3	2402-193557	89536	2402-193557	1		
3		Coupler, Digit Switches to detents	3153-226779	89536	3153-226779	7		
4		Coupler, Digit Switches, S1, S4, R6	2402-104505	89536	2402-104505	11		
5		Coupler, S3	3153-246058	89536	3153-246058	1		
6		Coupler, S1 shaft to S1 wafer	2402-200592	89536	2402-200592	1		
7		Cover (not illustrated)	1402-228809	89536	1402-228809	1		
8		Detent, S1	5108-240895	89536	5108-240895	1		
9		Detent, Digit Switches	5108-240887	89536	5108-240887	7		

REF DESIG	INDEX NO	DESCRIPTION	STOCK NO	MFR	MFR PART NO	TOT QTY	REC QTY	USE CODE
10		Dial, 0-10	2506-236984	89536	2506-236984	1		
11		Dial, 0-X	2506-236976	89536	2506-236976	6		
12		Foot, rubber (not illustrated)	2819-103309	77969	9102W	4		
19		Handle, chrome plated brass	2404-101717	05704	807	2		
14		Knob, CURRENT LIMIT	2405-190249	89536	2405-190249	1		
15		Knob, DIGITS 1-7	2405-158949	89536	2405-158949	7		
16		Knob, METER, POWER, VOLTAGE RANGE	2405-158956	89536	2405-158956	3		
17		Knob, VOLTAGE TRIP						
17a		Concentric	2405-162347	89536	2405-162347	1		
17b		vernier	2405-241018	89536	2405-241018	1		
17c		trim disc	2405-236950	89536	2405-236950	1		
18		Lens, decimal, clear	3155-222596	89536	3155-222596	3		
19		Lens, decimal, red	3155-228056	89536	3155-228056	2		
20		Link, shorting, copper	2811-190728	24655	938LG	2		
21		Panel, front	1406-228775	89536	1406-228775	1		
22		Shaft, S3 (not illustrated)	3103-227272	89536	3103-227272	1		
23		Shaft, S3 to front panel	3103-240879	89536	3103-240879	1		
24		Shaft, S1	3103-239392	89536	3103-239392	1		
25		Shaft, Digit Switches, S1, S4, R6	3103-226928	89536	3103-226928	10		



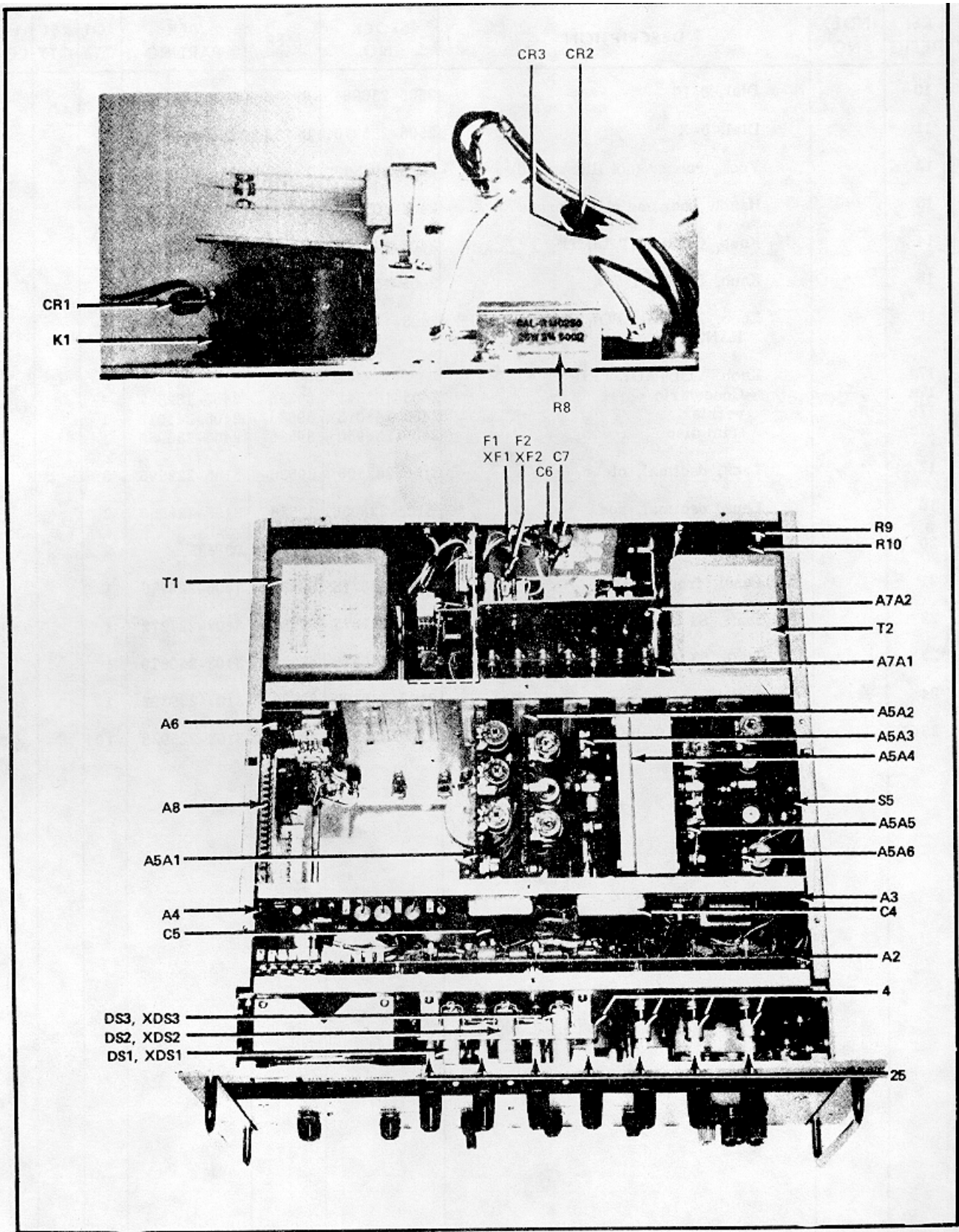

Figure 5-1. DC VOLTAGE STANDARD (Sheet 1 of 3)

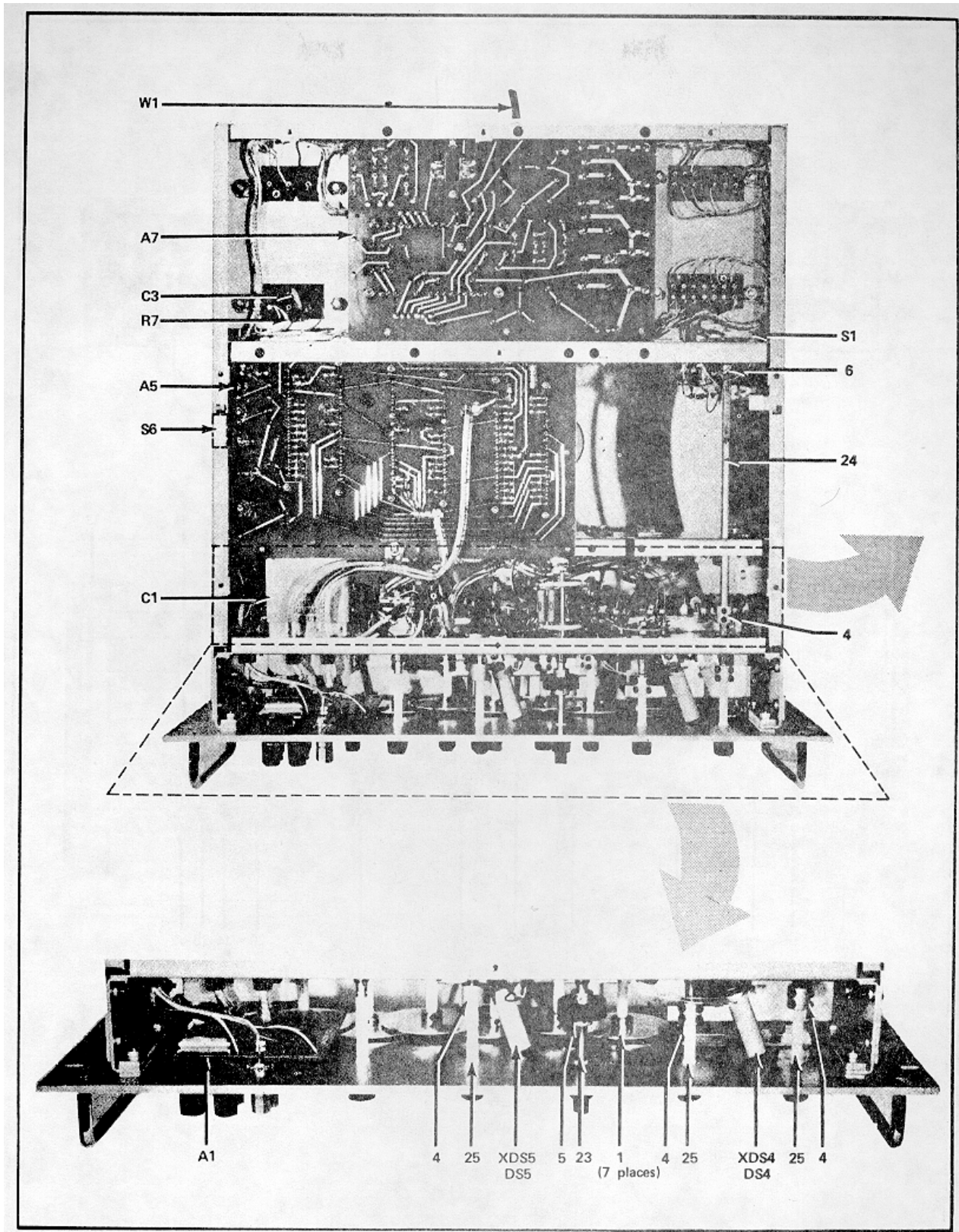

Figure 5-1. DC VOLTAGE STANDARD (Sheet 2 of 3)

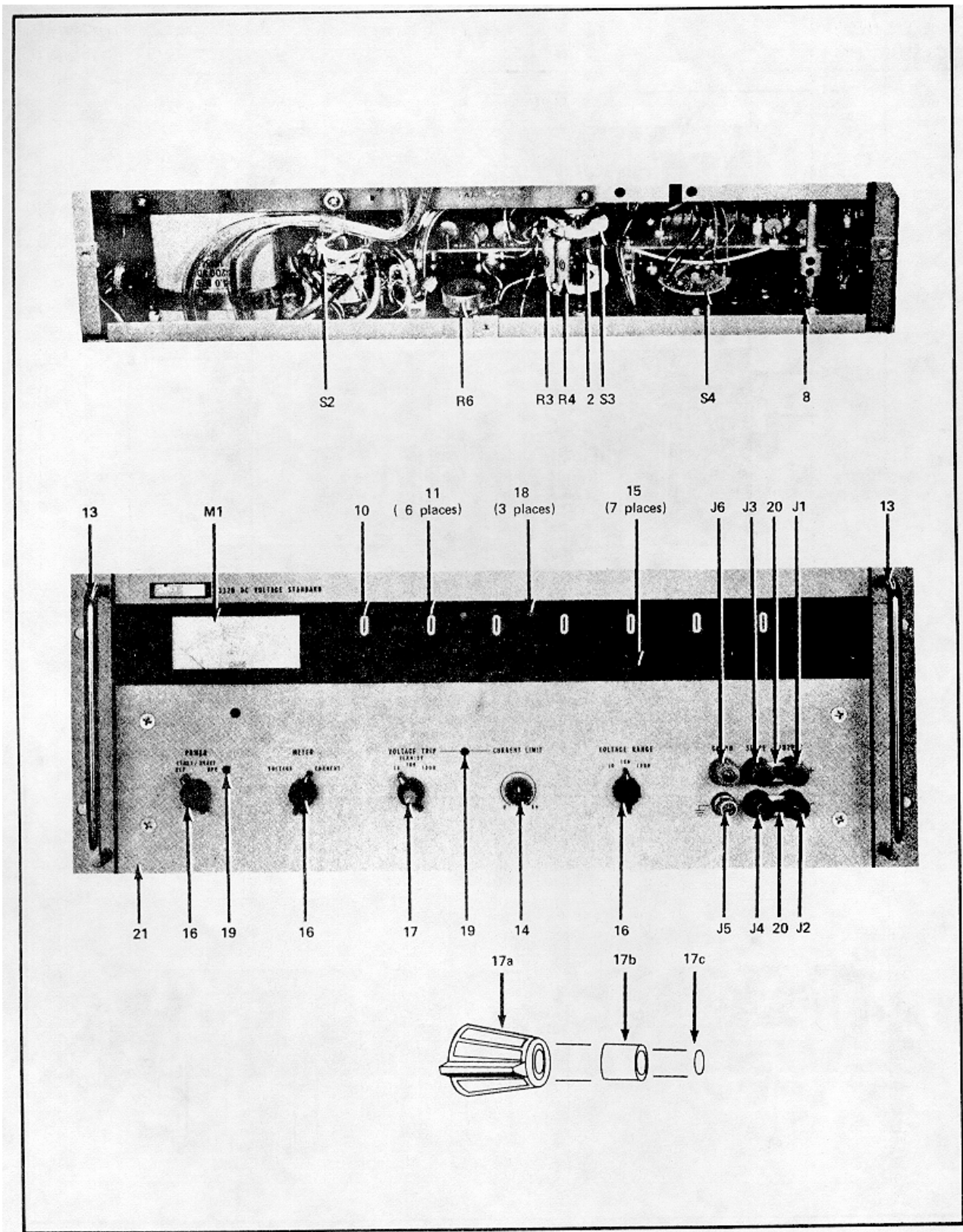

Figure 5-1. DC VOLTAGE STANDARD (Sheet 3 of 3)

REF DESIG	INDEX NO	DESCRIPTION	STOCK NO	MFR	MFR PART NO	TOT QTY	REC QTY	USE CODE
A1		CAPACITOR P/C ASSEMBLY Figure 5-2	1702-239343 (332B-4005)	89536	1702-239343	REF		
C1	E3-L3	Cap, plstc, 1 uf ± 20%, 250v	1507-19030	73445	C280A/P1M	8		
C2	E1-I2	Cap, plstc, 1uf ± 20%, 250	1507-190330	73445	C280AE/P1M	REF		
CR1	E1-J4	Diode, silicon, 1 amp, 100 piv	4802-116111	05277	1N4817	REF		
CR2	E2-I4	Diode, silicon, 1 amp, 100 piv	4802-11111	05277	1N4817	REF		

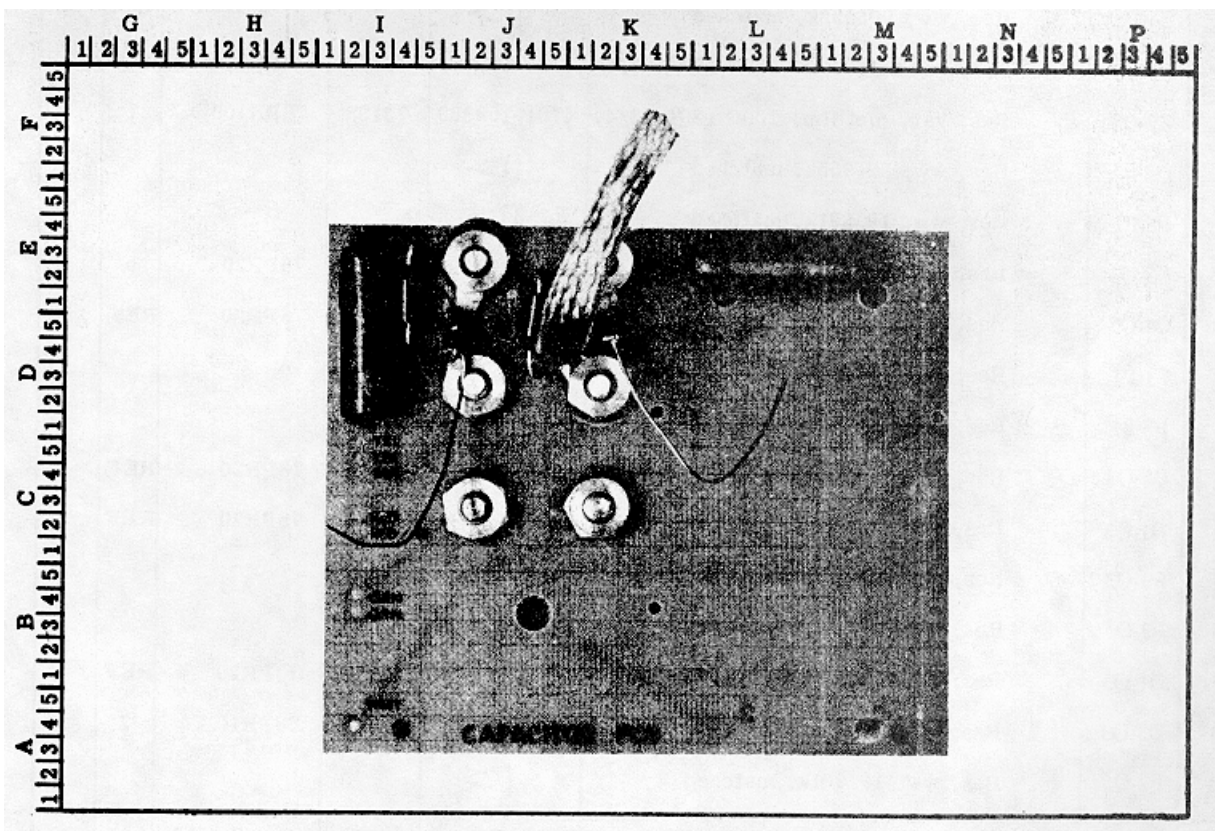

















Figure 5-2. CAPACITOR P/C ASSEMBLY

REF DESIG	INDEX NO	DESCRIPTION	STOCK NO	MFR	MFR PART NO	TOT QTY	REC QTY	USE CODE
A2		<b>SAMPLE STRING P/C ASSEMBLY</b> <b>Figure 5-3</b>						
R1	B3-P1	Res, ww, 99.955k, matched						
R2	B2-P5	Res, ww, 99.955k, matched						
R3	B2-Q3	Res, var, met flm, 200Ω ± 20%, 3/4w	4701-186213	73138	78PR200	5		
R4	B3-Q3	Res, var, met flm, 200Ω ± 20%, 3/4w	4701-186213	73138	78PR200	REF		
R5	B4-P5	Res, ww, 99.955k, matched						
R6	B5-P1	Res, ww, 99.955k, matched						
R7	C2-P1	Res, ww, 99.955k, matched						
R8	C1-P5	Res, ww, 99.955k, matched						
R9	B4-Q3	Res, var, met flm, 200Ω ± 20%, 3/4w	4701-186213	73138	78PR200	REF		
R10	B5-Q3	Res, var, met flm, 200Ω ± 20%, 3/4w	4701-186213	73138	78PR200	REF		
R11	C3-P5	Res, ww, 99.955k, matched						
R12	C5-P2	Res, ww, 99.955k, matched						
R13	D3-P2	Res, ww, 99.955k, matched						
R14	C5-P5	Res, ww, 99.955k, matched						
R15	C1-Q3	Res, var, met flm, 200Ω ± 20%, 3/4w	4701-186213	73138	78PR200	REF		
R16	C2-Q3	Res, var, met flm, 100Ω ± 20%, 3/4w	4701-159889	73138	78PR100	1		
R17	D2-P5	Res, ww, 99.955k, matched						
R18	E5-P1	Res, ww, 19.991k, matched						
R19	C3-Q3	Res, var, met flm, 20Ω ± 30%, 3/4w	4701-186197	73138	78PR20	5		
R20	C4-Q3	Res, var, met flm, 20Ω ± 30%, 3/4w	4701-186197	73138	78PR20	REF		
R21	F1-P1	Res, ww, 19.991k, matched						
R22	F3-P1	Res, ww, 19.991k, matched						
R23	C5-Q3	Res, var, met flm, 20Ω ± 30%, 3/4w	4701-186197	73138	78PR20	REF		
R24	D1-Q3	Res, var, met flm, 20Ω ± 30%, 3/4w	4701-186197	73138	78PR20	REF		
R25	F3-Q3	Res, ww, 19.991k, matched						
R26	E3-Q5	Res, ww, 19.991k, matched						
R27	D1-Q3	Res, var, met flm, 20Ω ± 30%, 3/4w	4701-186197	73138	78PR20	REF		
R28	D3-Q3	Res, var, met flm, 10Ω ± 30%, 3/4w	4701-186205	73138	78PR10	2		
R29	F2-Q5	Res, ww, 19.991k, matched						

REF DESIG	INDEX NO	DESCRIPTION	STOCK NO	MFR	MFR PART NO	TOT QTY	REC QTY	USE CODE
R30	F5-Q5	Res ww, 19.991k, matched	1					
R31	F5-P1	Res ww, 2k, matched	↑					
R32	G2-P1	Res, ww, 2k, matched						
R33	G4-P1	Res, ww, 2k, matched						
R34	H1-Q5	Res ww, 2k, matched						
R35	G3-Q5	Res ww, 2k, matched						
R36	G3-Q3	Res, ww, 1k, matched						
R37	H1-P1	Res, ww, 200Ω, matched						
R38	H2-P1	Res, ww, 200Ω, matched						
R39	H3-P2	Res, ww, 200Ω, matched						
R40	H5-Q4	Res, ww; 200Ω, matched						
R41	H3-Q4	Res, ww, 200Ω, matched						
R42	H4-Q4	Res, ww, 100Ω, matched						
R43	I1-P1	Res, ww, 20Ω, matched						
R44	H5-P1	Res, ww, 20Ω, matched						
R45	I2-P1	Res, ww, 20Ω, matched						
R46	I3-Q4	Res, ww, 20Ω, matched						
R47	I2-Q4	Res ww, 20Ω, matched						
R48	I4-Q4	Res ww, 10Ω, matched						
R49	I3-P1	Res, ww, 2Ω, matched						
R50	I4-P1	Res, ww, 2Ω, matched						
R51	I5-P1	Res ww, 2Ω, matched						
R52	J1-P1	Res, ww, 2Ω, matched						
R53	I5-Q4	Res, ww, 2Ω, matched						
R54	I5-Q4	Res, ww, 1Ω, matched						
R55	K2-T1	Res, ww, 0.2Ω, matched						
R55		Resistance wire, 0.1Ω (See S7)						
R56	K1-S5	Res, ww, 0.2Ω, matched						
R56		Resistance wire, 0.1Ω (See S7)						
R57	K2-T1	Res, ww, 0.2Ω, matched						
R57		Resistance wire, 0.1Ω (See S7)						
R58	K2-T2	Res, ww, 0.2Ω, matched						
R58		Resistance wire, 0.1Ω (See S7)						
R59	K1-T4	Res, ww, 0.2Ω, matched						
R59		Resistance wire, 0.1Ω (See S7)						
R60	K1-T3	Res, ww, 0.1Ω, matched						
R60		Resistance wire, 0.1Ω (See S7)						
R61		Resistance wire, 0.1Ω (See S7)						
thru			1					
R64								V

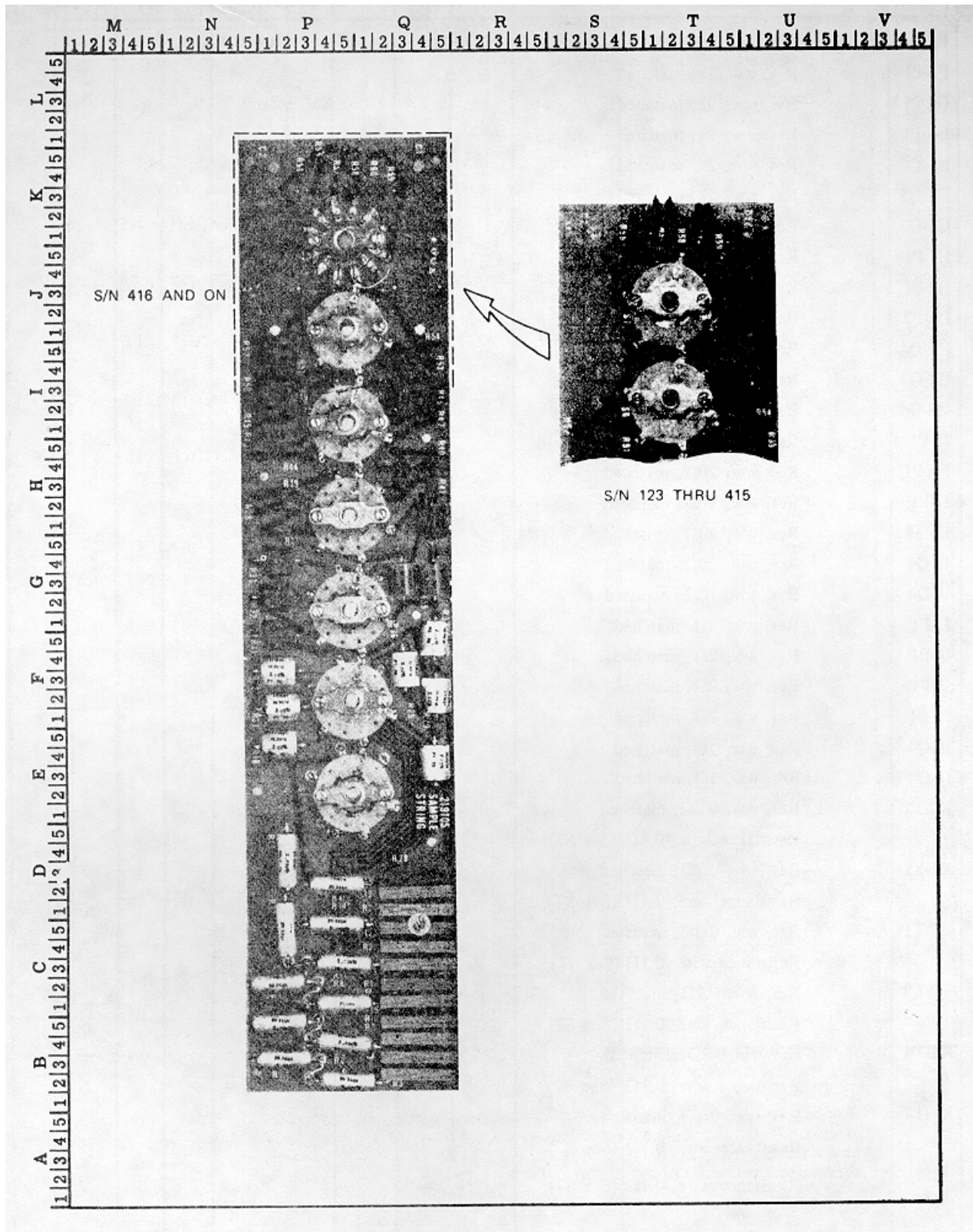

Figure 5-3. SAMPLE STRING P/C ASSEMBLY

REF DESIG	INDEX NO	DESCRIPTION	STOCK NO	MFR	MFR PART NO	TOT QTY	REC QTY	USE CODE
S1	E2-P5	Switch, DIGIT 1, rotary, 11 pos, 2 sect	5105-240697	89536	5105-240697	6		
S2	F2-P5	Switch, DIGIT 2, rotary, 11 pos, 2 sect	5105-240697	89536	5105-240697	REF		
S3	G2-P5	Switch, DIGIT 3, rotary, 11 pos, 2 sect	5105-240697	89536	5105-240697	REF		
S4	H2-P5	Switch, DIGIT 4, rotary, 11 pos, 2 sect	5105-240697	89536	5105-240697	REF		
S5	I2-P5	Switch, DIGIT 5, rotary, 11 pos, 2 sect	5105-240697	89536	5105-24097	REF		
S6	J2-P5	Switch, DIGIT 6, rotary, 11 pos, 2 sect	5105-240697	89536	5105-240697	REF		
S7	J3-T3	Switch, DIGIT 7, rotary, 11 pos, 2 sect	5105-2497	89536	5105-240697	REF		U
S7	K1-P5	Switch, DIGIT 7 rotary (Includes R55 thru R64, 0.1Ω resistance wire. For replacement of resistance wire, order a new S7 digit switch.)	5110-291021	89536	5110-291021	1		V



Factory matched resistance accuracy and temperature coefficient. When ordering, include all information stamped on the resistor (if not legible include information on adjacent resistors) in addition to the information requested in paragraph 5-6.



REF DESIG	INDEX NO	DESCRIPTION	STOCK NO	MFR	MFR PART NO	TOT QTY	REC QTY	USE CODE
A3		<b>CAPACITOR SWITCH P/C ASSEMBLY</b> <b>Figure 5-4</b>	1702-227603 (335A-4092)	89536	1702-227603	REF		
C1	D5-K1	Cap, elect, 400 uf +50/-10%, 25v	1502-168153	73445	C437ARF400	1	1	
CR1	D4-M2	Diode, silicon, 1 amp, 100 piv	4802-116111	05277	1N4817	REF		
K1	C5-I5 C5-J5	Relay, reed, 1,000v Coil, reed relay, 24v	5103-233916 1802-186155	12617 71707	Type DRR-5 SP-24-P	1 4		
Q1	D4-H4	Tstr, silicon, NPN	4805-203489	07910	CDQ10656	18	5	
R1	D5-M4	Res, comp, 100Ω ± 10%, 1/2w	4704-108100	01121	EB1011	2		
R2	D5-N2	Res, comp, 15k ±10%, 1/2w	4704-108530	01121	EB1531	6		
R3	C3-M4	Res, comp, 470Ω ± 10%, 1/2w	4704-108415	01121	EB4711	2		
R4	E3-H4	Res, comp, 10k ± 10%, 1/2w	4704-108118	01121	EB1031	8		
R5	D1-H5	Res, comp, 1k ± 10%, 1/2w	4704-108563	01121	EB1021	PEF		
R6	B5-I2	Res, comp, 100Ω ± 10%, 1/2w	4704-108100	01121	EB1011	REF		
R7	B5-J5	Res, comp, 39k ±5%, 1w	4704-236729	01121	CB3935	1		

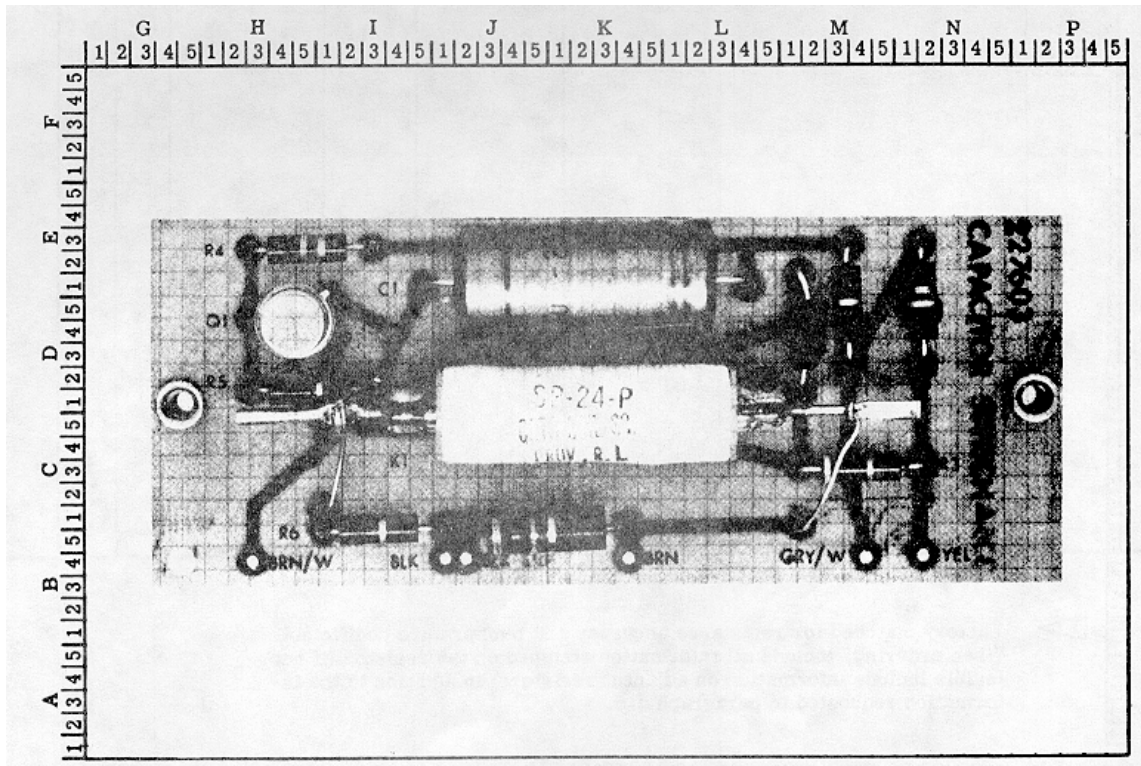



Figure 5-4. CAPACITOR SWITCH PC ASSEMBLY

REF DESIG	INDEX NO	DESCRIPTION	STOCK NO	MFR	MFR PART NO	TOT QTY	REC QTY	USE CODE
A4		<b>REFERENCE CALIBRATION P/C ASSEMBLY - Figure 5-5</b>	1702-219113 (335A-4052)	89536	1702-219113	REF		
C1	D1-I1	Cap, plstc, 0.1 uf ± 10%, 200v	1507-106013	56289	192P10492	1		
CR1	D3-G4	Diode, silicon, 1 amp, 100 piv	4802-116111	05277	1N4817	REF		
R1	C2-J1	Res, ww, Factory selected						
R2	D1-H3	Res, var, ww, 500Ω ± 5%, 3/4w	4702-187740	12697	Type 76JA-3	1		
R3	C5-J1	Res, ww, factory selected						
R4	D1-K1	Res, var, met flm, 500Ω ± 20%, 3/4w	4701-159897	73138	78PR500	1		
R5	D1-K4	Res, ww, 300.85k, matched						
R6	D1-L3	Res, ww, 300.85k, matched						
R7	D2-M1	Res, var met flm, 50Ω ± 20%, 3/4w	4701-186189	73138	78PR50	1		
R8	D2-M4	Res, ww, 60.17k, matched						W
R8	D2-M4	Re ww, 30.085k, matched						X
R9	D2-N2	Res, var, met flm, 10Ω ± 30%,3/4w	4701-186205	73138	78PR10	REF		
R10	D2-N4	Res, ww, 6.015k, matched						W
R10	D2-N4	Res, ww, 3.0075k, matched						X
R11	C2-N4	Res, ww, 3.0075k, matched						X
R12	C2-M4	Res, ww, 30.085k,matched						X
	D3-J3	Test point, red	2109-170480	74970	105-0752	1		
	D3-I5	Test point, black	2109-149112	74970	105-0753	1		

- 

Factory Selected. If replacement is required, include all information stamped on the resistor (if not legible include all information on the zener oven decal) in addition to the information requested in paragraph 5-6.
- 

Factory matched for resistance accuracy and temperature coefficient. When ordering, include all information stamped on the resistor (if not legible include information on adjacent resistors) in addition to the information requested in paragraph 5-6.

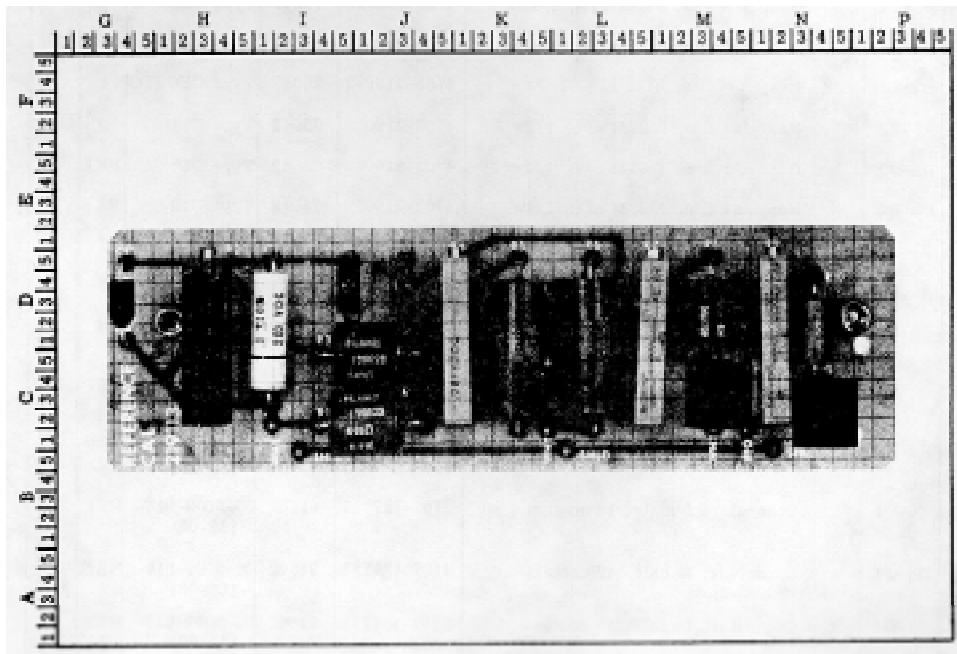

Figure 5-5. REFERENCE CALIBRATION P/C ASSEMBLY

REF DESIG	INDEX NO	DESCRIPTION	STOCK NO	MFR	MFR PART NO	TOT QTY	REC QTY	USE CODE
A5		<b>MAIN MOTHER BOARD P/C ASSEMBLY Figure 5-6</b>	1702-219238 (335A-4064)	89536	1702-219238	REF		
A5A1		Master Voltage Reference P/C Assembly (See Figure 5-7)	1702-298653 (335A-4101)	89536	1702-298653	REF		
A5A2		Series Pass Driver P/C Assembly (See Figure 5-8)	1702-219154 (335A-4056)	89536	1702-219154	REF		
A5A3		Differential Amplifier P/C Assembly (See Figure 5-9)	1702-219162 (335A-4057)	89536	1702-21912	REF		
A5A4		Chopper Amplifier P/C Assembly (See Figure 5-10)	1702-219170 (335A-4058)	89536	1702-219170	REF		
A5A5		Auxiliary Power Supply P/C Assembly (See Figure 5-11)	1702-219188 (335A-4059)	89536	1702-219188	REF		
A5A6		Current Limiter P/C Assembly (See Figure 5-12)	1702-219196 (335A-4060)	89536	1702-219196	REF		
C1	J4-T4	Cap, plstc, 0.1 uf 20%, 200v	1507-106435	56289	192P10402	5		
DS1	B3-Q2	Lamp, neon	3902-185017	74276	NE-7	2	5	
DS2	B4-P3	Lamp, neon	3902-185017	74278	NE-7	REF		
R1	B2-T3	Res, met flm, 23.7k $\pm$ 1%, 1/2w	4705-169383	75042	Type CEC-TO	2		
R2	B2-T1	Res, met flm, 25.5k $\pm$ 1%, 1/2w	4705-219006	75042	Type CEC-TO	1		
R3	B2-S4	Res, met flm, 267k $\pm$ 1%, 1/2w	4705-218990	75042	Type CEC-TO	1		
R4	B2-S3	Res, met flm, 274k $\pm$ 1%, 1/2w	4705-218982	75042	Type CEC-TO	1		
R5	A5-R2	Res, car flm, 1.82M $\pm$ 1%, 1/2w	4703-219089	75042	Type C12	3		
R6	B1-R2	Res, car flm, 1.82M $\pm$ 1%, 1/2w	4703-219089	75042	Type C12	REF		
R7	B2-R2	Res, car flm, 1.82M $\pm$ 1%, 1/2w	4703-219089	75042	Type C12	REF		
R8	C1-R3	Res, comp, 1k $\pm$ 10%, 1w	4704-109371	01121	GB1021	1		
R9	A5-P2	Res, comp, 470 $\Omega$ $\pm$ 10%, 1w	4704-109710	01121	GB4711	1		
XA5A1	K3-P5	Connector, female, 16 contact	2107-187732	91662	00-5009-016- 153-001	8		
XA5A2	I5-Q1	Connector, female, 16 contact	2107-181732	91662	00-5009-016- 153-001	REF		
XA5A3	H2-Q2	Connector, female, 16 contact	2107-187732	91662	00-5009-016- 153-001	REF		
XA5A4	F4-Q3	Connector, female, 16 contact	2107-187732	91662	00-5009-016- 153-001	REF		
XA5A5	D5-Q3	Connector, female, 16 contact	2107-187732	91662	00-5009-016- 153-001	REF		
XA5A6	C2-Q4	Connector, female, 16 contact	2107-187732	91662	00-5009-016- 153-001	REF		

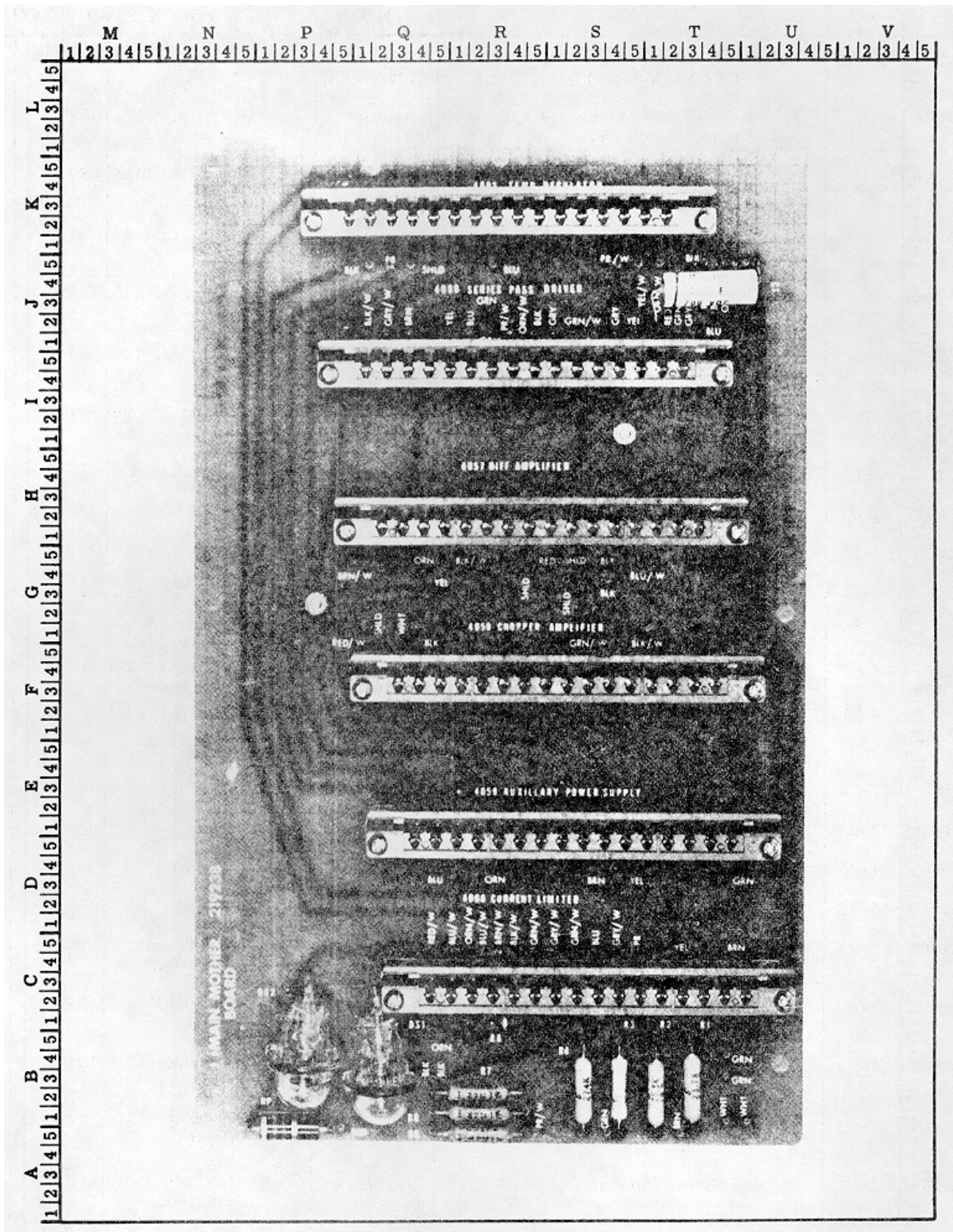

Figure 5-6. MAIN MOTHER BOARD P/C ASSEMBLY

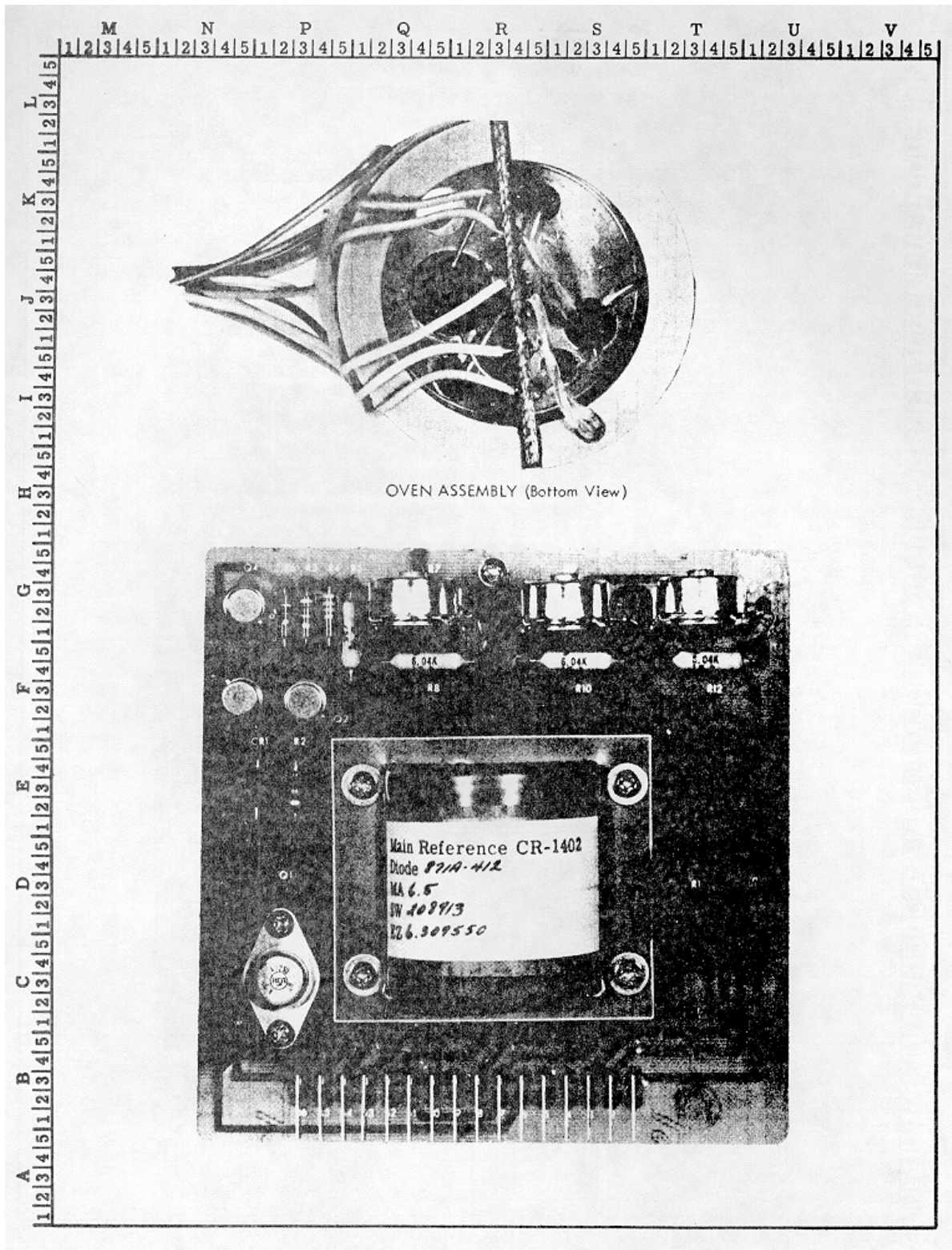







Figure 5-7. MASTER VOLTAGE REFERENCE P/C ASSEMBLY

REF DESIG	INDEX NO	DESCRIPTION	STOCK NO	MFR	MFR PART NO	TOT QTY	REC QTY	USE CODE
A5A1		<b>MASTER VOLTAGE REFERENCE P/C ASSEMBLY - Figure 5-7</b>	1702-298653 (335A-401)	89536	1702-298653	REF		
CR1 P1	E3-P1 B1-P4	Diode, silicon, 1 amp, 100 piv Connector, male, 16 contact	4802-116111 2818-187724	05277 91662	1N4817 02-016-013 5-200	REF 8		
C1 Q1 Q2 Q3 Q4	F2-R2 C2-P1 F2-P3 F2-N5 G2-N5	Cap, mica, 470 pf $\pm 5\%$ , 500v Tstr, silicon, NPN Tstr, silicon, NPN Tstr, silicon, NPN Tstr, silicon, NPN	1504-148429 4805-183004 4805-203489 405-203489 4805-203489	14855 95303 07910 07910 07910	CD19F471J 40250 CDQ10656 CDQ10656 CDQ10656	1 6 REF REF REF	1	N
R1	D3-T3	Res, ww, factory selected						
R2	E3-P3	Res, comp, 10k $\pm 10\%$ , 1/2w	4704-108118	01121	EB1031	REF		
R3	G2-P3	Res, comp, 75k $\pm 5\%$ , 1/2w	4704-108928	01121	EB7535	4		
R4	G2-P4	Res, comp, 33k $\pm 10\%$ , 1/2w	4704-178541	01121	EB3331	2		
R5	F5-P5	Res, met flm, 75k $\pm 1\%$ , 1/2w	4705-193961	75042	Type CEC-TO	1		
R6	G2-P2	Res, comp, 24k $\pm 5\%$ , 1/2w	4704-108654	01121	EB2435	1		
R7	G3-Q3	Res, var, ww, 10k $\pm 10\%$ , 1-1/4w	4702-195164	71450	Type 115 special	3		
R8	F4-Q4	Res, met flm, 6.04k $\pm 1\%$ , 1/2w	4705-162588	75042	Type CEC-TO	4		
R9	G3-S2	Res, var, ww, 10k $\pm 10\%$ , 1-1/4w	4702-195164	71450	Type 115 special	REF		
R10	F4-S3	Res, met flm, 6.04k $\pm 1\%$ , 1/2w	4705-162586	75042	Type CEC-TO	REF		
R11	G3-T3	Res, var, ww, 10k $\pm 10\%$ , 1-1/4w	4702-195164	71450	Type 115 special	REF		
R12 S1	F4-T4 K3-Q5	Res, met flm, 6.04k $\pm 1\%$ , 1/2w Thermostat, snap acting (not illustrated)	4705-162586 5301-228999	75042 01295	Type CEC-TO 9700L-21-11	REF 1	1	
	C5-N5 D1-R5	Heat sink Oven Assembly	4806-186759	89536	4808-186759	3		
CR1401	K3-R5	Diode, zener, matched						
CR1402	I5-S1	Diode, zener, matched						
Q1401	J4-Q5	Tstr, silicon, PNP	4805-190389	04713	SM4144	4	1	
R1401	J2-S3	Res, ww, 110 $\Omega$ $\pm 5\%$	4707-183830	89536	4707-183830	1		
R1402	I2-S3	Thermistor, 500k at 25° C	4708-185975	15801	GA55P2	1	1	
R1403	I4-R1	Res, met flm, selected						

 Factory Selected. If replacement is required, include all information stamped on the resistor (if not legible please include all information on the zener oven decal) in addition to the information requested in paragraph 5-6.

 CR1401 and CR1402 comprise a specially matched zener reference set. Many of the resistors on the Master Voltage Reference Assembly are selected and/or matched to the characteristics of these reference elements. Consequently, should either or both of these units require replacing, it is recommended that the complete Master Voltage Reference Assembly (A5A), part number 1702-298653, be replaced. A4R1 and A4R3 must also be replaced and are included under this part number.

REF DESIG	INDEX NO	DESCRIPTION	STOCK NO	MFR	MFR PART NO	TOT QTY	REC QTY	USE CODE
A5A2		<b>SERIES PASS DRIVER P/C ASSEMBLY - Figure 5-98</b>	1702-219154 (335A-4056)	89536	1702-219154	REF		
C1	G4-P4	Cap , plstc, 0.47 uf ± 20%, 250v	1507-184366	73445	C280AE/P470 K	1		
C2	F2-Q5	Cap, Ta, 2.2 uf ± 10%, 20v	1508-160226	05397	K2R2C20K	1		
C3	E2-Q5	Cap, plstc, 0.1 uf ±20%, 200v	1507-106435	56289	192P10402	REF		
C4	G2-U5	Cap, plstc, 0.22 uf ± 10%, 80v	1507-159392	56289	192P2249R8	1		
C5	H1-Q1	Cap, Ta, 15 uf ±10%, 20v	1508-153056	05397	K15C20K	2		
CR1	I4-R1	Diode, silicon, 150 ma, 6 piv	4802-113308	07910	CD13161	5	1	C
CR1	I4-R1	Diode, silicon, 200 ma, 25 piv	4802-190272	93332	1N456A	2		D
CR	I4-R1	Diode, silicon, 1 amp, 100 piv	4802-116111	05277	1N4817	REF		E
CR2	I4-41	Diode, silicon, 150 ma, 6 piv	4802-113308	07110	CD13161	REF		C
CR2	I4-S1	Diode, silicon, 200 ma, 25 piv	4802-19022	93332	1N456A	REF		D
CR2	I4-S1	Diode silicon, 1 amp, 100 piv	4802-116111	05277	1N4817	REF		E
CR3	F5-R3	Diode, zener, 10v	4803-113324	07910	1N961A	3	1	
CR4	E5-Q3	Diode, silicon, 1 amp, 100 piv	4802-116111	05277	1N4817	REF		
CR5	H3-U3	Diode, zener, 10v	4803-113324	07910	1N961A	REF		
CR6	F4-T1	Diode, silicon, 1 amp, 100 piv	4802-116111	05217	1N4817	REF		
CR7	D5-U2	Diode, silicon, 1 amp, 100 piv	4802-116111	05277	1N4817	REF		
CR8	D3-T4	Diode, silicon, 1 amp, 100 piv	4802-116111	05277	1N4817	REF		
CR9	D1-T4	Diode, silicon, 1 amp, 100 piv	4802-116111	05277	1N4817	REF		
CR10	F2-T3	Diode, germanium, 75 ma, 125 piv	4802-150342	93332	1N277	1	1	L
CR10	F2-T3	Diode, silicon, 150 ma, 6 piv	4802-113308	07910	CD13161	4	M	
CR11	F1-U2	Diode, silicon, 150 ma, 6 piv	4802-113308	07910	CD13161	REF		
CR12	E3-U4	Diode, silicon, 150 ma, 6 piv	4802-113308	07910	CD13161	REF		
CR13	E3-R2	Diode, silicon, 1 amp, 100 piv	4802-116111	05277	1N4817	REF		
CR14	H2-P2	Diode, zener, 4.3v	4803-180455	07910	1N749A	1	1	
CR15	J1-R3	Diode silicon, 1 amp, 100 piv	4802-116111	05277	1N4817	REF		E
P1	C2-Q2	Connector, male, 16 contact	2816-187724	91662	02-016-013- 5-200	REF		
Q1	F3-Q5	Tstr, tested, silicon, PNP	4805-159491	89536	4805-159491	11	2	
Q2	C5-R2	Tstr, silicon, NPN	4805-203489	07910	CDQ10656	REF		

REF DESIG	INDEX NO	DESCRIPTION	STOCK NO	MFR	MFR PART NO	TOT QTY	REC QTY	USE CODE
Q3	G4-N4	Tstr, silicon, NPN	4805-183004	95303	40250	REF		
Q4	H1-Q3	Tar, tested, silicon, PNP	4805-159491	89536	4805-159491	REF		
Q5	E5-S4	Tstr, silicon, NPN	4805-203489	07910	CDQ10656	REF		
Q6	G5-U2	Tstr, tested, silicon, PNP	4805-159491	89536	4805-159491	REF		
Q7	E3-T4	Tstr, silicon, NPN	4805-203489	07910	CDQ10656	REF		
Q8	E1-Q1	Tstr, tested, silicon, PNP	4805-159491	89536	4805-159491	REF		
R1	E2-N3	Res, met flm, 4.02k $\pm$ 1%, 1/2w	4705-167478	75042	Type CEC-TO	2		
R2	J3-T3	Res, var, ww, 2k $\pm$ 10%, 1-1/4w	4702-198416	71450	Type 110	1		
R3	E3-N1	Res, comp, 2.7k $\pm$ 1%, 1w	4704-109496	01121	GB2721	1		
R4	E3-M5	Res, met flm, 4.02k $\pm$ 1%, 1/2w	4705-167478	75042	Type CEC-TO	REF		
R5	J3-P4	Res, var, ww, 3k $\pm$ 20% 1-1/4w	4702-149781	71450	Type 110	2		
R6	I5-S5	Res, met flm, 5.62k $\pm$ 1%, 1/2w	4705-219014	75042	Type CEC-TO	1		
R7	G2-R2	Res, comp, 100k $\pm$ 1%, 1/2w	4704-108128	01121	EB1041	3		
R9	G1-P2	Res, comp, 2.4k $\pm$ 5%, 1/2w	4704-108902	01121	EB2425	1		
R10	I1-P5	Res, comp, 47 $\Omega$ $\pm$ 1%, 2w	4704-144352	01121	HB4701	2		
R11	E2-P2	Res, comp, 47 $\Omega$ $\pm$ 1%, 2w	4704-144352	01121	HB4701	REF		
R12	E3-N5	Res, comp, 36k $\pm$ 5%, 1/2w	4704-185991	01121	EB3635	4		
R13	I1-R5	Res, var, ww, 3k $\pm$ 2%, 1-1/4w	4702-149781	71450	Type 110	REF		
R14	D3-S1	Res, met flm, 1k $\pm$ 1%, 1/2w	4705-151324	75042	Type CEC-TO	1		
R15	E2-R4	Res, met flm, 221k $\pm$ 1%, 1/2w	4705-182527	75042	Type CEC-TO	3		
R16	G2-S4	Res, comp, 3.9k $\pm$ 1%, 1/2w	4704-161406	01121	EB3921	1		
R17	E1-S3	Res, comp, 20k $\pm$ 5%, 1/2w	4704-109041	01121	EB2035	3		
R18	G3-T3	Res, comp, 16k $\pm$ 5%, 1/2w	4704-159632	01121	EB1635	3		
R19	G5-S3	Res, comp, 10k $\pm$ 10, 1/2w	4704-108118	01121	EB1031	REF		
R20	F5-T2	Res, comp, 27k $\pm$ 5%, 1/2w	4704-186023	01121	EB2735	1		
R21	F4-U2	Res, comp, 220 $\Omega$ $\pm$ 5%, 1/2w	4704-186031	01121	EB2215	1		L
R21	F4-U2	Res, comp, 27 $\Omega$ $\pm$ 5%, 1/2w	4704-260984	01121	EB2705	1		M
R22	E1-U2	Res, met flm, 10 $\pm$ 1%, 1/2w	4705-151043	75042	Type CEC-TO	1		
R23	D2-S5	Res, comp, 47k $\pm$ 5%, 1/2w	4704-108738	01121	EB4735	2		
R24	H2-S2	Res, comp, 620 $\Omega$ $\pm$ 5%, 1/2w	4704-108704	01121	EB6215	2		
R25	H4-Q5	Res, comp, 47k $\pm$ 5%, 1/2w	4704-108738	01121	EB4735	REF		
R26	D3-P5	Res, comp, 180 $\pm$ 10%, 2w	4704-155457	01121	HB1811	1		



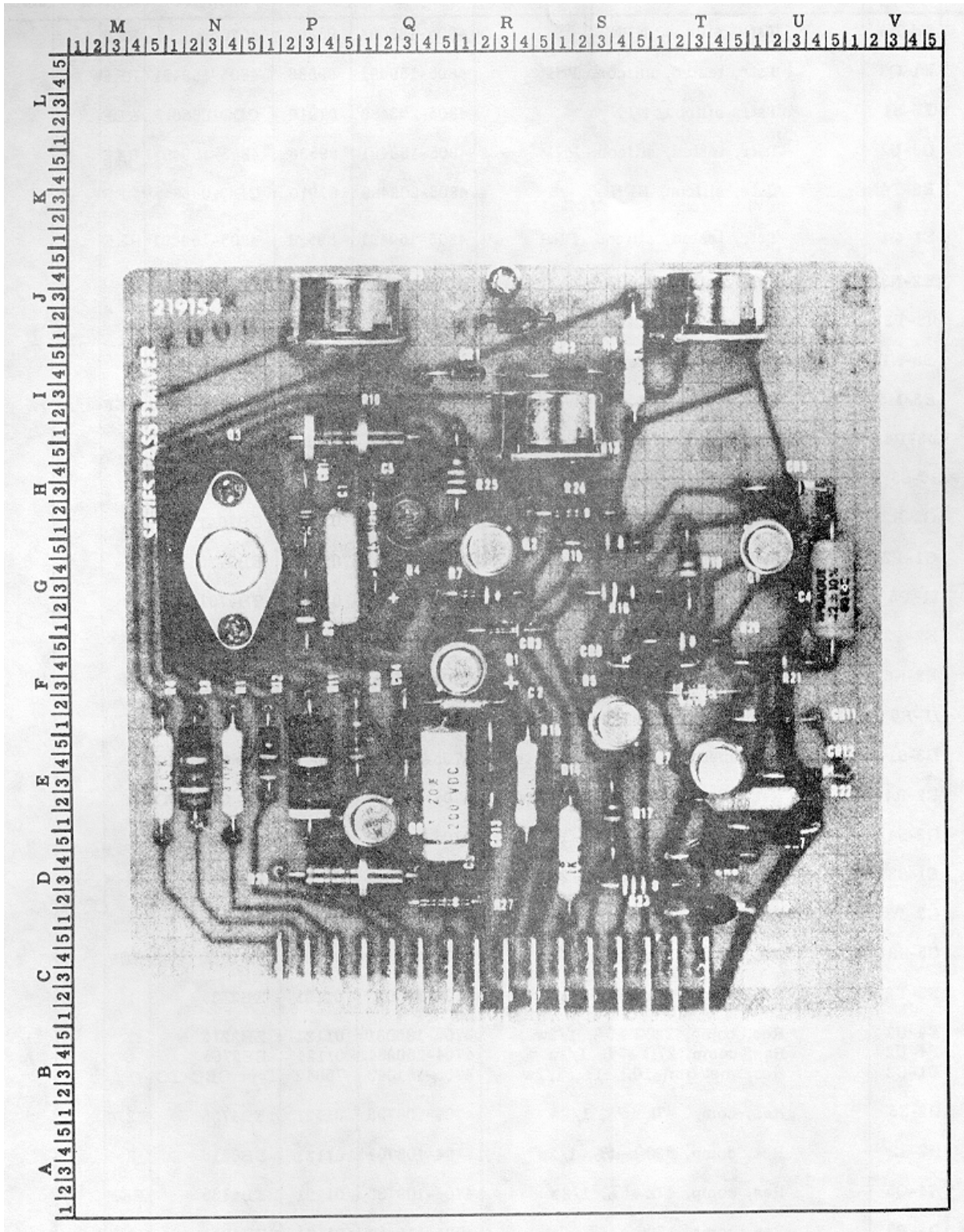

Figure 5-8. SERIES PASS DRIVER P/C ASSEMBLY

REF DESIG	INDEX NO	DESCRIPTION	STOCK NO	MFR	MFR PART NO	TOT QTY	REC QTY	USE CODE
R27	D1-Q5	Res, comp, 2k* 5%, 4/2w	4704-169854	01121	EB2025	3		
R28	E5-P5	Res, comp, 8. 2k 5%, 1/2w	4704-147777	01121	EB8225	2		
	G1-N1	Heat sink	4806-186759	89536	4806-186759	REF		

REF DESIG	INDEX NO	DESCRIPTION	STOCK NO	MFR	MFR PART NO	TOT QTY	REC QTY	USE CODE
A5A3		<b>DIFFERENTIAL AMPLIFIER P/C ASSEMBLY - Figure 5-9</b>	1702-219162 (335A-4057)	89536	1702-219162	REF		
C1	E3-PS	Cap, plstc, 0.1 uf+10%,50v	1507-150318	56289	194P1049R5	1		
C2	F4-Q5	Cap, mica, 510pf+5%,500v	1504-148411	88419	CD19F511J	2		
C3	G1-P3	Cap, Ta, 15 uf ± 10%, 20v	1508-153056	05397	KI5C20K	REF		
C4	14-R4	Cap, elect, 250 uf +50/-10%, 40v	1502-178616	73445	C437ARG250	1	1	
C5	11-S3	Cap, mica, 27 pf 5%, 500v	1504-177998	88419	CD15E270J	1		1
CR1	D4-RI	Diode, silicon, 1 amp, 100 piv	4802-116111	05277	1N4817	REF		
CR2	E5-SI	Diode, silicon, 1 amp, 100piv	4802-116111	05277	1N4817	REF		
CR3	G1-S2	Diode, silicon, 1 amp, 100piv	4802-116111	05277	1N4817	REF		
CR4	E4-R5	Diode, silicon, 1 amp, 100 piv	4802-116111	05277	1N4817	REF		
CR5	FS-R5	Diode, silicon, 1 amp, 100 piv	4802-116111	05277	1N4817	REF		
CR6	F3-RI	Diode, silicon, 1 amp, 00 piv	4802-116111	05277	1N4817	REF		
CR7	F1-RI	Diode, silicon, 1 amp, 100 piv	4802-116111	05277	1N4817	REF		
CR8	G2-RI	Diode, silicon, 1 amp, 100 piv	4802-116111	05277	1N4817	REF		
CR9	G1-RI	Diode, silicon, 1 amp, 100 piv	4802-116111	05277	1N4817	REF		
CR10	ES-S4	Diode, silicon, 1 amp, 100piv	4802-116111	05277	1N4817	REF		
CR11	G1-S5	Diode, silicon, 1 amp, 100 piv	4802-116111	05277	1N4817	REF		
CR12	G1-TI	Diode, silicon, 1 amp, 100 piv	4802-116111	05277	1N4817	REF		
CR13	G1-Q2	Diode, silicon, 1 amp, 100 piv	4802-116111	05277	1N4817	REF		
CR14	G1-NS	Diode, zener, 10v	4803-113324	07910	1N961A	REF		
CR15	13-T2	Diode, silicon, 1 amp, 100piv	4802-116111	05277	1N4817	REF		
P1	C3-Q2	Connector, male, 16 contact	2816-187724	91662	02-016-013- 5-200	REF		
Q1	D2-T1	Tstr, silicon, NPN	4805-177105	07263	2N3565	5		
Q2	D5-N2	Tstr, FET, silicon N-channel	4805-166223	15818	U-1249	2		
Q3	F2-N2	Tstr, silicon PNP	4805-190389	04713	SM4144	REF		
Q4	H2-Q1	Tstr, tested, silicon, NPN	4805-198812	89536	4805-198812	2	1	U
Q4	H2-Q1	Tstr, silicon, NPN	4805-168716	07263	S19254	2	1	V
Q5	I1-42	Tstr, silicon, PNP	4805-190389	04713	SM4144	REF		
Q6	D2-TS	Tstr, tested, silicon, NPN	4805-198812	89536	4805-198812	REF	U	
Q6	D2-T5	Tstr, silicon, NPN	4805-168716	07263	SM19254	REF	V	
Q7	D2-U3	Tstr, silicon, PNP	4805-190389	04713	SM4144	REF		
Q8	H3-R3	Tstr, silicon, NPN	4805-203489	07910	CDQ10656	REF		

REF DESIG	INDEX NO	DESCRIPTION	STOCK NO	MFR	MFR PART NO	TOT QTY	REC QTY	USE CODE
Q9	12-T5	Tstr, silicon, PNP	4805-183558	04713	2N3250	3	1	
Q10	E4-U3	Tstr, silicon, PNP	4805-183558	04713	2N3250	REF		
Q11	I1-U4	Tstr, silicon, PNP	4805-183558	04713	2N3250	REF		
Q12	E1-U3	Tstr, silicon, NPN	4805-177105	07263	2N3585	REF		
R1	D3-S1	Res, comp, 22k $\pm$ 5%, 1/2w	4704-186064	01121	EB2235	3		
R2	D3-R3	Res, comp, 100 $\Omega$ $\pm$ 5%, 1/2w	4704-188508	01121	EB1015	6		
R3	D3-R5	Res, comp, 100 $\Omega$ $\pm$ 5%, 1/2w	4704-188508	01121	EB1015	REF		
R4	D3-S3	Res, ww, 10k $\pm$ 0. 2%, 1/4w	4707-112177	89536	4707-112177	1		
R5	E5-S3	Res, comp, 100 $\Omega$ $\pm$ 5%, 1/2w	4704-188508	01121	EB1015	REF		
R6	F5-S3	Res, comp, 100 $\Omega$ $\pm$ 5%, 1/2w	4704-188508	01121	EB1015	REF		
R7	E4-T1	Res, comp, 1k $\pm$ 5%, 1/2w	4704-108597	01121	EB1025	9		
R8	D3-Q3	Res, comp, 3.3k $\pm$ 5%, 1/2w	4704-165761	01121	EB3325	4		
R9	D3-Q2	Res, comp, 3k $\pm$ 5%, 1/2w	4704-109090	01121	EB9025	2		
R10	D3-P5	Res, comp, 510 $\Omega$ $\pm$ 5%, 1/2w	4704-108951	01121	EB5115	1		
R11	E1-P1	Res, comp, 22M $\pm$ 10%, 1/2w	4704-108233	01121	EB2261	1		
R12	F1-M5	Res, comp, 6. 2k $\pm$ 5%, 1/2w	4704-108621	01121	EB6225	3		
R13	G1-N3	Res, comp, 2.2k $\pm$ 5%, 1/2w	4704-108506	01121	EB2225	2		
R14	G1-P1	Res, comp, 1. 2k $\pm$ 10%, 1/2w	4704-108803	01121	EB1221	1		
R15	F5-P5	Res, met flm, 100k $\pm$ 1%, 1/2w	4705-151316	75042	Type CEC-TO	REF		
R16	I1-P1	Res, met flm, 221k $\pm$ 1%, 1/2w	4705-182527	75042	Type CEC-TO	REF		
R17	H4-P1	Res, met flm, 40.2k $\pm$ 1%, 1/2w	4705-161059	75042	Type CEC-TO	2		
R18	G4-R1	Res, met flm, 75 $\Omega$ $\pm$ 1%, 1/2w	4705-150870	75042	Type CEC-TO	2		
RI	E4-T4	Res, met flm, 75 $\Omega$ $\pm$ 1%, 1/2w	4705-150870	75042	Type CEC-TO	REF		
R20	E4-T5	Res, met flm, 221k $\pm$ 1%, 1/2w	4705-182527	75042	Type CEC-TO	REF		
R21	F4-U4	Res, met flm, 40. 2k $\pm$ 1%, 1/2w	4705-161059	75042	Type CEC-TO	REF		
R22	H4-S83	Res, met flm, 6. 04k $\pm$ 1%, 1/2w	4705-162586	75042	Type CEC-TO	REF		
R23	H1-S5	Res, met flm, 42.2k $\pm$ 1%, 1/2v	4705-182501	75042	Type CEC-TO	1		
R24	H2-85	Res, met flm, 9. 09k 1%, 1/2	4705-151258	75042	Type CEC-TO	1		
R25	15-T5	Res, met flm, 15k $\pm$ 1%, 1/2w	4705-151498	75042	Type CEC-TO	1		
R26	F4-U3	Res, met flm, 1. 58k $\pm$ 1%, 1/2w	4705-182543	75042	Type CEC-TO	2		
R27	G5-T4	Res, met flm, 1. 58k $\pm$ 1%, 1/2w	4705-182543	75042	Type CEC-TO	REF		

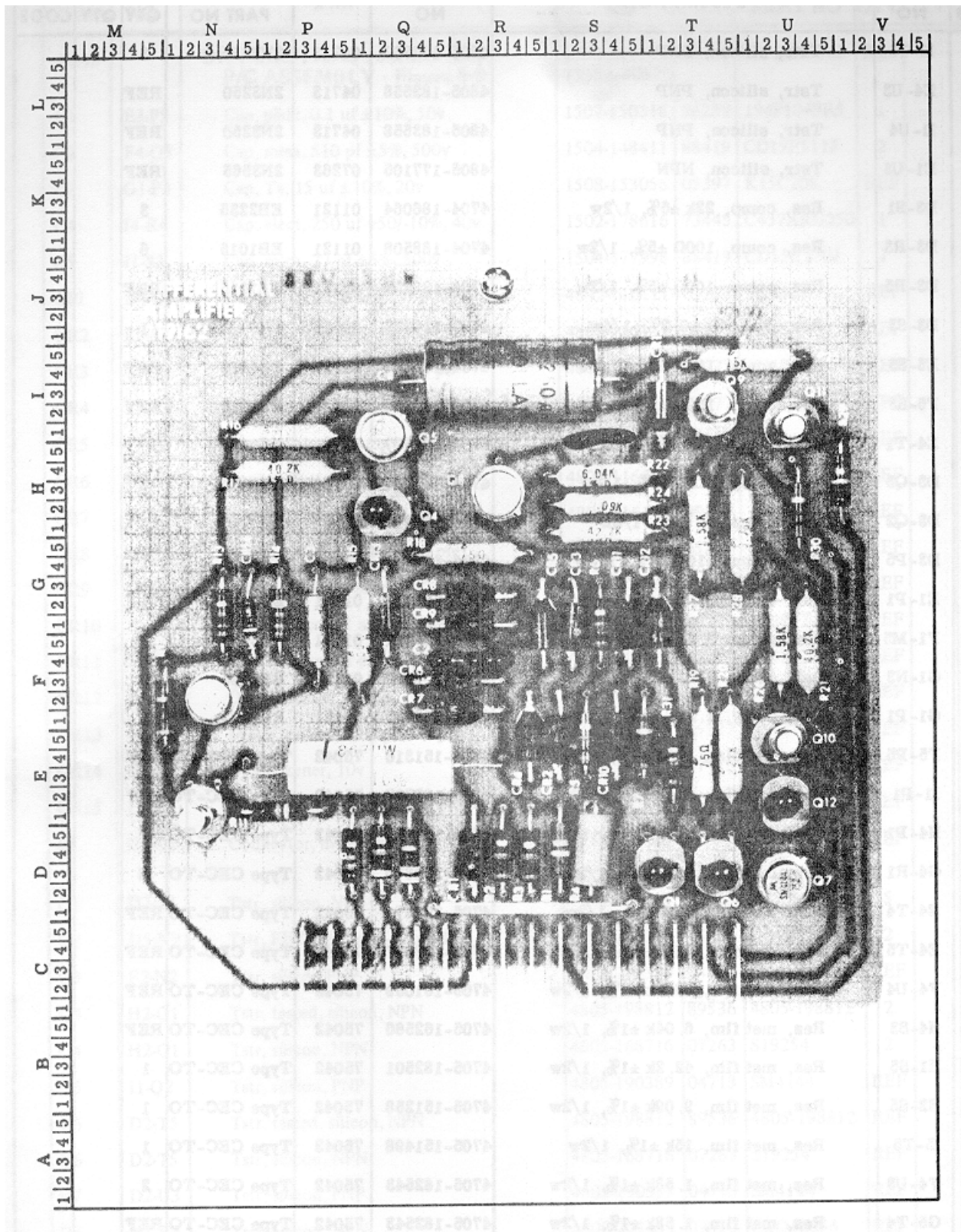





Figure 5-9. DIFFERENTIAL AMPLIFIER P/C ASSEMBLY

REF DESIG	INDEX NO	DESCRIPTION	STOCK NO	MFR	MFR PART NO	TOT QTY	REC QTY	USE CODE
R28	G5-U1	Res, met flm, 9. 76k $\pm$ 1%, 1/2w	4705-182485	75042	Type CEC-TO	3		
R29	DS-V1	Res, comp, 10k $\pm$ 5%, 1/2w	4704-109165	01121	EB1035	2		
R30	H2-U4	Res, comp, 1k, $\pm$ 5%, 1/2w	4704-108507	01121	EB1025	REF		L
R30	H2-U4	Res, comp, 1.5k $\pm$ 10%, 1/2w	4704-108159	01121	EB1521	1		M
R31	E3-T2	Res, comp, 2k $\pm$ 5%, 1/2w	4704-169854	01121	EB2025	REF		

REF DESIG	INDEX NO	DESCRIPTION	STOCK NO	MFR	MFR PART NO	TOT QTY	REC QTY	USE CODE
A5A4		<b>CHOPPER AMPLIFIER P/C ASSEMBLY - Figure 5-10</b>	1702-219170 (935A-4058)	89536	1702-219170	REF		
C1	E3-T3	Cap, platc, 0.033 uf ±10%, 200v 	1507-106062	56289	192P33392	2		
C2	E5-T3	Cap, plstc, 0.033 uf ±10%, 200v 	1507-106062	56289	192P33392	REF		
C3	E1-T3	Cap, platc, 0.1 uf ±20%, 200v 	1507-106435	56289	192P10402	REF		
C4	F3-T1	Cap, plstc, 0.01 uf ±20%, 100v 	1507-235390	84411	Type 663UW	1		
C5	G2-T4	Cap, cer, 0.01 uf ±20%, 100v	1501-149153	56289	C023B101F- 103M	2		
C6	F4-U4	Cap, elect, 100 uf +75/-10%, 25v	1502-106518	56289	30D107G025- DH4	2	1	
C7	H2-U2	Cap, elect, 20 uf +75/-10%, 50v	1502-106229	80183	TE1305	9	1	
C8	14-82	Cap, cer, 0.0012 uf ±10%, 500v	1501-106732	71590	CF-122	1		
C9	H1-84	Cap, elect, 100uf +75/-10%, 25v	1502-106518	56289	30D107G025- DH4	REF		
C10	J1-P5	Cap, elect, 20 uf +75/-10%, 50v	1502-106229	80183	TE 1305	REF		
C11	I1-Q2	Cap, cer, 0.01 uf ±20%, 100v	1501-149153	56289	C023B101F- 103M	REF		
C12	G2-Q1	Cap, elect, 20 uf +75/-10%, 50v	1502-106229	80183	TE1305	REF		
C13	H2-P2	Cap, elect, 20 uf +75/-10%, 50v	1502-106229	80183	TE1305	REF		
C14	G3-N3	Cap, Ta, 330 uf +10%, 6v	1508-193011	05397	K330J6K	2		
C15	E3-N3	Cap, Ta, 330 uf ±10%, 6v	1508-193011	05397	K330J6K	REF		
CR1	D4-P3	Diode, silicon, 1 amp, 100 piv	4802-116111	05277	1N4817	REF		
CR2	D5-P2	Diode, silicon, 1 amp, 100 piv	4802-116111	05277	1N4817	REF		
CR3	F1-N5	Diode, silicon, 1 amp, 100 piv	4802-116111	05277	1N4817	REF		
CR4	E3-P4	Diode, silicon, 1 amp, 100 piv	4802-116111	05277	1N4817	REF		
G1	C2-R2	Chopper, mechanical, dpdt, 10v	5901-104349	80640	CH1413	1		
P1	C4-Q3	Connector, male, 16 contact	2816-187724	91662	02-016-013- 5-200	REF		
Q1	F5-T2	Tstr, FET, silicon N-channel	4805-166223	15818	U-1249	REF		
Q2	G4-T2	Tstr, silicon, PNP	4805-190389	04713	SM4144	REF	A	
Q2	G4-T2	Tstr, silicon, PNP	4805-218388	07263	2N3645	1	B	
Q3	I4-U2	Tstr, silicon, NPN	4805-177105	07263	2N3565	REF		

REF DESIG	INDEX NO	DESCRIPTION	STOCK NO	MFR	MFR PART NO	TOT QTY	REC QTY	USE CODE
Q4	14-T1	Tstr, silicon, NPN	4805-177105	07263	2N3565	REF		
Q5	12-N3	Tatr, silicon, NPN	4805-177105	07263	2N3565	REF		
R1	E4-S4	Res, comp, 22k $\pm$ 5%, 1/2w	4704-186064	01121	EB2235	REF		
R2	F1-S1	Res, comp, 2. 2k $\pm$ 5%, 1/2w	4704-108506	01121	EB2225	REF		
R3	D3-T1	Res, met flm, 604k $\pm$ 1%, 1/2w	4705-1a2493	75042	Type CEC-TO	1		
R4	D1-T1	Res, met flm, 604k $\pm$ 1%, 1/2w	4705-182493	75042	Type CEC-TO	REF		F
R4	D1-T1	Res, met flm, 750k $\pm$ 1%, 1/2w	4705-155192	75042	Type CEC-TO	1		G
R5	D1-R5	Res, comp, 10 $\Omega$ $\pm$ 10%, 1/2w	4704-108092	01121	EB1001	1		F
R5	D1-R5	Res, comp, 12 $\Omega$ $\pm$ 10%, 1/2w	4704-187831	01121	EB1201	1		G
R6	F2-T2	Res, comp, 3. 3M $\pm$ 10%, 1/2w	4704-108282	01121	EB3351	1		
R7	D2-U4	Res, comp, 16k $\pm$ 5%, 1/2w	4704-159632	01121	EB1635	REF		
R8	F3-U2	Res, comp, 200 $\Omega$ $\pm$ 5%, 1/2w	4704-169839	01121	EB2015	1		A
R8	F3-U2	Res, comp, 360n $\pm$ 5%, 1/2w	4704-192559	01121	EB3615	2		B
R9	F5-U1	Res, comp, 15k $\pm$ 10%, 1/2w	4704-108530	01121	EB1531	REF		
R10	G3-T1	Res, comp, 6. 2k *5%, 1/2w	4704-108621	01121	EB6215	REF		
R11	H5-TS	Res, comp, 15k $\pm$ 10%, 1/2w	4704-108530	01121	EB1531	REF		
R12	H5-U4	Res, met flm, 150 $\Omega$ $\pm$ 1%, 1/2w	4705-182550	75042	Type CEC-TO	1		
R13	H4-T2	Res, comp, 120k $\pm$ 10%, 1/2w	4704-108779	01121	EB1241	1		
R14	H4-T3	Res, comp, 47k $\pm$ 10%, 1/2w	4704-108480	01121	EB4731	1		
R15	I3-P5	Res, comp, 15k $\pm$ 10%, 1/2w	4704-108530	01121	EB1531	REF		
R16	J1-54	Res, met flm, 23.7k $\pm$ 1%, 1/2w	4705-169383	75042	Type CEC-TO	REF		
R17	G2-S1	Res, comp, 10k $\pm$ 10%, 1/2w	4704-108118	01121	EB1031	REF		
R18	15-N4	Res, comp, 30k $\pm$ 5%, 1/2w	4704-186015	01121	EB3035	1		
R19	H4-Q1	Res, comp, 15k $\pm$ 10%, 1/2w	4704-108530	01121	EB1531	REF		
R20	H2-N5	Res, met flm, 3. 01k $\pm$ 1%, 1/2w	4705-196709	75042	Type CEC-T2	2		
R21	H2-P4	Res, met flm, 3. 01k $\pm$ 1%, 1/2w	4705-196709	75042	Type CEC-T2	REF		
R22	F4-P3	Res, met flm, 9. 76k $\pm$ 1%, 1/2w	4705-182485	75042	Type CEC-TO	REF		
R23	F4-P4	Res, met flm, 9.76k $\pm$ 1%, 1/2w	4705-182485	75042	Type CEC-TO	REF		
R24	DS-Q2	Res, comp, 36k $\pm$ 5%, 1/2w	4704-185991	01121	EB3635	REF		
R25	E2-P2	Res, comp, 20k $\pm$ 5%, 1/2w	4704-109041	01121	EB2035	REF		



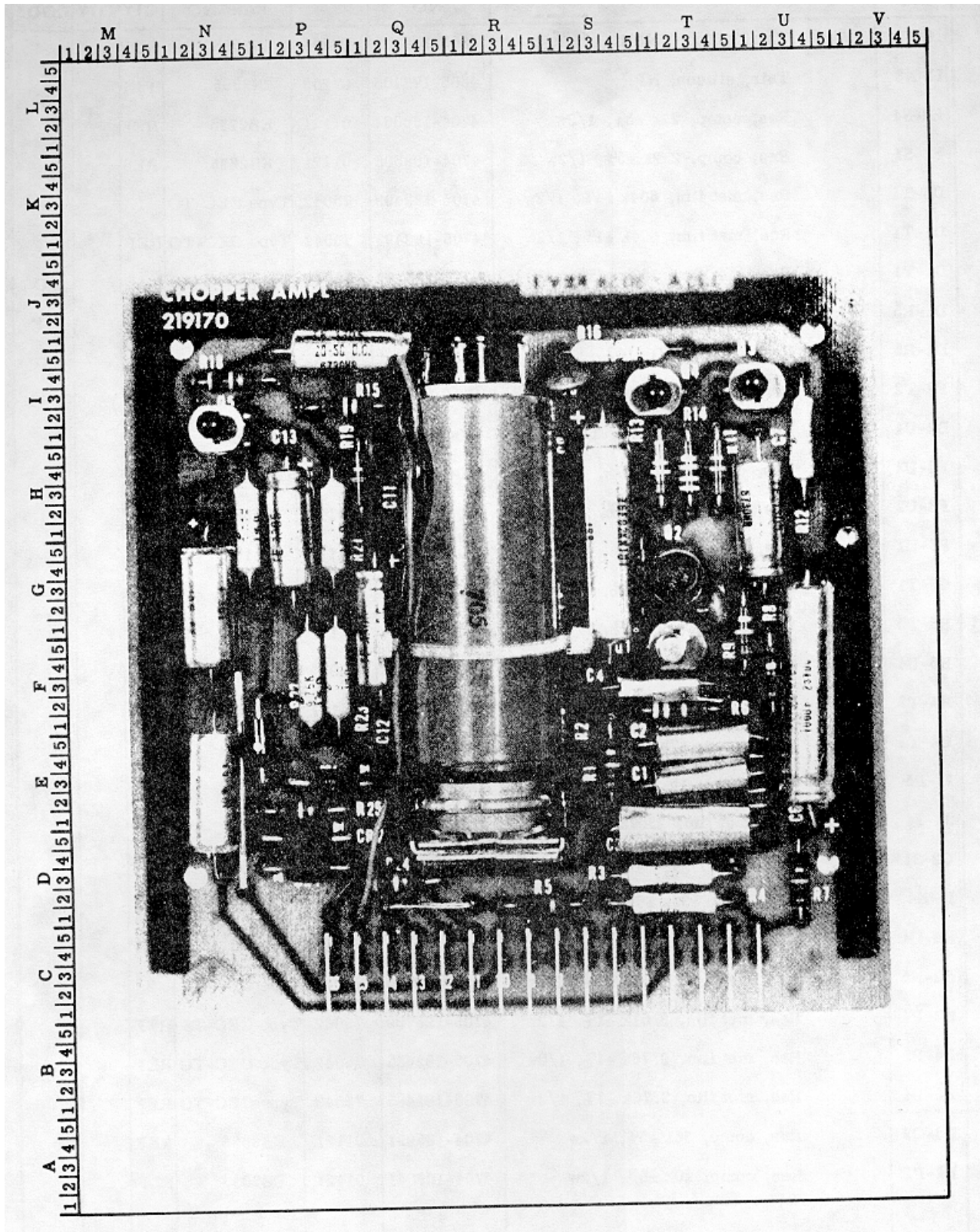

Figure 5-10. CHOPPER AMPLIFIER P/C ASSEMBLY

REF DESIG	INDEX NO	DESCRIPTION	STOCK NO	MFR	MFR PART NO	TOT QTY	REC QTY	USE CODE
XG1	E1-R1	Socket, chopper, 9 contact	2112-104358	91862	40083EG-3/32	1		
	J1-R1	Cap, chopper	2103-103234	80640	252-05	1		
		Cover, front (not illustrated)	3156-186809	89536	3156-186809	1		
		Cover, rear (not illustrated)	3156-186817	89538	3156-i88817	1		



See Section 4-12 for replacement instructions.

REF DESIG	INDEX NO	DESCRIPTION	STOCK NO	MFR	MFR PART NO	TOT QTY	REC QTY	USE CODE
A5A5		<b>AUXILIARY POWER SUPPLY P/C ASSEMBLY - Figure 5-11</b>	1702-219188 (335A-4059)	89536	1702-219188	REF		
C1	G1-P5	Cap, Ta, 68 uf $\pm$ 10%, 15v	1508-182824	05397	K68C15K	1		
C2	GI-N3	Cap, elect, 250 uf +50/-10%, 64v	1502-185850	73445	C437ARH250	4	1	
C3	G1-P2	Cap, elect, 50 uf +75/-10%, 50v	1502-105122	80183	TE1307	3	1	
C4	J1-P3	Cap, cer, 220 pf $\pm$ 10%, 500v	1501-105528	72982	315-024X5UD- 22 1K	1		O
C5	H1-R3	Cap, plstc, 2 uf $\pm$ 20%, 100v	1507-106963	84411	Type X663FR	2		
C6	E2-R3	Cap, plstc, 0.1 uf $\pm$ 20%, 200v	1507-106435	56289	192P10402	REF		
C7	H5-R2	Cap, elect, 20 uf +75/-10%, 50v	1502-106229	80183	TE1305	REF		
CB	E3-U3	Cap, elect, 50 uf +75/-10%, 50v	1502-105122	80183	TE1307	REF		
C9	HI-T1	Cap, plstc, 0.0012 uf $\pm$ 10%, 200v	1507-106088	56289	192P12292	1		
C10	E2-T1	Cap, plstc, 2 uf $\pm$ 20%, 100v	1507-106963	84411	Type X663FR	REF		
C11	I1-U5	Cap, elect, 20 uf +75/-10%, 50v	1502-106229	80183	TE1305	REF		
C12	H5-P4	Cap, plstc, 0.1 uf $\pm$ 20%, 200v	1507-106435	56289	192P10402	REF		P
CR1	E2-N5	Diode, silicon, 1 amp, 100 piv	4802-116111	05277	1N4817	REF		
CR2	D3-N5	Diode, silicon, 1 amp, 100 piv	4802-116111	05277	1N4817	REF		
CR3	E4-N5	Diode, silicon, 1 amp, 100 piv	4802-116111	05277	1N4817	REF		
CR4	D5-N5	Diode, silicon, 1 amp, 100 piv	4802-116111	05277	1N4817	REF		
CR5	J1-M5	Diode, zener, 3.9v	4803-113316	07910	1N748	2	1	
CR6	E1-R5	Diode, zener, 6.3v	4803-172148	03877	1N3496	1	1	
CR7	F1-U5	Diode, silicon, 1 amp, 100 piv	4802-116111	05277	1N4817	REF		
CR8	F1-T5	Diode, silicon, 1 amp, 100 piv	4802-116111	05277	1N4817	REF		
CR9	D5-U5	Diode, silicon, 1 amp, 100 piv	4802-116111	05277	1N4817	REF		
CR10	D5-T5	Diode, silicon, 1 amp, 100 piv	4802-116111	05277	1N4817	REF		
P1	C4-Q4	Connector, male, 16 contact	2816-187724	91662	02-016-013- 5-200	REF		
Q1	D5-Q3	Silicon controlled rectifier, 1.6 amp, 50v	4805-192567	03508	C-6F	2	1	
Q2	I4-N4	Tstr, selected, silicon, PNP	4805-159491	89536	4805-159491	REF		
Q3	I5-Q1	Tstr, silicon, NPN	4805-203489	07910	CDQ10656	REF		
Q4	I5-R5	Tstr, silicon, NPN	4805-183004	95303	40250	REF		
Q5	F3-R1	Tstr, silicon, NPN	4805-203489	07910	CDQ10658	REF		
Q6	F3-R5	Tstr, silicon, NPN	4805-203489	07910	CDQ10656	REF		

REF DESIG	INDEX NO	DESCRIPTION	STOCK NO	MFR	MFR PART NO	TOT QTY	REC QTY	USE CODE
Q7	C4-U2	Tstr, silicon, NPN	4805-183004	95303	40250	REF		
Q8	14-T2	Tstr, silicon, NPN	4805-203489	07910	CDQ10656	REF		
Q9	G1-T2	Tstr, silicon, NPN	4805-203489	07910	CDQ10656	REF		
R1	E5-P5	Res, comp, 10k $\pm$ 5%, 1/2w	4704-109165	01121	EB1035	REF		
R2	E5-3	Res, comp, 3900 $\pm$ 5%, 1/2w	4704-109082	01121	EB3915	1		
R3	E5-Q2	Res, comp, 5.6k $\pm$ 5%, 1/2w	4704-187880	01121	EB5625	1		
R4	H3-N3	Res, comp, 15n $\pm$ 10%, 2w	4704-155549	01121	HB1501	1		
R5	11-N5	Res, comp, 15k $\pm$ 10%, 1/2w	4704-108530	01121	EB1531	REF		
RS	J1-P1	Res, comp, 3k +5%, 1/2w	4704-109090	01121	EB3025	REF		
R7	I4-Q4	Res, comp, 33k $\pm$ 10%, 1/2w	4704-178541	01121	EB3331	REF		
R8	G4-R3	Res, met firm, 7.15k $\pm$ 1%, 1/2w	4705-186072	75042	Type CEC-TO	1		
R9	J4-T2	Res, var, ww, 1k $\pm$ 20%, 1-1/4w	4702-113266	71450	Type 110	1		
R10	E2-RI	Res, met flm, 2. 55k $\pm$ 1%, 1/2w	4705-176362	75042	Type CEC-TO	1		
R11	G3-S2	Res, comp, 6. 2k $\pm$ 5%, 1/2w	4704-108621	01121	EB6225	REF		
R12	E2-S1	Res, met flm, 2.37k $\pm$ 1%, 1/2w	4705-182519	75042	Type CEC-TO	1		
R13	G1-S2	Res, comp, 12k $\pm$ 10%, 1/2w	4705-108977	01121	EB1231	1		
R14	G2-V1	Res, comp, 82 $\Omega$ $\pm$ 10%, 2w	4704-110239	01121	HB8201	1		
R15	H4-S4	Res, comp, 8. 2k $\pm$ 5%, 1/2w	4704-147777	01121	EB8225	REF		
R16	H4-T4	Res, comp, 3. 3k $\pm$ 10%, 1/2w	4704-108373	01121	EB3321	1		
R17	H2-T2	Res, comp, 4. 7k $\pm$ 10%, 1/2w	4704-108381	01121	EB4721	2		
R18	E4-S4	Res, met firm, 8. 45k $\pm$ 1%, 1/2w	4705-159475	75042	Type CEC-TO	1		
RI9	E4-T3	Res, met flm, 4. 99k $\pm$ 1%, 1/2w	4705-148890	75042	Type CEC-TO	1		
R20	I5-P3	Res. comp, 2. 0k $\pm$ 5%, 1/2w	4704-169854	01121	EB2025	REF		P

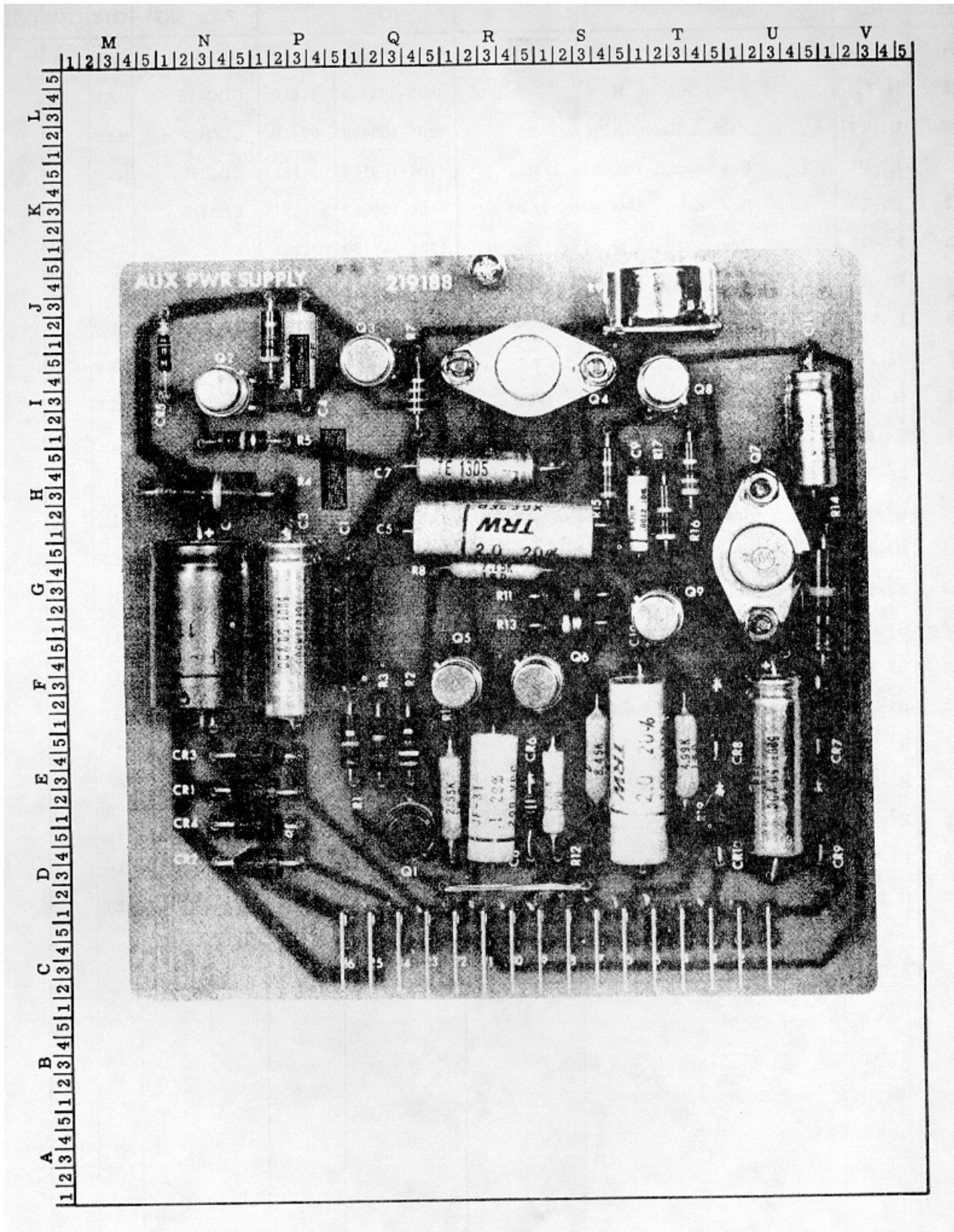

Figure 5-11. AUXILIARY POWER SUPPLY P/C ASSEMBLY

REF DESIG	INDEX NO	DESCRIPTION	STOCK NO	MFR	MFR PART NO	TOT QTY	REC QTY	USE CODE
AS5A		<b>CURRENT LIMITER P/C ASSEMBLY - Figure 5-12</b>	1702-219196 (335A-4060)	89538	1702-219196	REF		
C1	G5-Q2	Cap, elect, 250 uf +50/-10%, 64v	1502-185850	73445	C437ARH250	REF		
C2	13-U2	Cap, elect, 20 uf +75/-10%, 50v	1502-106229	80183	TE1305	REF		
C9	H5-R5	Cap, elect, 20 uf +75/-10%, 50v	1502-106229	80183	TE1305	REF		
C4	H5-85	Cap, elect, 250 uf +50/-10%, 684v	1502-185850	73445	C437ARH250	REF		
C5	J1-U2	Cap, elect, 20 uf +75/-10%, 50v	1502-106229	80183	TE1305	REF		
C6	14-Q2	Cap, elect, 250 uf +50/-10%, 64v	1502-185850	73445	C437ARH250	REF		
C7	H5-N1	Cap, plstc, 0.047 uf ±20%, 100v	1507-106096	72928	335B473M	1		
C9	E2-N3	Cap, elect, 2 uf +75/-10%, 50v	1502-105197	80183	TE 1301	1	1	
C10	E5-Q5	Cap, elect, 160 uf +50/-10%, 64v	1502-170274	73445	C437ARH160	1	1	
CR1	E1-U4	Diode, silicon, 1 amp, 600 piv	4802-112383	05277	1N4822	REF		
CR2	E1-U2	Diode, silicon, 1 amp, 600 piv	4802-112383	05277	1N4822	REF		
CR3	F2-S3	Diode, silicon, 1 amp, 600 piv	4802-112383	05277	1N4822	REF		
CR4	E5-S3	Diode, silicon, 1 amp, 600 piv	4802-112383	05277	1N4822	REF		
CR5	I5-RI	Diode, zener, 36v	4803-186163	07910	IN974B	2	1	
CR6	D3-P1	Diode, zener, 3.9v	4803-113316	07910	1N748	REF		
CR7	J4-T3	Diode, zener, 36v	4803-237354	04713	IN3033A	1	1	
CR8	G1-Q5	Diode, silicon, 1 amp, 600 piv	4802-112383	05277	1N4822	REF		
CR9	12-P1	Diode, zener, 12v	4803-159780	07910	1N759	1	1	
CR10	G2-P3	Diode, silicon, 1 amp, 100 piv	4802-116111	05277	IN4817	REF		
CR11	I1-PI	Diode, silicon, 1 amp, 100 piv	4802-116111	05277	1N4817	REF		
CR12	F5-P3	Diode, silicon, 150 ma, 6 piv	4802-113308	07910	CD13161	REF		
P1	C5-Q4	Connector, male, 16 contact	2816-187724	91662	02-016-013- 5-200	REF		
Q1	G3-S4	Tstr, silicon, NPN	4805-183004	95303	40250	REF		
Q2	G5-U2	Tstr, germanium, PNP	4805-152868	95303	2N2869	1	1	
Q3	J1-N2	Tstr, selected, silicon, PNP	4805-159491	89536	4805-159491	REF		
Q4	HI-N3	Tstr, silicon, NPN	4805-203489	07910	CDQ10656	REF		
Q5	F2-N3	Tstr, selected, silicon, PNP	4805-159491	89536	4805-159491	REF		
Q6	D4-P5	Tstr, selected, silicon, PNP	4805-159491	89536	4805-159491	REF		

REF DESIG	INDEX NO	DESCRIPTION	STOCK NO	MFR	MFR PART NO	TOT QTY	REC QTY	USE CODE
Q7	E4-P5	Tstr, silicon, NPN	4805-203489	07910	CDQ10656	REF		
R1	E5-U2	Res, comp, 10 $\Omega$ $\pm$ 10%, 2w	4704-110163	01121	HB1001	4		
R2	H2-T93	Res, comp, 3. 3k $\pm$ 5%, i/2w	4704-165761	01121	EB3325	REF		
R3	D3-T1	Res, comp, 150 $\pm$ *5%, 2w	4704-235192	01121	HB1515	1		
R4	F3-U2	Res, comp, 100 $\pm$ 10%, 2w	4704-110163	01121	HB1001	REP		
R5	15-R3	Res, comp, 3.3k $\pm$ 5%, 1/2w	4704-165761	01121	EB3325	REF		
R6	D3-P2	Res, comp, 7. 5k $\pm$ 5%, 1/2w	4704-108910	01121	EB7525	3		
R7	H5-RI	Res, comp, 100k $\pm$ 10%, 1/2w	4704-108126	01121	EB1041	REF		
R8	F5-R4	Res, comp, 120 $\Omega$ $\pm$ 10%, 2w	4704-155531	01121	HB1211	4		
R9	E1-TI	Res, comp, 120 $\Omega$ $\pm$ *10%, 2w	4704-155531	01121	HB1211	REF		
R10	E2-Q1	Res, comp, 4. 7k $\pm$ 10%, 1/2w	4704-108381	01121	EB4721	REF		
R11	F1-P3	Res, comp, 10k $\pm$ 10%, 1/2w	4704-108118	01121	EB 1031	REF		
R12	D3-N4	Res, comp, 10k $\pm$ 10%, 1/2w	4704-108118	01121	EB1031	REF		
R13	D3-N1	Res, comp, 16k $\pm$ 5%, 1/2w	4704-159632	01121	EB1635	REF		
R14	D3-N2	Res, comp, 1k $\pm$ 10%, 1/2w	4704-108563	01121	EB1021	REF		
R15	13-PI	Res, comp, 2. 2k $\pm$ 10%, 1/2w	4704-108605	01121	EB2221	1		
R16	G2-N4	Res, comp, 100k $\pm$ 10%, 1/2w	4704-108126	01121	EB1041	REF		
R17	H4-P1	Res, comp, 36k $\pm$ 5%, 1/2w	4704-185991	01121	EB3635	REF		
RIB	G2-N3	Res, comp, 330k $\pm$ 5%, 1/2w	4704-150201	01121	EB3345	1		
R19	G2-Q5	Res, comp, 7. 5k $\pm$ 5%, 1/2w	4704-108910	01121	EB7525	REF		
R20	F4-P3	Res, comp, 7. 5k $\pm$ 5%, 1/2w	4704-108910	01121	EB7525	REF		
R21	F2-P3	Res, comp, 1k $\pm$ 10%, 1/2w	4704-108563	01121	EB1021	REF		
R22	J3-P1	Res, met flm, 12. 1k $\pm$ 1%, 1/2w	4705-182535	75042	Type CEC-TO	1		
R23	J5-N2	Res, var, ww, 10k +10%, 1-1/4w	4702-162115	71450	Type 110	1		
R24	J4-U3	Res, var, ww, 150 $\Omega$ $\pm$ 10%, 1-1/4w	4702-113092	71450	Type 110	1		
R25	E3-T2	Res, comp, 120 $\Omega$ $\pm$ 10%, 2w	4704-155531	01121	HB1211	REF		
R26	E2-R4	Res, comp, 120 $\Omega$ $\pm$ 10%, 2w	4704-155531	01121	HB1211	REF		
	F5-82	Heat sink	4806-186759	89536	4806-186759	REF		
	H4-V1	Heat sink	4806-186742	89536	4806-186742	1		

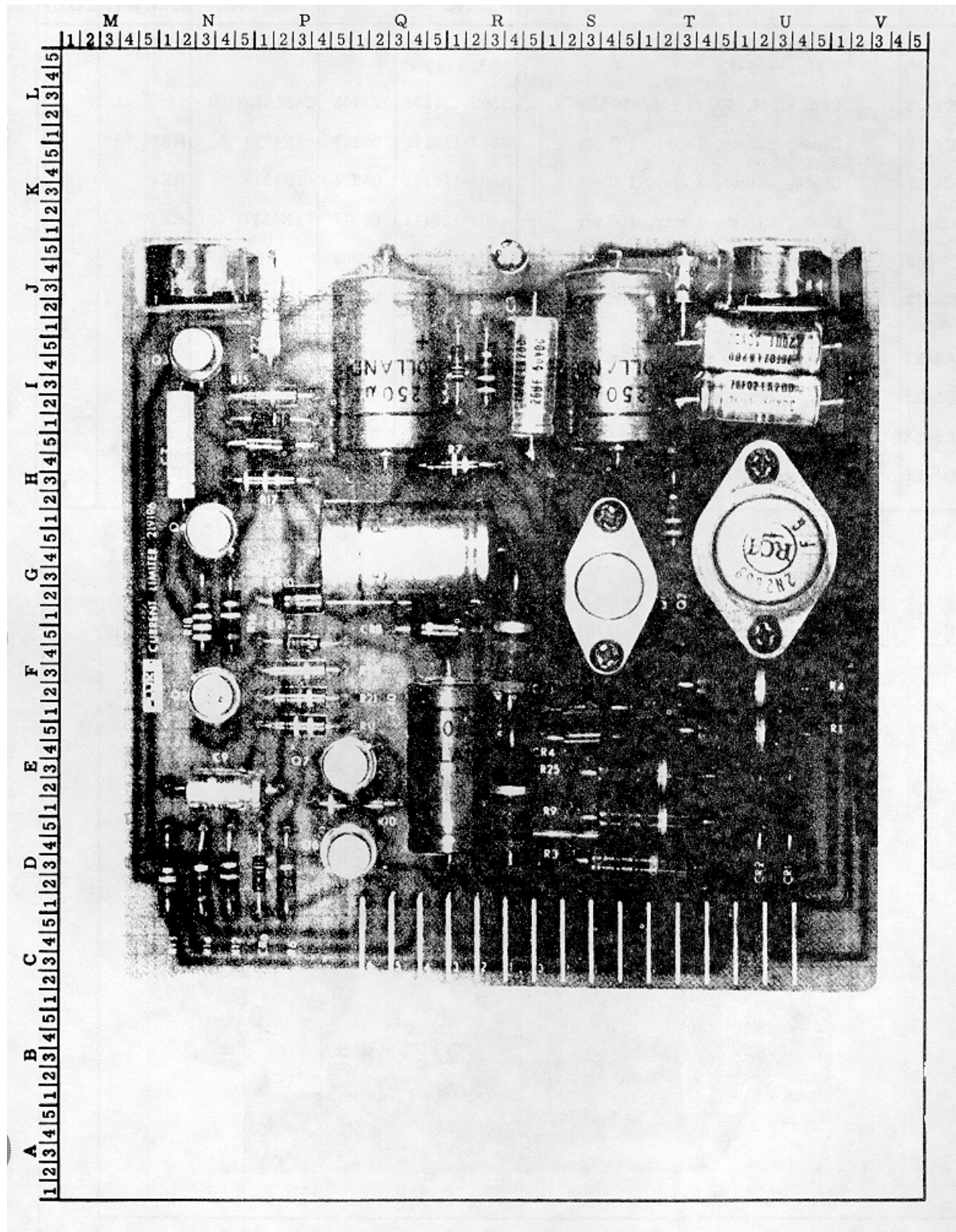

Figure 5-12. CURRENT LIMITER SUPPLY P/C ASSEMBLY



REF DESIG	INDEX NO	DESCRIPTION	STOCK NO	MFR	MFR PART NO	TOT QTY	REC QTY	USE CODE
A6		<b>TIME DELAY P/C ASSEMBLY FIGURE 5-13</b>	1702-192260 (332A-420)	89536	1702-192260	REF		
C2001	E1-J3	Cap, elect, 400 uf +50/-10%, 40v	1502-185868	73445	C437ARG400	1	1	
CR2001	C4-I3	Diode, silicon, 1 amp, 100 piv	4802-116111	05277	1N4817	REF		
CR2002	C1-I5	Diode, silicon, 1 amp, 100 piv	4802-116111	05277	1N4817	REF		
CR2003	C5-I1	Diode, silicon, 1 amp, 100 piv	4802-116111	05277	1N4817	REF		
K2001	C2-M2	Relay, Armature, 12 vdc, dpdt	4504-176347	80089	62-760	1		
Q2001	E4-M2	Silicon controlled rectifier, 1.6 amp, 50v	4805-192567	03508	C-6F	REF		
R2001	A5-K5	Res, comp, 2.2k ±10%, 2w	4704-109967	01121	HB2221	2		
R2002	E3-K3	Res, comp, 5.6k ±10%, 1/2w	4704-108324	01121	EB5621	1		
R2003	F2-L3	Res, comp, 390Ω ±10%, 1/2w	4707-108365	01121	EB3911	1		
R2004	D4-K5	Res, comp 10k ±10%, ½w	4704-108118	01121	EB1031	REF		

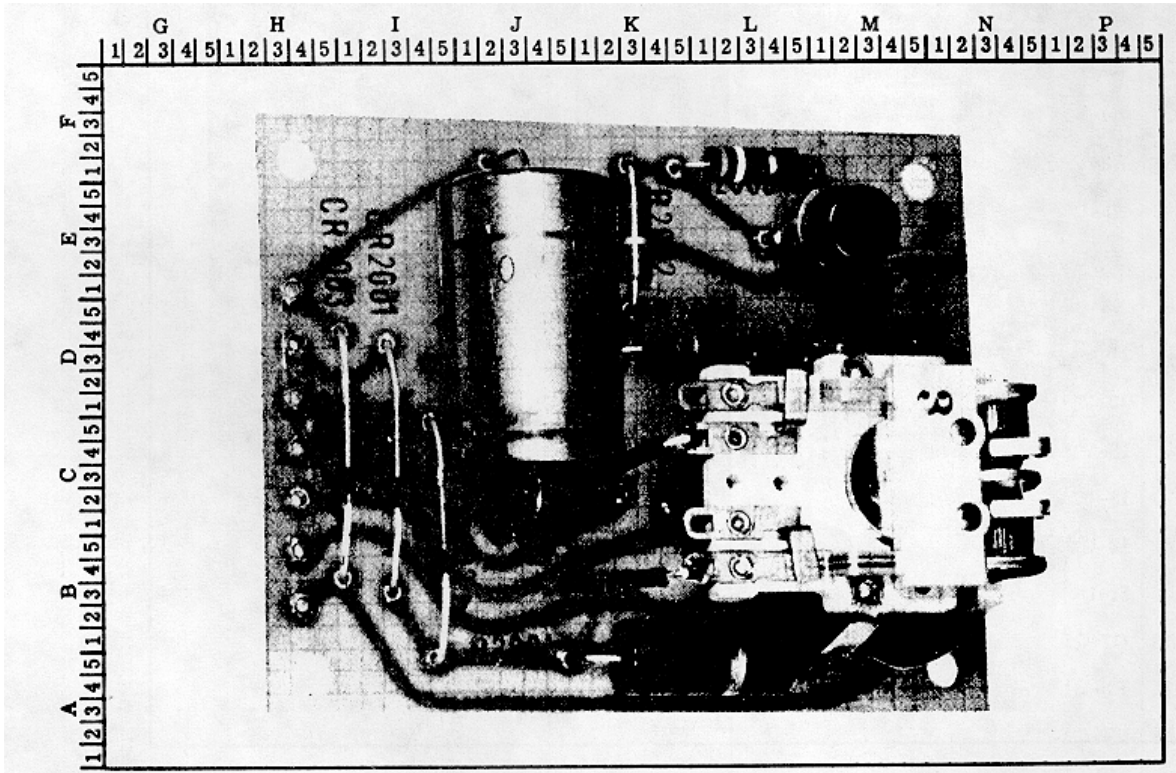

Figure 5-13. TIME DELAY P/C ASSEMBLY

REF DESIG	INDEX NO	DESCRIPTION	STOCK NO	MFR	MFR PART NO	TOT QTY	REC QTY	USE CODE
A7		<b>HIGH VOLTAGE MOTHER BOARD</b>	1702-239350	89536	1702-23S950	REF		
A7A1		<b>P/C ASSEMBLY - Figure 5-14</b>	(332B-4056)					
		Series Pass Element P/C Assembly	1702-219204	89536	1702-219204	REF		
		(See Figure 5-15)	(33S5A-4061)					
A7TA		Preregulator P/C Assembly	1702-222000	89536	1702-222000	REF		
		(See Figure 5-16)	(335A-4082)					
C1	E4-N4	Cap, elect, 125 uf +50/-10%, 450v	1502-106336	56289	Type 66D	3	1	
C2	G4-N4	Cap, elect, 125 uf +50/-10%, 450v	1502-106336	56289	Type 66D	REF		
C3	12-N4	Cap, elect, 125 uf +50/-10%, 450v	1502-106336	56289	Type 66D	REF		
C4	E1-S84	Cap, elect, 8 uf +50/-10%, 450v	1502-194068	56289	39D805F450H-	3		
					E4			
C5	E2-Q1	Cap, elect, 8 uf +50/-10%, 450v	1502-194068	56289	39D805F450H-	REF		
					E4			
C6	F5-T3	Cap, plstc, 1 uf ±20%, 200v	1507-106450	84411	Type X663F	2		
C7	H5-Q5	Cap, elect, 50 uf +75/-10%, 50v	1502-105122	80183	TE1307	REF		
C8	I1-Q3	Cap, cer, 0.001 uf *20%, 3 kv	1501-105635	80183	29C300	1		
C9	F2-T4	Cap, cer, 0.01 uf, gm, 1600v	1501-106930	71590	DD16-103	REF		G
C10	H5-82	Cap, oil, 3 uf ±20%, 230v	1505-185926	56289	200P1640	1		
CR1	H5-V1	Diode, silicon, 1 amp, 600 piv	4802-112383	05277	1N4822	REF		
CR	H4-V1	Diode, silicon, 1 amp, 600 piv	4802-112383	05277	1N4822	REF		
CR3	H3-V1	Diode, silicon, 1 amp, 600 piv	4802-112383	05277	1N4822	REF		
CR4	H3-U2	Diode, silicon, 1 amp, 600 piv	4802-112383	05277	1N4822	REF		
CRS	H4-U2	Diode, silicon, 1 amp, 600 piv	4802-112383	05277	1N4822	REF		
CR6	H5-U2	Diode, silicon, 1 amp, 600 piv	4802-112383	05277	1N4822	REF		
CRI	I1-V1	Diode, silicon, 1 amp, 600 piv	4802-112383	05277	1N4822	REF		
CR8	I2-V1	Diode, silicon, 1 amp, 600 piv	4802-112383	05277	1N4822	REF		
CR9	I3-V1	Diode, silicon, 1 amp, 600 piv	4802-112383	05277	1N4822	REF		
CR10	I3-U2	Diode, silicon, 1 amp, 600 piv	4802-112383	05277	1N4822	REF		
CR11	I2-U2	Diode, silicon, 1 amp, 600 piv	4802-112383	05277	1N4822	REF		
CR12	I1-U2	Diode, silicon, 1 amp, 600 piv	4802-112383	05277	1N4822	REF		
CR13	G1-Q1	Diode, silicon, 1 amp, 600 piv	4802-112383	05277	1N4822	REF		
CR14	F5-Q1	Diode, silicon, 1 amp, 600 piv	4802-112383	05277	1N4822	REF		
CR15	F4-Q1	Diode, silicon, 1 amp, 600 piv	4802-112383	05277	1N4822	REF		

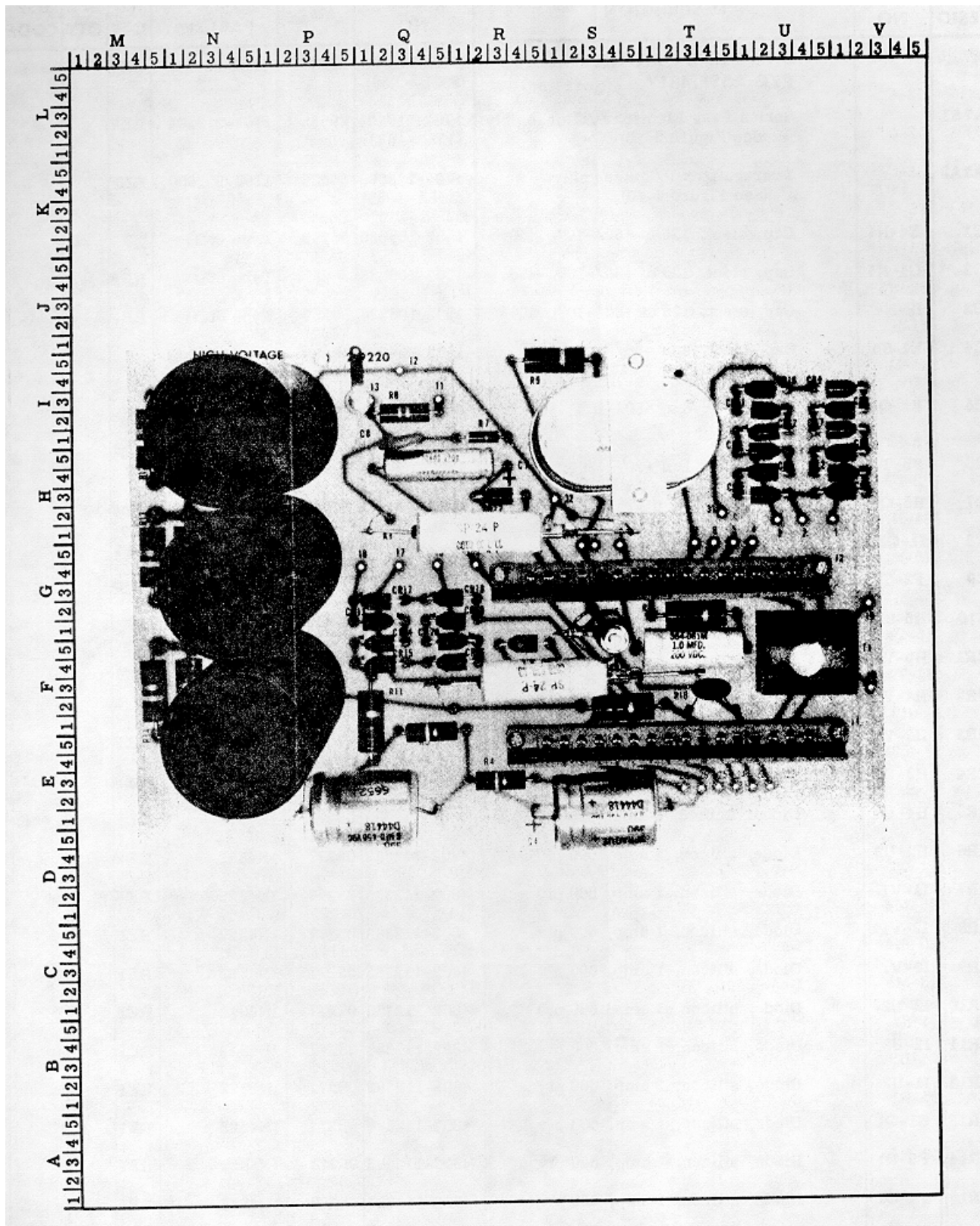









Figure 5-14. HIGH VOLTAGE MOTHER BOARD P/C ASSEMBLY

REF DESIG	INDEX NO	DESCRIPTION	STOCK NO	MFR	MFR PART NO	TOT QTY	REC QTY	USE CODE
CR16	F4-Q5	Diode, silicon, 1 amp, 600 piv	4802-112383	05277	1N4822	REF		
CR17	G2-Q1	Diode, silicon, 1 amp, 600 piv	4802-112383	05277	1N4822	REF		
CR18	G2-Q5	Diode, silicon, 1 amp, 600 piv	4802-112383	05277	1N4822	REF		
CR19	G1-Q5	Diode, silicon, 1 amp, 600 piv	4802-112383	05277	1N4822	REF		
CR20	F5-Q5	Diode, silicon, 1 amp, 600 piv	4802-112383	05277	1N4822	REF		
CR21	F5-R4	Diode, silicon, 1 amp, 100 piv	4802-116111	05277	IN4817	REF		
CR22	H3-R3	Diode, silicon, 1 amp, 100 piv	4802-116111	05277	IN4817	REF		
K1	H1-S1	Relay, reed, 5,000v	5103-184440	12617	DRV1-1	2		
	H1-R2	Coil, reed relay, 24v	1802-186155	71707	8P-24-P	REF		
K2	F3-S4	Relay, reed, 5, 000v	5103-184440	12617	DRV1-1	REF		
	F3-S1	Coil, reed relay, 24v	1802-186155	71707	SP-24-P	REF		
R1	F2-N1	Res, comp, 220k $\pm$ 10%, 2w	4704-110197	01121	HB2241	6		
R2	G4-N1	Res, comp, 220k $\pm$ 10%, 2w	4704-110197	01121	HB2241	REF		
R3	H5-N1	Res, comp, 220k $\pm$ 10%, 2w	4704-110197	01121	HB2241	REF		
R4	ES-R3	Res, comp, 470k $\pm$ 5%, 1w	4704-109819	01121	GB4745	2		
R5	E5-Q4	Res, comp, 470k $\pm$ 5%, 1w	4704-109819	01121	GB4745	REF		
R6	G1-T3	Res, comp, 10 $\Omega$ $\pm$ 10%, 2w	4704-110163	01121	HB1001	REF		
R7	11-R2	Res, comp, 470 $\Omega$ $\pm$ 10%, 1/2w	4704-108415	01121	EB4711	REF		
PR	13-Q2	Res, comp, 5. 1 $\Omega$ $\pm$ 5%, 1w	4704-219071	01121	GB51G5	1		
R9	15-S1	Res, comp, 10 $\Omega$ 1096, 2w	4704-110163	01121	HB1001	REF		
R10	F1-S4	Res, comp, 270 $\Omega$ $\pm$ 10%, 2w	4704-110189	01121	HB2711	1		
R11	F11-Q1	Res, comp, 2.2k $\pm$ 10%, 2w	4704-109967	01121	HB2221	REF		
R12	H5-M4	Res, comp, 220k $\pm$ 10%, 2w	4704-110197	01121	HB2241	REF		
R13	G5-M4	Res, comp, 220k $\pm$ 10%, 2w	4704-110197	01121	HB2241	REF		
R14	F3-M4	Res, comp, 220k $\pm$ 10%, 2w	4704-110197	01121	HB2241	REF		
R15	G1-S4	Res, ww, 2k $\pm$ 5%, 10w	4706-155416	06136	Type 10F	1		
T1	F4-U5	Transformer, pulse	5600-185827	89536	5600-185827	1		
XA7A1	E5-R5	Connector, female, 16 contact	2107-187732	91662	00-5009-016-153-001	REF		
XA7A2	G3-R4	Connector, female, 16 contact	2107-187732	91662	00-5009-01-153-001	REF		

REF DESIG	INDEX NO	DESCRIPTION	STOCK NO	MFR	MFR PART NO	TOT QTY	REC QTY	USE CODE
A7A1		<b>SERIES PASS ELEMENT P/C ASSEMBLY - Figure 5-15</b>	1702-219204 (335A-4061)	89536	1702-219204	REF		
C1	E4-Q5	Cap, cer, 0.05 uf +80/-10%, 500v	1501-105676	56289	33C58B	6		
C2	DS-T1	Cap, elect, 8 uf +50/-10%, 450v	1502-194068	56289	39D805F450- HE4	REF		
C3	G1-R4	Cap, cer, 0.05 uf +80/-10%, 500v	1501-105676	56289	33C58B	REF		
C4	DS-P4	Cap, plstc, 0.068 uf ±10%, 100v	1507-182170	88419	DMF1S68	1		S
C5	D5-P2	Cap, plstc, 0.047 uf ±10%, 80v	1507-195099	56289	192P4739R8	1		
CR1	D4-R2	Diode, silicon, 1 amp, 600 piv	4802-112383	05277	1N4822	REF		
CR2	D4-91	Diode, silicon, 1 amp, 600 piv	4802-112383	05277	1N4822	REF		
CR3	D4-R1	Diode, silicon, 1 amp, 600 piv	4802-112383	05277	1N4822	REF		
CR4	D4-R4	Diode, silicon, 1 amp, 600 piv	4802-112383	05277	1N4822	REF		
CR5	D4-82	Diode, silicon, 1 amp, 600 piv	4802-112383	05277	1N4822	REF		
CR6	D5-Q3	Diode, zener, 6. 8v	4803-187195	07910	CD36554	1	1	
CR7	G1-N2	Diode, silicon, 1 amp, 600 piv	4802-112383	05277	1N4822	REF		
CR8	G1-M5	Diode, silicon, 1 amp, 600 piv	4802-112383	05277	1N4822	REF		
CR9	G2-N5	Diode, silicon, 1 amp, 600 piv	4802-112383	05277	1N4822	REF		
CR10	G2-P1	Diode, silicon, 1 amp, 600 piv	4802-112383	05277	1N4822	REF		
CR1	H2-Q4	Diode, silicon, 1 amp, 600 piv	4802-112383	05277	1N4822	REF		
CR12	G2-Q2	Diode, silicon, 1 amp, 600 piv	4802-112383	05277	1N4822	REF		
CR13	G5-95	Diode, silicon, 1 amp, 600 piv	4802-112383	05277	1N4822	REF		
CR14	G4-82	Diode, silicon, 1 amp, 600 piv	4802-112383	05277	1N4822	REF		
CR15	H2-R5	Diode, silicon, 1 amp, 600 piv	4802-112383	05277	1N4822	REF		
CR16	G4-T3	Diode, silicon, 1 amp, 600 piv	4802-112383	05277	1N4822	REF		
CR17	G4-U4	Diode, silicon, 1 amp, 600 piv	4802-112383	05277	1N4822	REF		
CR18	D5-Q5	Diode, zener, 20v	4803-113340	07910	1N96A	1	1	
CR19	F5-R5	Diode, zener, 36v	4803-186163	07910	1N974B	REF		
CR20	D5-Q2	Diode, silicon, 1 amp, 100 piv	4802-116111	05277	1N4817	REF		
CR21	C3-V1	Diode, silicon, 1 amp, 100 piv	4802-116111	05277	1N4817	REF		
CR22	C4-U3	Diode, zener, 6. 2v	4803-180497	07910	1N753	1	1	
CR23	F4-Q1	Diode, zener, 200v	4803-217422	04713	1N3051A	8	1	
CR24	J1-N1	Diode, zener, 200v	4803-217422	04713	1N3051A	REF		

REF DESIG	INDEX NO	DESCRIPTION	STOCK NO	MFR	MFR PART NO	TOT QTY	REC QTY	USE CODE
CR25	J1-P2	Diode, zener, 200v	4803-217422	04713	1N3051A	REF		
CR26	J1-Q2	Diode, zener, 200v	4803-217422	04713	IN3051A	REF		
CR27	J1-R3	Diode, zener, 200v	4803-217422	04713	IN3051A	REF		
CR28	J1-83	Diode, zener, 200v	4803-217422	04713	IN3051A	REF		
CR29	J1-T4	Diode, zener, 200v	4803-217422	04713	1N3051A	REF		
CR30	J1-U5	Diode, zener, 200v	4803-217422	04713	IN3051A	REF		
CR31	F2-S4	Diode, silicon, 1 amp, 600 piv	4802-112383	05277	1N4822	REF		
CR32	D5-P1	Diode, silicon, 1 amp, 100 piv	4802-116111	05277	IN4817	REF		
P1	C3-P1	Connector, male, 16 contact	2816-187724	91662	02-016-013- 5-200	REF		
Q1	I5-M5	Tstr, silicon, NPN				8	8	
Q2	I5-P1	Tstr, silicon, NPN				REF		
Q3	I5-P1	Tstr, silicon, NPN				REF		
Q4	I5-R3	Tstr, silicon, NPN				REF		
Q5	I5-S3	Tstr, silicon, NPN				REF		
Q6	I5-T4	Tstr, silicon, NPN				REF		
Q7	I5-U5	Tstr, silicon, NPN				REF		
Q8	E3-U3	Tstr, silicon, NPN				REF		
Q9	D1-N2	Tstr, silicon, unijunction	4805-117176	03508	2N1671A	1	1	
Q10	C4-T4	Tstr, silicon, NPN	4805-203489	07910	CDQ10656	REF		
R1	F2-Q1	Res, comp, 1.8k $\pm$ 10%, 2w	4704-185983	01121	HB1821	3		
R2	F3-N4	Res, comp, 1.8k $\pm$ 10%, 2w	4704-185983	01121	HB1821	REF		
R3	E5-N4	Res, comp, 1.8k $\pm$ 10%, 2w	4704-185983	01121	HB1821	REF		
R4	C4-U2	Res, comp, 360 $\Omega$ $\pm$ 5%, 1/2w	4704-192559	01121	EB3615	REF		H
R4	C4-U2	Res, comp, 62k $\pm$ 5%, 1/2w	4704-108522	01121	EB6235	2		I
R5	F1-R5	Res, comp, 270k $\pm$ 10%, 2w	4704-110023	01121	HB2741	1		H
R5	F1-R5	Res, comp, 100k $\pm$ 10%, 2w	4704-158659	01121	HB1041	1		I
R6	H2-N3	Res, comp, 56k $\pm$ 5%, 1/2w	4704-219048	01121	EB5635	1		
R7	H2-M5	Res, comp, 1k $\pm$ 5%, 1/2w	4704-108597	01121	EB1025	REF		
R8	H2-P1	Res, comp, 62k $\pm$ 5%, 1/2w	4704-108522	01121	EB6235	REF		
R9	H2-P3	Res, comp, 1k $\pm$ 5%, 1/2w	4704-108597	01121	EB1025	REF		
R10	H2-Q1	Res, comp, 68k $\pm$ 5%, 1/2w	4704-159624	01121	EB6835	1		
R11	H2-Q2	Res, comp, 1k $\pm$ 5%, 1/2w	4704-108597	01121	EB1025	REF		

REF DESIG	INDEX NO	DESCRIPTION	STOCK NO	MFR	MFR PART NO	TOT QTY	REC QTY	USE CODE
R12	H2-R4	Res, comp, 75k $\pm$ 5%, 1/2w	4704-108928	01121	EB7535	REF		
R13	H2-R2	Res, comp, 1k $\pm$ 5%, 1/2w	4704-108597	01121	EB1025	REF		
R14	H2-S5	Res, comp, 82k $\pm$ 5%, 1/2w	4704-195966	01121	EB8235	1		
R15	H3-S5	Res, comp, 1k $\pm$ 5%, 1/2w	4704-108597	01121	EB1025	REF		
R16	H2-T5	Res, comp, 91k $\pm$ 5%, 1/2w	4704-219030	01121	EB9135	1		
R17	H2-T3	Res, comp, 1k $\pm$ 5%, 1/2w	4704-108597	01121	EB1025	REF		
R18	H5-U4	Res, comp, 100k $\pm$ 5%, 1/2w	4704-168054	01121	EB1045	9		
R19	H3-U4	Res, comp, 1k $\pm$ 5%, 1/2w	4704-108597	0112i	EB1025	REF		
R20	C4-U5	Res, comp, 1.1 $\Omega$ $\pm$ 5%, 1/2w	4704-163717	01121	EB11G5	1		
R21	H2-N5	Res, comp, 100k $\pm$ 5%, 1/2w	4704-168054	01121	EB1045	REF		
R22	H2-P4	Res, comp, 100k $\pm$ 5%, 1/2w	4704-168054	01121	EB1045	REF		
R23	H2-Q5	Res, comp, 100k $\pm$ 5%, 1/2w	4704-168054	01121	EB1045	REF		
R24	H2-S2	Res, comp, 100k +5%, 1/2w	4704-168054	01121	EB1045	REF		
R25	H5-S5	Res, comp, 100k $\pm$ 5%, 1/2w	4704-168054	01121	EB1045	REF		
R26	G5-U4	Res, comp, 100k $\pm$ 5%, 1/2w	4704-168054	01121	EB1045	REF		
R27	H2-U4	Res, comp, 100k $\pm$ 5%, 1/2w	4704-168054	01121	EB1045	REF		
R28	G1-P3	Res, comp, 22k $\pm$ 10%, 2w	4704-109975	01121	HB2231	7		
R29	G4-Q3	Res, comp, 22k $\pm$ 10%, 2w	4704-109975	01121	HB2231	REF		
R30	F5-Q3	Res, comp, 22k $\pm$ 10%, 2w	4704-109975	01121	HB2231	REF		
R31	G2-S5	Res, comp, 22k $\pm$ 10%, 2w	4704-109975	01121	HB2231	REF		
R32	F5-S5	Res, comp, 22k $\pm$ 10%, 2w	4704-109975	01121	HB2231	REF		
R33	F4-U3	Res, comp, 22k $\pm$ 10%, 2w	4704-109975	01121	HB2231	REF		
R34	G1-U3	Res, comp, 22k $\pm$ 10%, 2w	4704-109975	01121	HB2231	REF		
R35	F3-Q5	Res, comp, 75k $\pm$ 5%, 1/2w	4704-108928	01121	EB7535	REF		
R36	F5-R3	Res, comp, 75k $\pm$ 5%, 1/2w	4704-108928	01121	EB7535	REF		
R37	E1-N2	Res, comp, 36k $\pm$ 5%, 1/2w	4704-185991	01121	EB3635	REF		
R38	D4-P5	Res, comp, 180 $\Omega$ $\pm$ 5%, 1/2w	4704-108944	01121	EB1815	2		
R39	E1-M5	Res, comp, 100 $\Omega$ $\pm$ 5%, 1/2w	4704-188508	01121	EB1015	REF		
R40	H2-N2	Res, comp, 100k $\pm$ 5%, 1/2w	4704-168054	01121	EB1045	REF		
R41	E3-N5	Res, met flm, 4.75k $\pm$ 1%, 1/2w	4705-192500	75042	Type CEC-TO	2		S

REF DESIG	INDEX NO	DESCRIPTION	STOCK NO	MFR	MFR PART NO	TOT QTY	REC QTY	USE CODE
R42	E3-N3	Res, met flm, 4.75k $\pm$ 1%, 1/2w	4705-192500	75042	Type CEC-TO	REF		S
	E1-V1	Heat sink	4806-192245	89536	4806-192245	1		

5

Q1 thru QS may be Fluke Part No. 4805-190710, Mfr 04713, Mfr Part No. 2N3739; or Fluke Part No. 480-225573, Mfr 95303, Mfr Part No. 2N4299. It is necessary, however, that all eight must be the same type. Example; if all eight are 2N4299, a replacement one or more should be a 2N4299.



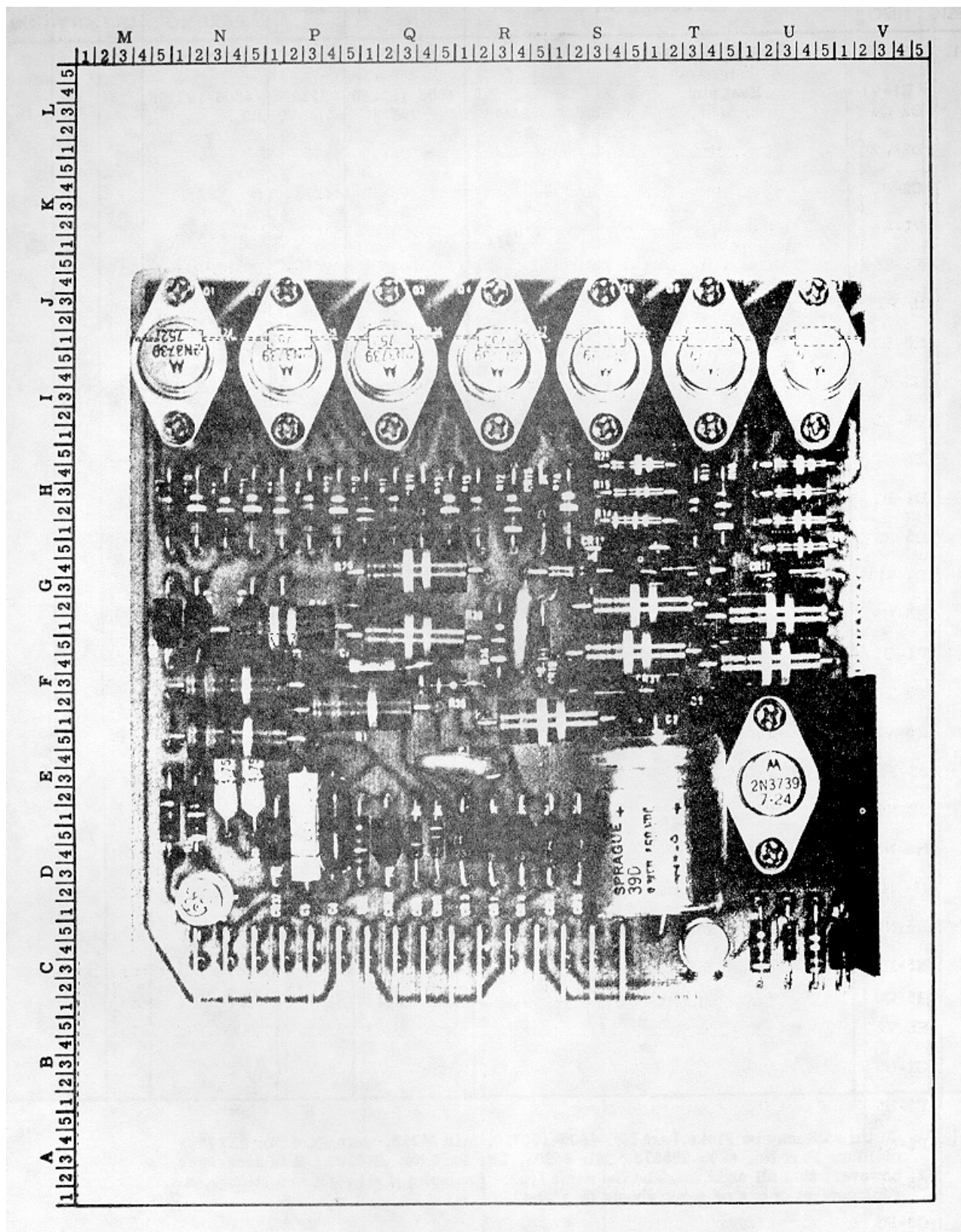

Figure 5-15. SERIES PASS ELEMENT P/C ASSEMBLY

REF DESIG	INDEX NO	DESCRIPTION	STOCK NO	MFR	MFR PART NO	TOT QTY	REC QTY	USE CODE
A7A2		<b>PREREGULATOR P/C ASSEMBLY</b> <b>Figure 5-16</b>	1702-222000 (335A-4082)	89536	1702-222000	REF		
C1	D2-Q4	Cap, cer, 0.05 uf +80/-10%, 500,	1501-105676	56289	33C58B	REF		
C2	D3-Q2	Cap, cer, 0.05 uf +80/-10%, 500v	1501-105676		56289	33C58B	REF	
C3	E2-P5	Cap, plstc, 1 uf ± 20%, 200v	1507-106450	84411	Type X663F	REF		
C4	F2-R4	Cap, elect, 1,000 uf +50/-10%, 16v	1502-193896	73445	C437ARE1000	1		
C5	E4-33	Cap, cer, 0.05 uf +80/-10%, 500v	1501-105676	56289	33C58B	REF		
C6	15-P5	Cap, cer, 0.05 uf +80/-10%, 500v	1501-105676	56289	33C58B	REF		
C7	GS-PI	Cap, cer, 0.01 uf +80/-20%, 500v	1501-105668	80183	29C9B5	1		
C8	G5-R3	Cap, mica, 510 pf ±5%, 500v	1504-148411	88419	CD19F511J	REF		
CR1	D3-P2	Diode, silicon, 1 amp, 100 piv	4802-116111	05277	IN4817	REF		
CR2	E4-R2	Diode, silicon, 3 amp, 200 piv	4802-187716	04713	MROS32B	7	1	
CR3	D1-P2	Diode, silicon, 1 amp, 100 piv	4802-116111	05277	IN4817	REF		
CR4	DS-R3	Diode, silicon, 3 amp, 200 piv	4802-187716	04713	MR1032B	REF		
CR5	E1-S1	Diode, silicon, 3 amp, 200 piv	4802-187716	04713	MR1032B	REF		
CR6	HS-U5	Diode, silicon, 1 amp, 600 piv	4802-112383	05277	1N4822	REF		
CR7	FI-U1	Diode, silicon, 1 amp, 600 piv	4802-112383	05277	1N4822	REF		
CR8	F5-T5	Diode, silicon, 1 amp, 600 piv	4802-112383	05277	1N4822	REF		
CR9	H5-V2	Diode, silicon, 1 amp, 600 piv	4802-112383	05277	1N4822	REF		
CR10	J3-P3	Diode, silicon, 3 amp, 200 piv	4802-187716	04713	MR1032B	REF		
CR11	J2-N4	Diode, silicon, 3 amp, 200 piv	4802-187716	04713	MR1032B	REF		
CR12	H5-N5	Diode, silicon, 3 amp, 200 piv	4802-187716	04713	MR1032B	REF		
CR13	14-N4	Diode, silicon, 3 amp, 200 piv	4802-187716	04713	MR1032B	REF		
CR14	D5-N3	Diode, zener, 200v	4803-187617	04713	IN3350RA	1	1	
CR15	H5-P5	Diode, silicon, 1 amp, 100 piv	4802-116111	05277	IN4817	REF		
CR16	H5-Q5	Diode, silicon, 1 amp, 100 piv	4802-116111	05277	IN4817	REF		
K1	H5-T5	Relay, armature, 115 vac, dpdt	4501-106864	16332	100-5ADPDT	1		
K2	G2-U5	Relay, reed, 500v	5103-136630	12617	Type DRG-1	1		
	F2-U5	Coil, reed relay, 24v	1802-186155	71707	SP-24-P	REF		
L1	F5-Q1	Inductor, 1,000 uh, 140 ma	1801-147819	72559	WEE-1,000	1		
L2	G5-81	Inductor, 220 uh, 280 ma	1801-147835	72559	WEE-220	1		
P1	C3-P3	Connector, male, 16 contact	2816-187724	91662	02-016-013- 5-200	REF		

REF DESIG	INDEX NO	DESCRIPTION	STOCK NO	MFR	MFR PART NO	TOT QTY	REC QTY	USE CODE
Q1	H3-N3	Tstr, silicon, NPN	4805-193953	05277	320C034H31	1	1	
Q2	H1-P3	Tstr, silicon, NPN	4805-183004	95303	40250	REF		
Q3	14-R4	Tstr, tested, silicon, PNP	4805-159491	89536	4805-159491	REF		
Q4	G2-T1	Tstr, tested, silicon, PNP	4805-159491	89536	4805-159491	AEF		
Q5	H1-R1	Tstr, silicon, NPN	4805-203489	07910	CDQ10656	REF		
Q6	F1-Q3	Tstr, tested, silicon, PNP	4805-159491	89566	4805-159491	REF		
Q7	F2-P4	Tstr, silicon, NPN	4805-203489	07910	CDQ10656	REF		
R1	D5-P4	Res, comp, 68Ω ±10%, 2w	4704-110205	01121	HB6801	1		
R2	J1-R1	Res, ww, 0.192Ω ±1%, 3w	4707-238741	89536	4707-238741	1	1	
R4	J3-V1	Res, ww, 2k5%, 5w	4706-113506	06136	Type5F	1		
R5	14-P4	Res, comp, 22k ±5%, 1/2w	4704-186064	01121	EB2235	REF		
R6	E1-U1	Res, ww, 10Ω ±10%, 5w	4706-112300	06136	Type 10F	2		
R7	D1-U1	Res, ww, 10Ω ±10%, 5w	4706-112300	06136	Type 10F	REF		
R8	12-Q3	Res, comp, 430Ω ±15, 5% 1/2w	4704-109058	01121	EB4315	1		Q
R8	12-Q3	Res, comp, 560Ω ±5%, 1/2w	4704-109124	01121	EB5615	1		R
R9	J1-Q1	Res, comp, 360Ω ±5%, 1/2w	4704-192559	01121	EB3615	REF		
R10	F5-N5	Res, comp, 20k ±5%, 1/2w	4704-109041	01121	EB2035	REF		
R11	12-S1	Res, comp, 100Ω ±5%, 1/2w	4704-188508	01121	EB1015	REF		
R12	H2-T1	Res, comp, 1k±5%, 1/2w	4704-108597	01121	EB1025	REF		
R13	H5-S2	Res, comp, 270Ω ±5%, 1/2w	4704-159616	01121	EB2715	2		
R14	G1-P3	Res, comp, 180Ω ±5%, 1/2w	4704-108944	01121	EB1815	REF		
R15	G1-S1	Res, comp, 4.7k ±5%, 1/2w	4704-108886	01121	EB4725	1		
R16	E5-N5	Res, comp, 3.3k ±5%, 1/2w	4704-165761	01121	EB3325	REF		
R17	G3-R5	Res, comp, 270Ω ±5%, 1/2w	4704-159616	01121	EB2715	REF		
R18	H2-S1	Res, comp, 62012i5%, 1/2w	4704-108704	01121	EB6215	REF		
	D4-T1	Heat sink	3156-227256	89536	3156-227256	1		
	F1-N1	Heat sink	4806-186767	89536	4806-186767	1		

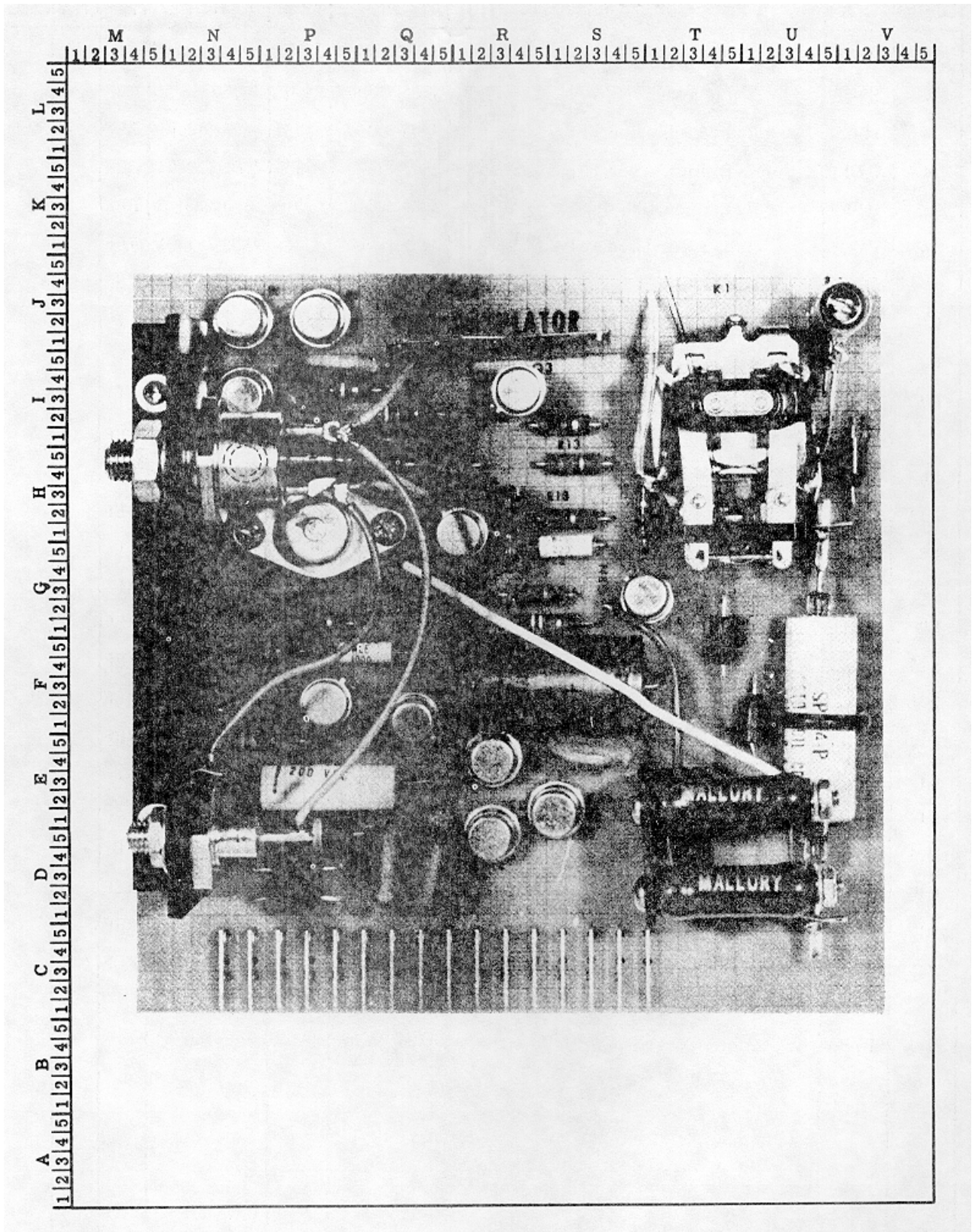

Figure 5-16. PREREGULATOR P/C ASSEMBLY

## Federal Supply Code for Manufacturers

## A-1. CODE TO NAME

A-2. The following five-digit code numbers are listed in numerical sequence along with the manufacturer's

name and address to which the code has been assigned. The Federal Supply Code has been taken from Cataloging Handbook H 4-2, Code to Name.

00213	Sage Electronics Corp. Rochester, New York	04009	Arrow Hart and Hegemen Electronic Company Hartford, Connecticut	06739	Electron Corp. Littletown, Colorado	11358	CBS Electronics Div. of CBS Inc. Newburyport, Massachusetts
00327	Welwyn International, Inc. Westlake, Ohio	04062	Replaced by 72136	06743	Clevite Corp. Cleveland, Ohio	11403	Best Products Co. Chicago, Illinois
00656	Aerovox Corp. New Bedford, Massachusetts	04202	Replaced by 81312	06751	Semcor Div. Components Phoenix, Arizona	11503	Keystone Mfg Div. of Avis Industrial Corp. Warren, Michigan
00779	AMP Inc. Harrisberg, Pennsylvania	04217	Essex Wire Corp Wire & Cable Div. Anaheim, California	08680	Gould National Batteries Inc. City of Industry, California	12014	Chicago Rivet & Machine Co. Bellwood, Illinois
01121	Allen-Bradley Co. Milwaukee Wisconsin	04221	Aemco Div. of Midtex Inc. Mankato, Minnesota Replaced by 75376	06980	Eitel-McCullough, Inc. San Carlos, California	12040	National Semiconductor Corp. Danbury, Connecticut
01281	TRW Semi conductors Lawndale, California	04645	Replaced by 75376	07115	Replaced by 14674	12060	Diodes, Inc. Chatsworth, California
01295	Texas Instruments, Inc. Semiconductor Components Div. Dallas, Texas	04713	Motorola Semiconductor Products Inc Phoenix, Arizona	07138	Westinghouse Electric Corp Electronic Tube Div Elmira, New York	12316	Philadelphia Handle Co. Camden, New Jersey Div. of Fairchild Camera
01686	RCL Electronic Inc Manchester, New Hampshire	05082	Replaced by 94154	072633	Fairchild Semiconductor & Instrument Corp. Mountain View, California,	12323	Presin Co., Inc. Shelton, Connecticut
01730	Deleted	05236	Jonathan Mfg. Co. Fullerton, California	07344	Bircher Co., Inc. Rochester, New York	12327	Freeway Washer & Stamping Co. Cleveland, Ohio
01884	Dearborn Electronics Inc. Orlando, Florida	05277	Westinghouse Electric Corp. Semiconductor Dept. Youngwood, Pennsylvania	07792	Jerma Engineering Corp Northampton, Massachusetts	12400	Replaced by 75042
02114	Ferroxcube Corp. Saugerties, New York	05278	Replaced by 43543	07910	Continental Device Corp. Hawthorne, California	12617	Hamlin Inc. Lake Mills, Wisconsin
02606	Replaced by 15801	05397	Union Carbide Corp Electronics Div Cleveland, Ohio	08530	Reliance Mica Corp. Brooklyn, New York	12697	Clarostat Mfg. Co. Dover, New Hampshire
02660	Amphenol-Borg Elect. Corp. Broadview, Illinois	05571	Sprague Electric Co Pacific Div. Los Angeles, California	08792	CBS Electronics Semiconductor Operations-Div. of CBS Inc Lowell, Massachusetts	12749	James Electronics Chicago, Illinois
02799	Arco Capacitors, Inc. Los Angeles, California	05704	Alac, Inc Glendale, California	08806	General Electric Co. Miniature Lamp Dept Cleveland, Ohio	12856	Micrometals Sierra Madre, California
03614	Replaced by 71400	05820	Wakefield Engineering Ind. Wakefield, Massachusetts	08863	Nylomatic Corp Norrisville, Pennsylvania	12954	Dickson Electronics Corp. Scottsdale, Arizona
03651	Replaced by 44655	06001	General Electric Company Capacitor Department Irmo, South Carolina	08988	Skottie Electronics Inc. Archbald, Pennsylvania	13606	Sprague Electric Co. Transistor Div. Concord, New Hampshire
03797	Eldema Corp. Compton, California	06136	Replaced by 63743	09922	Burndy Corp. Norwalk, Connecticut	13839	Replaced by 23732
03877	Transitron Electronic Corp Wakefield, Massachusetts	06473	Amphenol Space & Missile Sys. Chatsworth, California	11237	Chicago Telephone of Calif. Inc. South Pasadena, California	14099	Semtech Corp. Newbury Park, California
03888	Pyrofilm Resistor Co., Inc. Cedar Knolls, New Jersey	06555	Beede Electrical Instrument Co, Penacook, New Hampshire			14193	California Resistor Corp. Santa Monica, California
03911	Clairex Corp. New York, New York					14298	American Components, Inc. Conshohocken, Pennsylvania
03960	Multhead Instruments, Inc. Mountainside, New Jersey						

146155	Cornell-Dubilier Electronics Newark, New Jersey	38315	Honeywell Inc. Precision Meter Div. Manchester, New Hampshire	72665	Replaced by 90303	80145	API Instruments Co. Chesterland, Ohio
146774	Corning Glass Works Corning, New York	42498	National Company Melrose, Massachusetts	72794	Dzus Fastener Co., Inc. West Islip, New York	80183	Sprague Products North Adams, Massachusetts
14752	Electro Cube Inc. San Gabriel, California	43543	Nytronics Inc. Transformer Co. Div Alpha, New Jersey	72928	Gudeman Co Chicago, Illinois	0294	Bourns Inc. Riverside, California
14869	Replaced by 96853			72982	Erie Tech. Products Inc Erie, Pennsylvania	80583	Hammarlund Co., Inc. Mars Hill, North Carolina
15636	Elec-Trol, Inc. Northridge, California	44655	Ohmite Mfg. Co Skokie, Illinois	73138	Beckman Instruments Inc. Heliport Division Fullerton, California	80640	Stevens, Arnold Inc. Boston, Massachusetts
15801	Fenwal Electronics, Inc. Framingham, Massachusetts	49671	Radio Corp. of America New York, New York	73293	Hughes Aircraft Co. Electron Dynamics Div. Newport Beach, California	81073	Grayhill Inc. La Grange, Illinois
15818	Ameico Semiconductor Div. of Teledyne Inc. Mountain View, California	49956	Raytheon Company Lexington, Maine	73445	Amperex Electronic Corp. Hicksville, New York	81312	Winchester Electronics Div. of Litton Industries Oakville, Connecticut
15849	Useco, Inc. Mt. Vernon, New York	53021	Sangamo Electric Co. Springfield, Illinois	73559	Carling Electric Inc. Hartford, Connecticut	81439	Therm-O-Disc Inc. Mansfield, Ohio
15909	Replaced by 17870	55026	Simpson Electric Company Chicago, Illinois	73586	Circle F Industries Trenton, New Jersey	81483	International Rectifier Corp El Segundo, California
16332	Replaced by 28478	56289	Sprague Electric Co. North Adams, Massachusetts	73734	Federal Screw Products, Inc. Chicago, Illinois	81590	Korry Mfg. Co. Seattle, Washington
16473	Cambridge Scientific Ind. Inc. Cambridge, Maryland	58474	Superior Electric Co. Bristol, Connecticut	73743	Fischer Special Mfg. Co. Cincinnati, Ohio	82376	Deleted
16742	Paramount Plastics Downey, California	60399	Torrington Mfg. Co. Torrington, Connecticut	73899	JFD Electronics Co. Brooklyn, New York	82389	Switchcraft Inc. Chicago, Illinois
16758	Delco Radio Div of General Motors Kokomo, Indiana	62460	Deleted	73949	Guardian Electric Mfg. Co. Chicago, Illinois	82415	Price Electric Corp. Frederick, Maryland
17069	Circuit Structures Lab. Upland, California	63743	Ward Leonard Electric Co. Mount Vernon, New York	74199	Quam Nichols Co. Chicago, Illinois	82872	Roanwell Corp. New York, New York
17856	Siliconix, Inc. Sunnyvale, California	64834	West Mfg. Co San Francisco, California	74217	Radio Switch Corp. Marlboro, New Jersey	82877	Rotron Mfg. Co., Inc. Woodstock, New York
17870	Daven-Div. Of Thomas Edison Ind.—McGraw-Edison Co. Manchester, New Hampshire	65092	Weston Instruments, Inc. Newark, New Jersey	74276	Signalite Inc. Neptune, New Jersey	82879	ITT Wire & Cable Div. Pawtucket, Rhode Island
18083	Deleted	66150	Winslow Tele-Tronics Inc. Asbury Park, New Jersey	74306	Piezo Crystal Co. Carlisle, Pennsylvania	83003	Varo Inc. Garland, Texas
18178	Vactec, Inc. Maryland heights, Missouri	70563	Amperite Company Union City, New Jersey	74542	Hoyt Elect. Instr. Works Penacook, New Hampshire	83298	Bendix Corp. Electric Power Division Eatontown, New Jersey
18736	Voltronics Corps. Hanover, New Jersey	70903	Belden Mfg. Co. Chicago, Illinois	74970	Johnson, E.F., Co. Waseca, Minnesota	83330	Smith, Herman H., Inc. Brooklyn, New York
19429	Montronics, Inc. Seattle, Washington	71002	Birnbach Radio Co., Inc. New York, New York	75042	IRC Inc. Philadelphia, Pennsylvania	83478	Rubbercraft Corp. of America New Haven, Connecticut
19451	Perine Machinery & Supply Co. Seattle, Washington	71400	Bussmann Mfg. Div. of McGraw-Edison Co. St. Louis, Missouri	75376	Kurz-Kasch, Inc. Dayton, Ohio	83594	Burroughs Corp. Electronic components Div. Plainfield, New Jersey
19701	Electra Mfg. Co Independence, Kansas	71450	CTS Corp. Elkhart, Indiana	75382	Kulka Electric Corp. Mt. Vernon, New York	83740	Union Carbide Corp. Consumer Products Div. New York, New York
20584	Enochs Mfg. Co. Indianapolis, Indiana	71468	ITT Cannon Electric Inc. Los Angeles, California	75915	Littlefuse Inc. Des Plaines, Illinois	84171	Arco Electronics, Inc. Great Neck, New York
22767	ITT Semiconductors Div of ITT Palo Alto, California	71482	Clare, C P & Co. Chicago, Illinois	76854	Oak Mfg. Co, Crystal Lake, Illinois	84411	TRW Ogallala, Nebraska
23732	Tracor Rockville, Maryland	71590	Centralab Div of Globe Union Inc. Milwaukee, Wisconsin	77342	Potter & Brumfield Div of Amer. Machine & Foundry Princeton, Indiana	86577	Precision Metal Products Stoneham, Massachusetts
24248	Southco Div. of South Chester Corp. Lester, Pennsylvania	71707	Coto Coil Co., Inc. Providence, Rhode Island	77969	Rubbercraft Corp of Calif. LTD. Torrance, California	86684	Radio Corp. of America Electronic Components & Devices Harrison, New Jersey
24655	General Radio Co. West Concord, Massachusetts	71744	Chicago Miniature Lamp Works Chicago, Illinois	78189	Shakeproof Div. of Illinois Tool Works Elgin, Illinois	86689	Deleted
25403	Amperex Electronic Corp Semiconductor & Receiving Tube Division Slatersville, Rhode Island	71785	Cinch Mfg. Co. & Howard B Jones Div. Chicago, Illinois	78277	Sigma Instruments, Inc. South Braintree, Massachusetts	87034	Marco-Oak, Inc. Anaheim, California
28478	Detroit Controls Corp. Milwaukee, Wisconsin	72005	Driver, Wilber B., Co. Newark, New Jersey	78488	Stackpole Carbon Co. St. Marys, Pennsylvania	88419	Use 14655
28520	Heyman Mfg. Co. Kenilworth, New Jersey	72092	Replaced by 06980	78553	Tinnerman Products Cleveland, Ohio	88690	Replaced by 04217
30323	Illinois Tool Works Inc. Chicago, Illinois	72136	Electro Motive Mfg. Co. Willimantic, Connecticut	79136	Waldes Kohinoor Inc. Long Island City, New York	89536	Fluke, John Mfg. Co., Inc. Seattle, Washington
33173	General Electric Co. Tube Dept. Owensboro, Kentucky	72259	Nytronics Inc. Berkeley Heights, New Jersey	79497	Western Rubber Company Goshen, Indiana	89730	Replaced by 08806
37942	Mallory, P.R., & Co. Inc. Indianapolis, Indiana	72354	Deleted	79963	Zierick Mfg. Corp. New Rochelle, New York	90201	Mallory Capacitor Co. Indianapolis, Indiana
		72619	Dialight Corp Brooklyn, New York	80031	Mepco Div. of Sessions Clock Co. Morristown, New Jersey	90215	Best Stamp & Mfg. Co. Kansas City, Missouri
		72653	G.C. Electronics Rockford, Illinois				

90211	Square D Co. Chicago, Illinois	91934	Miller Electric Co., Inc. Pawtucket, Rhode Island	95354	Methode Mfg. Corp. Rolling Meadows, Illinois	97966	Replaced by 11358
90303	Mallory Battery Co. Tarrytown, New York	93332	Sylvania Electric Products Semiconductor Products Div Woburn, Massachusetts	95712	Dage Electric Co., Inc. Franklin, Indiana	98094	Replaced by 49956
91293	Johanson Mfg. Co. Boonton, New Jersey	94145	Replaced by 49956	95987	Weckesser Co., Inc. Chicago, Illinois	98278	Microdot Inc. Pasadena, California
91407	Replaced by 58474	94154	Tung-Sol Div. of Wagner Electric Corp Newark, New Jersey	96733	San Fernando Electric Mfg. Co San Fernando, California	98291	Seaelectro Corp. Conhex Div Mamaroneck, New York
91637	Dale Electronics Inc. Columbus, Nebraska	95146	Alco Electronics Products Inc. Lawrence, Massachusetts	96853	Rustrak Instrument Co. Manchester, New Hampshire	98388	Accurate Rubber & Plastics Culver City, California
91662	Elco Corp. Willow Grove, Pennsylvania	95263	Leecraft Mfg. Co. Long Island City, New York	96881	Thomson Industries, Inc. Manhasset, New York	98743	Replaced by 12749
91737	Gremar Mfg. Co., Inc. Wakefield, Massachusetts	95264	Replaced by 98278	97540	Master Mobile Mounts Div. of Whitehall Electronics Corp. Los Angeles, California	98925	Deleted
91802	Industrial Devices, Inc. Edgewater, New Jersey	95275	Vitramon Inc. Bridgeport, Connecticut	97945	White, S. S. Co. Plastics Div. New York, New York	99120	Plastic Capacitors, Inc. Chicago, Illinois
91836	King's Electronics Tuckahoe, New York	95303	Radio Corp. of America Solid State & Receiving Tube Cincinnati, Ohio			99217	Southern Electronics Corp. Burbank, California
91929	Honeywell Inc. Micro Switch Div. Freeport, Illinois					99515	Marshall Industries Capacitor Div. Monrovia, California

**Revised August 1, 1968  
Using H4-1 and H4-2  
Dated June, 1968**

List of Abbreviations

A, amp	ampere	m	milli or 10 <sup>-3</sup>
amply	amplifier	mm	millimeter
ac	alternating current	n	nano or 10 <sup>-9</sup>
assy	assembly	neg	negative
BCD	binary coded decimal	Ω	ohm
cap	capacitor	osc	oscilloscope
car	carbon	ppm	parts per million
cm	centimeter	piv	peek inverse voltage
C	centigrade	p-p	peak to peak
cer	ceramic	p	pico or 10 <sup>-12</sup>
cw	clockwise	plstc	plastic
CMRR	common mode rejection ratio	±	plus or minus
comp	composition	pos	positive
CCW	counterclockwise	pps	pulses per second
conn	connector	PCB	printed circuit board
CRT	cathode ray tube	QTY	quantity
cps	cycles per second	rf	radio frequency
db	decibel	rfi	radio frequency interference
dvm	digital voltmeter	REC	recommended
dc	direct current	REF	reference
dpdt	double-pole, double-throw	RH	relative humidity
dpst	double-pole, single-throw	res	resistor
elec	electrolytic	rms	root mean square
ext	external	rtry	rotary
f	fahrenheit	sec	second
F	farad	sect	section
FET	field effect transistor	S/N	serial number
fim	film	Si	silicon
Ge	germanium	scr	silicon controlled rectifier
g	giga or 10 <sup>9</sup>	spdt	single-pole, double-throw
gnd	ground	spst	single-pole, single-throw
gmV	guaranteed minimum value	sw	switch
grd	guard	Ta	tantalum
h	henry	TC	temperature coefficient
Hz	hertz	t	tera or 10 <sup>12</sup>
hf	high frequency	xfmr	transformer
IC	integrated circuit	tstr	transistor
if	intermediate frequency	tvm	transistor voltmeter
int	internal	uhf	ultra high frequency
kc	kilocycle	vtvm	vacuum tube voltmeter
k	kilo (10 <sup>3</sup> )	var	variable
if	low frequency	vhf	very high frequency
mc	megacycle	vlf	very low frequency
M	meg or mega (10 <sup>6</sup> )	V	volt
met	metal	VCO	voltage controlled oscillator
MOS	metal oxide silicon	w	watt
μ	micro or 10 <sup>-6</sup>	ww	wire wound



**APPENDIX C  
MAINTENANCE ALLOCATION**

---

**Section I. INTRODUCTION**

**C-1. General**

This appendix provides a summary of the maintenance operations covered in the equipment literature for the JF 332B/AF. It authorizes categories of maintenance for specific maintenance functions on repairable items and components and the tools and equipment required to perform each function. This appendix may be used as an aid in planning maintenance operations.

**C-2. Maintenance Functions**

Maintenance functions will be limited to and defined as follows:

a. *INSPECT*. To determine serviceability of an item by comparing its physical, mechanical, and electrical characteristics with established standards.

b. *TEST*. To verify serviceability and to detect incipient electrical or mechanical failure by use of special equipment such as gages, meters, etc. This is accomplished with external test equipment and does not include operation of the equipment and operator type tests using internal meters or indicating devices.

c. *SERVICE*. To clean, to preserve, to charge, and to add fuel, lubricants, cooling agents, and air. If it is desired that elements, such as painting and lubricating, be defined separately, they may be so listed.

d. *ADJUST*. To rectify to the extent necessary to bring into proper operating range.

e. *ALIGN*. To adjust two or more components or assemblies of an electrical or mechanical system -so that their functions are properly synchronized. This does not include setting the frequency control knob of radio receivers or transmitters to the desired frequency.

f. *CALIBRATE*. To determine the corrections to be made in the readings of instruments or test equipment used in precise measurement. Consists of the comparison of two instruments, one of which is a certified standard of known accuracy, to detect and adjust any discrepancy in the accuracy of the instrument being compared with the certified standard.

g. *INSTALL*. To set up for use in an operational environment such as an encampment, site, or vehicle.

h. *REPLACE*. To replace unserviceable items with serviceable like items.

i. *REPAIR*. To restore an item to serviceable condition through correction of a specific failure or unserviceable condition. This function includes, but is not limited to welding, grinding, riveting, straightening, and replacement of parts other than the trial and error replacement of running spare type items such as fuses, lamps, or electron tubes.

i. *OVERHAUL*. Normally, the highest degree of maintenance performed by the Army in order to minimize time work in process is consistent with quality and economy of operation. It consists of that maintenance necessary to restore an item to completely serviceable condition as prescribed by maintenance standards in technical publications for each item of equipment. Overhaul normally does not return an item to like new, zero mileage, or zero hour condition.

k. *REBUILD*. The highest degree of materiel maintenance. It consists of restoring equipment as nearly as possible to new condition in accordance with original manufacturing standards. Rebuild is performed only when required by operational considerations or other paramount factors and then only at the depot maintenance category. Rebuild reduces to zero the hours or miles the equipment, or component thereof, has been in use.

l. *SYMBOLS*. The uppercase letter placed in the appropriate column indicates the lowest level at which that particular maintenance function is to be performed.

**C-3. Explanations of Format**

a. *Column 1, Group Number*. Identifies components, assemblies, sub-assemblies, and modules with the next higher assembly.

b. *Column 2, Functional Group*. Column 2 lists the noun names of components, assemblies, subassemblies, and modules on which maintenance is authorized.

c. *Column 3, Maintenance Functions*. Column 3 lists the maintenance category at which performance of the specific maintenance function is authorized. Authorization to perform a function at any category also includes authorization to perform that function at higher categories: The codes used represent the various maintenance categories as follows:

<i>Code</i>	<i>Manufacturer's name</i>
C.....	Operator/crew
O.....	Organizational maintenance
F.....	Directs support maintenance
H.....	General support maintenance
D.....	Depot maintenance

d. *Column 4, Tools and Equipment*. Column 4 specifies, by code, those tools and test equipment

required to perform the designation function. The numbers appearing in this column refer to specific tools and test equipment which are identified in section III.

*e. Column 5, Remarks. Self-explanatory.*

#### **C-4. Explanation of Format of Section III, Tool and Test Equipment Requirements**

The columns in Section III, Tool and Test Equipment Requirements, are as follows:

*a. Tools and Equipment.* The numbers in this column coincide with the numbers used in the tools and equipment column of the Maintenance Allocation Chart. The numbers indicate the applicable tool for the maintenance function.

*b. Maintenance Category.* The codes in this column indicate the maintenance category normally allocated the facility.

*c. Nomenclature.* This column lists tools, test, and maintenance equipment required to perform the maintenance functions.

*d. Federal Stock Number.* This column lists the Federal stock number of the specific tool or test equipment.

#### **Note**

**The subassemblies listed in Section H, requiring Depot Repair, are the plug-in boards that have been put into the "exchange board program." Repair of these boards are to be repaired by the depot/s responsible for this function.**

**SECTION II  
MAINTENANCE ALLOCATION CHART**

**FOR DC VOLTAGE STANDARD, JF -332B/AF  
CHART NLMBER 332B/AF  
MAC PAGE**

(1) GROUP NUMBER	(2) FUNCTIONAL GROUP	(3) MAINTENANCE FUNCTIONS											(4)	(5)
		a INSPECT	b TEST	c SERVICE	d ADJUST	e ALIGN	f CALIBRATE	g INSTALL	h REPLACE	i REPAIR	j OVERHAUL	k REBUILD	l TOOL REQD	m REMARKS
	01 STANDARD DC VOLTAGE	H	H	H			H	F	H	H	D	D	1-13	
0101	CAPACITOR P/C ASSEMBLY	H							H	H				
0102	SAMPLE STRING P/C ASSEMBLY	H							H	H				
0103	CAPACITOR SWITCH P/C ASSEMBLY	H							H	H				
0104	RANGE CALIBRATOR P/C ASSEMBLY	H							H	H				
0105	MAIN MOTHER BOARD	H							H	H				
0106	TIME DELAY P/C ASSEMBLY	H							H	H				
0107	HIGH VOLTAGE MOTHER BOARD P/C ASSEMBLY	H							H	H				
0108	DIFFERENTIAL AMPLIFIER P/C ASSEMBLY	H							H	D			13	
0109	CHOPPER AMPLIFIER ASSEMBLY	H							H	D			13	
0110	AUXILIARY POWER SUPPLY P/C ASSEMBLY	H							H	D			13	
0111	CURRENT LIMITER P/C ASSEMBLY	H							H	D			13	
0112	SERIES PASSELEMENT P/C ASSEMBLY	H							H	D			13	
0113	PREREGULATOR P/C ASSEMBLY	H							H	D			13	
0114	REFERENCE SUPPLY P/C ASSEMBLY	H							H	D			13	
0115	SERIES PASS DRIVER P/C ASSEMBLY	H							H	D			13	

**SECTION III TOOL AND TEST EQUIPMENT REQUIREMENTS**

<b>TOOLS AND TEST EQUIPMENT REQUIREMENTS</b>				
<b>TOOLS AND EQUIPMENT</b>	<b>MAINTENANCE CATEGORY</b>	<b>NOMENCLATURE</b>	<b>FEDERAL STOCK NUMBER</b>	<b>TOOL NUMBER</b>
1	H	TRANSFORMER, VARIABLE, POWER, MODEL W10MT3AS3	6120-168-3705	
2	H	VOLTAGE DIVIDER, ESI RV 726	4931-130-5383	
3	H	RESISTOR DECADE B-G 601147-1	4931-071-5343	
4	H	GENERATOR, DETECTOR ESI 801	4931-913-2994	
5	H	VOLTAGE STANDARD DC JF-332A	4931-913-3062	
6	H	CELL, STANDARD EPPLEY 106-4	4931-682-0993	
7	H	REGULATOR, LINE MODEL 4102	6625-628-1754	
8	H	CABLE ASSEMBLY, RF 30 IN. RG-58/U	4931-846-0010	
9	H	LEAD, ELECTRICAL, 24 IN., 18 AWG	4931-739-4433	
10	H	KEY, GALVANOMETER, REVERSING SWITCH	4931-130-5388	
11	H	CABLE, POWER, ELECTRICAL (FOUR 36 IN. LENGTHS REQUIRED)	6145-132-4800	
12	H	TOOL KIT CALIBRATION TECHNICIAN	4935-670-7123	
13	D	TOOLS AND TEST EQUIPMENT AVAILABLE TO THE REPAIRMAN BECAUSE OF HIS ASSIGNED MISSION		

**APPENDIX D  
BASIC ISSUE ITEMS LIST**

**Section I. INTRODUCTION**

**D-1. Scope**

This appendix lists items which accompany the JF 332B/Af, and are required for installation, operation, or operator's maintenance.

**D-2. General**

This Basic Issue Items List is divided into the following sections:

*a. Basic Issue Items-Section II.* A list of items which accompany the JF 332B/AF and are required by the operator/crew for installation, operation, or maintenance.

*b. Maintenance and Operating Supplies-Section II.* Not applicable.

**D-3. Explanation of Columns**

The following provides an explanation of columns in the tabular list of Basic Issue Items, Section II.

*a. Source, Maintenance, and Recoverability Codes (SMR), Column 1.*

(1) Source code indicates the selection status and source for the listed item. Source codes are-

<i>Code</i>	<i>Explanation</i>
P-	Repair parts which are stocked in or supplied from the GSA/DSA, or Army supply system, and authorized for use at indicated maintenance categories.
P2-	Repair parts which are procured and stocked for insurance purposes because the combat or military essentiality of the end item dictates that a minimum quantity be available in the supply system.
P9-	Assigned to items which are NSA design controlled: unique repair parts, special tools, test, measuring and diagnostic equipment, which are stocked and supplied by the Army COMSEC logistic system. and which are not subject to the provisions of AR 38041.
P10-	Assigned to items which are NSA designed controlled: special tools, test, measuring and diagnostic equipment for COMSEC support, which are accountable under the provisions of AR 380-41, and which are stocked and supplied by the Army COMSEC logistic system.
M-	Repair parts which are not procured or stocked, but are to be manufactured in indicated maintenance levels.
A-	Assemblies which are not procured or stocked as such, but are made up of two or more units. Such component units carry individual stock numbers and descriptions. are procured and stocked separately, and can be assembled to form the required assembly at indicated maintenance categories.
X-	Parts and assemblies which are not procured or stocked and the mortality of which normally is below that of the applicable end item or component. The

failure of such part or assembly should result in retirement of the end item from the supply system.

<i>Code</i>	<i>Explanation</i>
X1-	Repair parts which are not procured or stocked. The requirement for such items will be filled by use of the next higher assembly or component.
X2-	Repair parts which are not stocked. The indicated maintenance category requiring such repair parts will attempt to obtain same through cannibalization, requirements will be requisitioned with accompanying justification through normal supply channels.
C-	Repair parts authorized for local procurement. Where such repair parts are not obtainable from local procurement, requirements will be requisitioned through normal supply channels accompanied by a supporting statement of nonavailability from local procurement.
G-	Major assemblies that are procured with EMA funds for initial issue only as exchange assemblies at DSU and GSU level. These assemblies will not be stocked above DS and GS level or returned to depot supply level.

(2) Maintenance code indicates the lowest category of maintenance authorized to install the listed item. The maintenance level codes are-

<i>Code</i>	<i>Explanation</i>
C.....	Operator/crew
O.....	Organizational maintenance

(3) Recoverability code indicates whether unserviceable items should be returned for recovery or salvage. Items not coded are expendable. Recoverability codes are-

<i>Code</i>	<i>Explanation</i>
R-	Repair parts and assemblies that are economically repairable at DSU and GSU' activities and are normally furnished by supply on an exchange basis.
S-	Repair parts and assemblies which are economically repairable at DSU and GSU activities and which normally are furnished by supply on an exchange basis. When items are determined by a GSL to be uneconomically repairable, they will be evacuated to a depot for evaluation and analysis before final disposition.
T-	High dollar value recoverable repair parts which are subject to special handling and are issued on an exchange basis. Such repair parts normally are repaired or overhauled at depot maintenance activities.
U-	Repair parts specifically selected for salvage by reclamation units because of precious metal content, critical materials, or high dollar value reusable casings or castings.

*b. Federal Stock Number, Column 2.* This column indicates the Federal stock number assigned to the item and will be used for requisitioning purposes.

*c. Description, Column 3.* This column indicates the Federal item name and any additional description of the item required. A part number of other

reference number is followed by the applicable five-digit Federal supply code for manufacturers in parentheses.

d. *Unit of Measure (U/M), Column 4.* A 2-character alphabetic abbreviation indicating the amount or quantity of the item upon which the allowances are based; e.g., ft, ea, pr, etc.

e. *Quantity Incorporated in Unit, Column 5.* This column indicates the quantity of the item used in the JF

332B/AF. A "V" appearing in this column in lieu of a quantity indicates that a definite quantity cannot be indicated (e.g., shims, spacers, etc.).

f. *Quantity Furnished With Equipment, Column 6.* This column indicates the quantity of an item furnished with the equipment.

g. *Illustration, Column 7.* Not applicable.

**SECTION II  
BASIC ISSUE ITEMS**

(1)  SMR Code	(2)  Federal Stock Number	(3) Description  Ref no. & mfr Code  Usable on code		(4) Unit of Meas	(5) Qty inc in Unit	(6) Qty furn with equip	(7) Illustration	
							(A) Fig no.	(B) Item No.
		Board, Extender; FSC 89536 MFG Part No. 1702-187344.		Ea.	1	1		

By Order of the Secretary of the Army:

Official:

VERNE L. BOWERS,  
*Major General, United States Army,  
The Adjutant General.*

W. C. WESTMORELAND,  
*General, United States Army,  
Chief of Staff.*

Distribution:

To be distributed in accordance with DA Form 12-34, Section II (qty rqr block no. 76) requirements for Calibration Publications Procedures.

☆ U S GOVERNMENT PRINTING OFFICE 1984--746-036/3072 Region #4

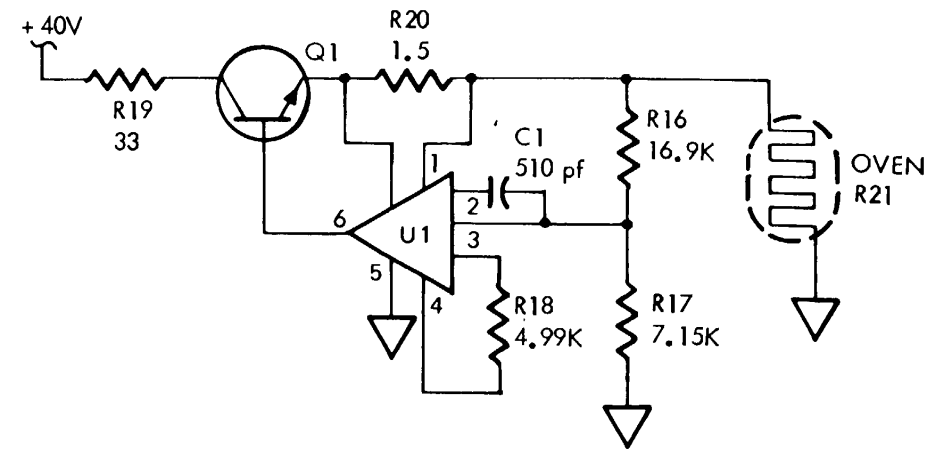
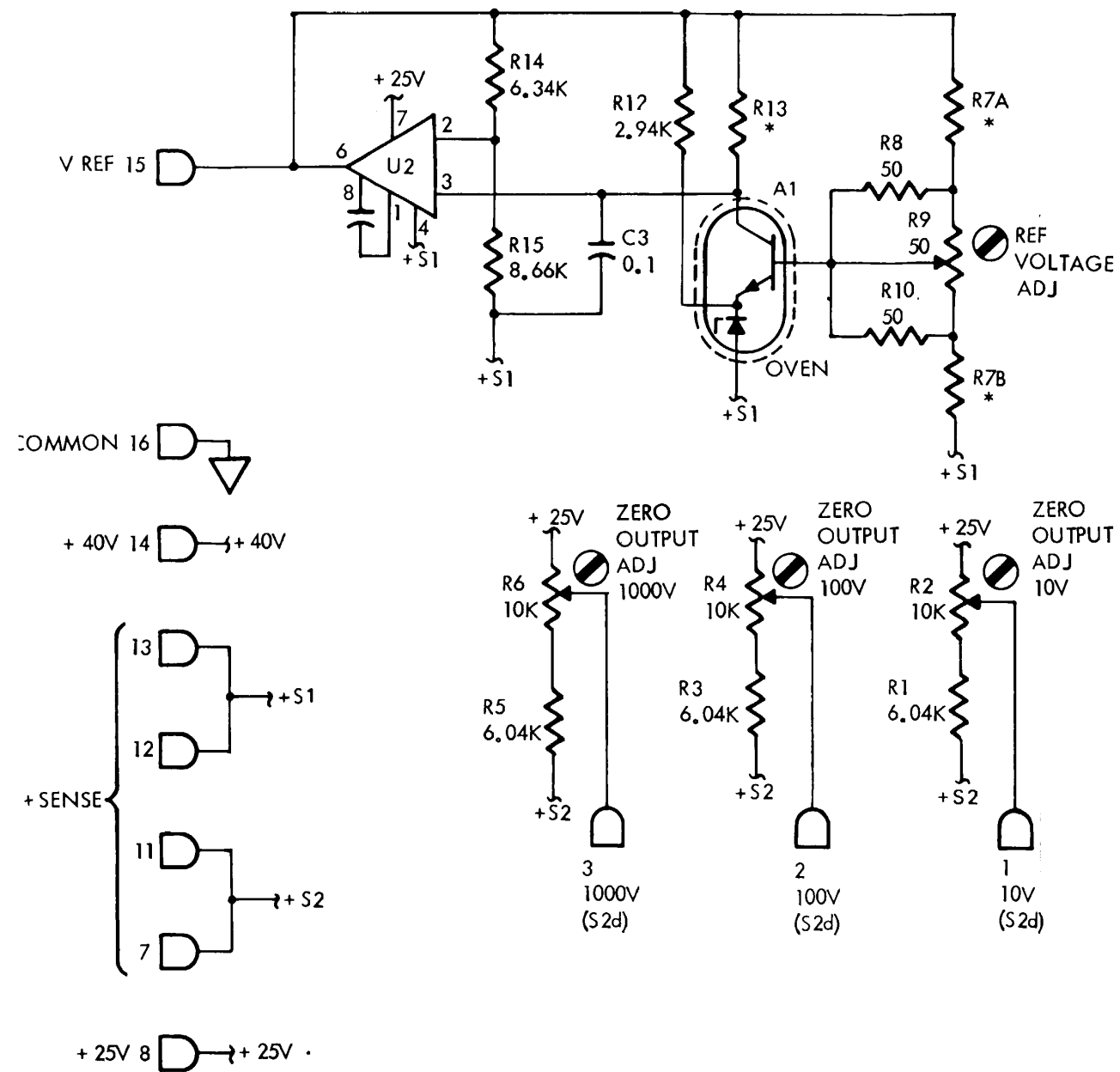

NOTES:

- (1) ALL RESISTANCES IN OHMS AND ALL CAPACITANCES IN MICROFARADS UNLESS OTHERWISE SPECIFIED.
- (2) ⊗ INDICATES INTERNAL ADJUSTMENT.
- (3) 1, 2, 3 INDICATE DIFFERENT COMMON POINTS.
- (4) \* INDICATES FACTORY SELECTED VALUE.

FUNCTIONAL SCHEMATIC DIAGRAM	
A5A1	1
REFERENCE SUPPLY	
332B/AF-1083	REV -
JOHN FLUKE MFG. CO., INC. P. O. Box 7428 Seattle, Washington 98133	



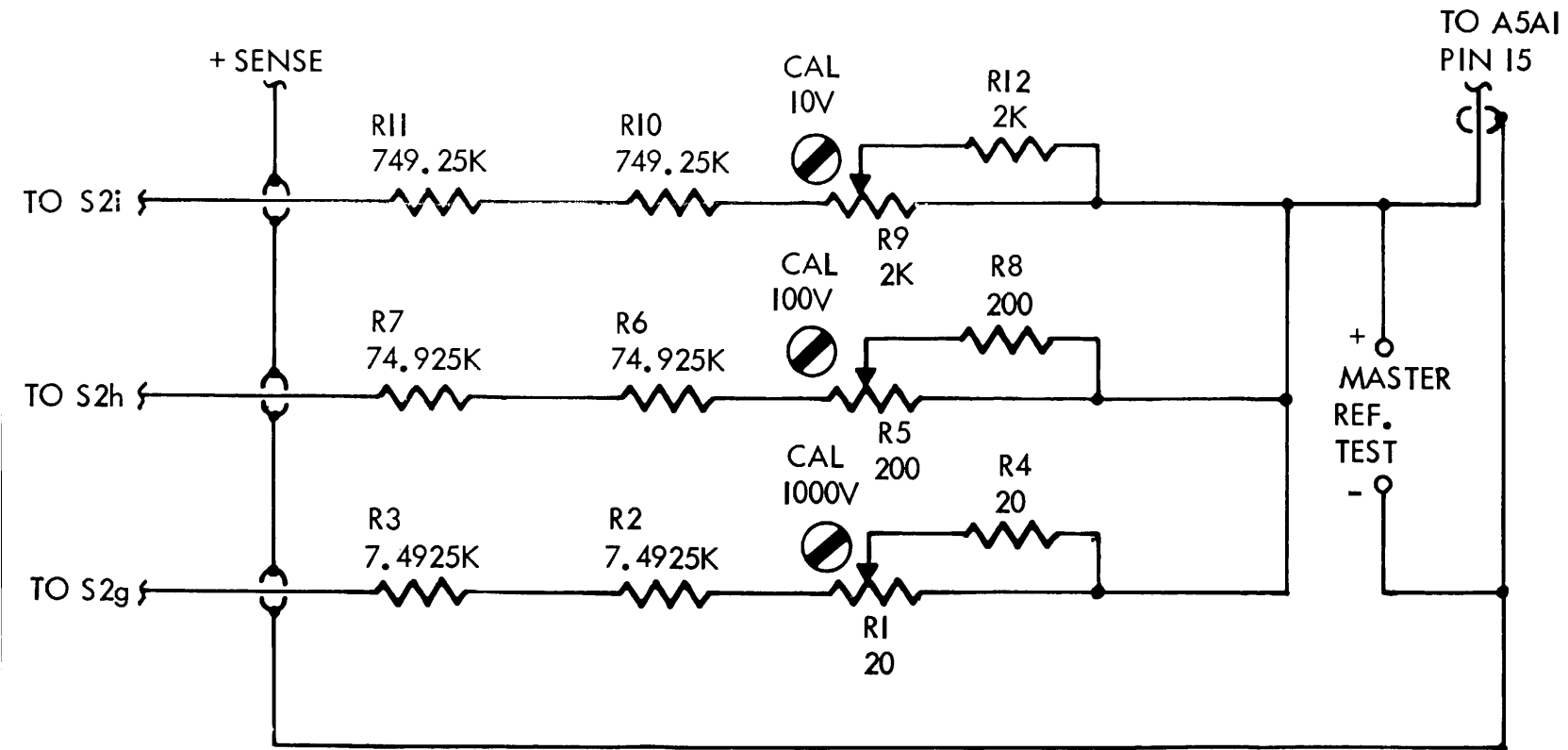

NOTES:

(1) ALL RESISTANCES IN OHMS AND ALL CAPACITANCES IN MICROFARADS UNLESS OTHERWISE SPECIFIED.

(2)  INDICATES INTERNAL ADJUSTMENT.

(3) , ,  INDICATES DIFFERENT COMMON POINTS.

(4) \* INDICATES FACTORY SELECTED VALUE.

FUNCTIONAL SCHEMATIC DIAGRAM	
A4	2
RANGE CAL.	
3328/AF - 1052	RIV
-	
 JOHN FLUKE MFG. CO., INC. P. O. Box 7428 Seattle, Wash. 98113	

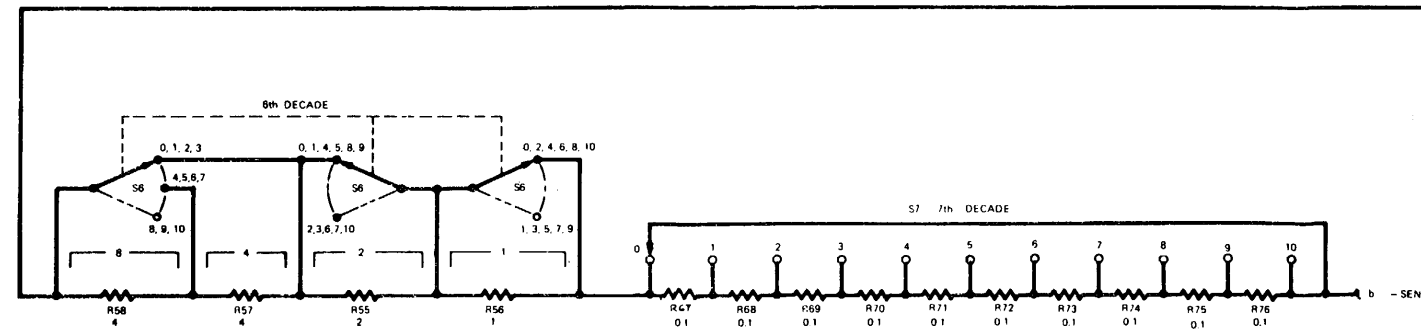
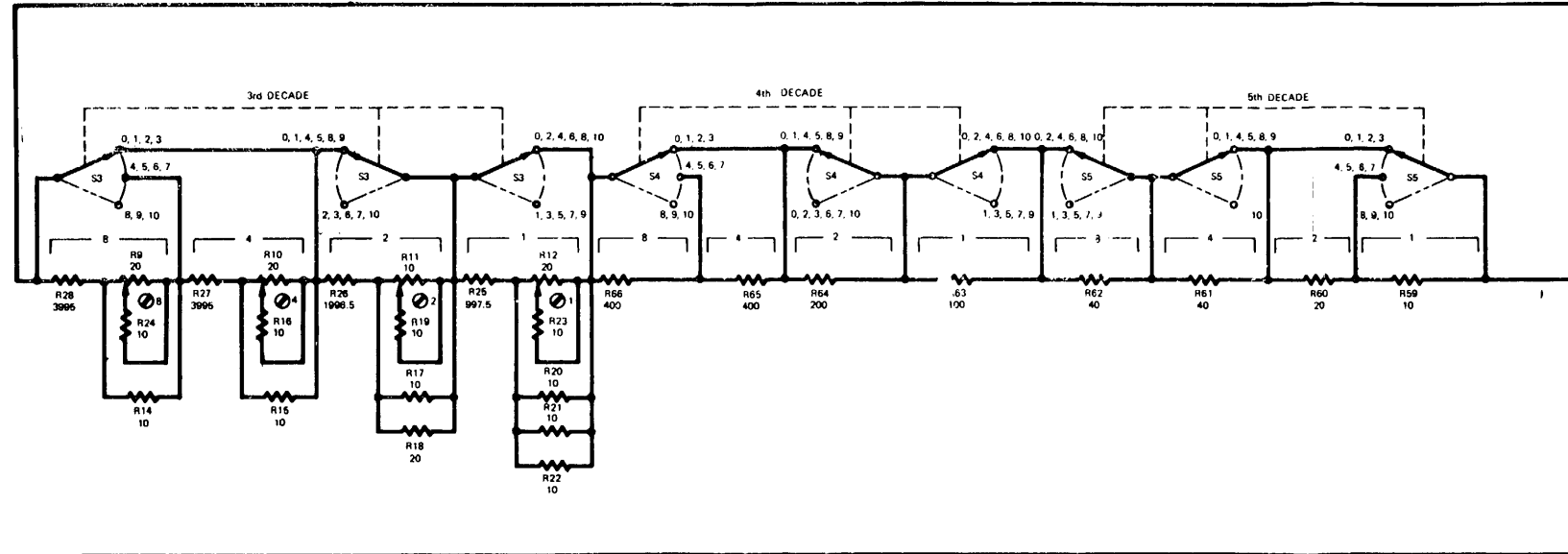
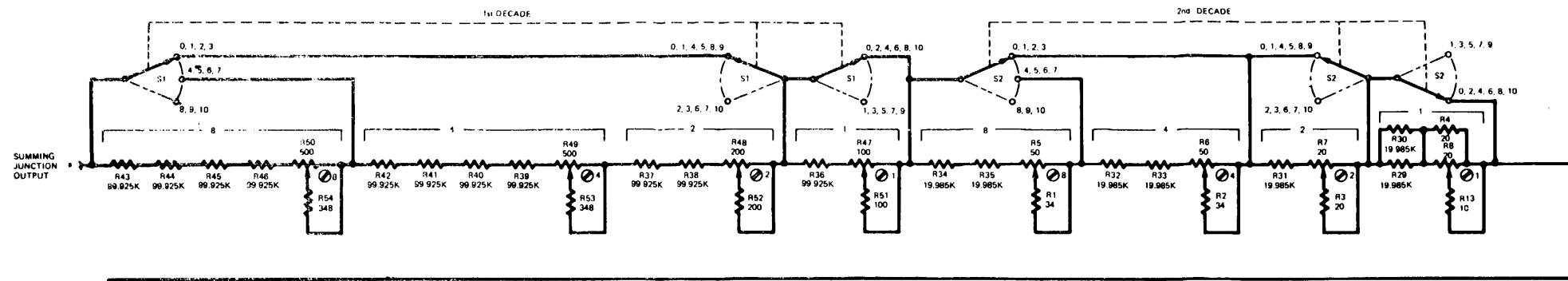

- NOTES:
- (1) ALL RESISTANCES IN OHMS AND ALL CAPACITANCES IN MICROFARADS UNLESS OTHERWISE SPECIFIED.
  - (2) ⊗ INDICATES INTERNAL ADJUSTMENT.
  - (3) INDICATES DIFFERENT COMMON POINT.
  - (4) \* INDICATES FACTORY SELECTED VALUE.

FUNCTIONAL SCHEMATIC DIAGRAM	
A2	3
SAMPLE STRING	
332B/AF-1051	REV. 8
JOHN FLUKE MFG. CO., INC. P. O. Box 7428 Seattle, Washington 98133	

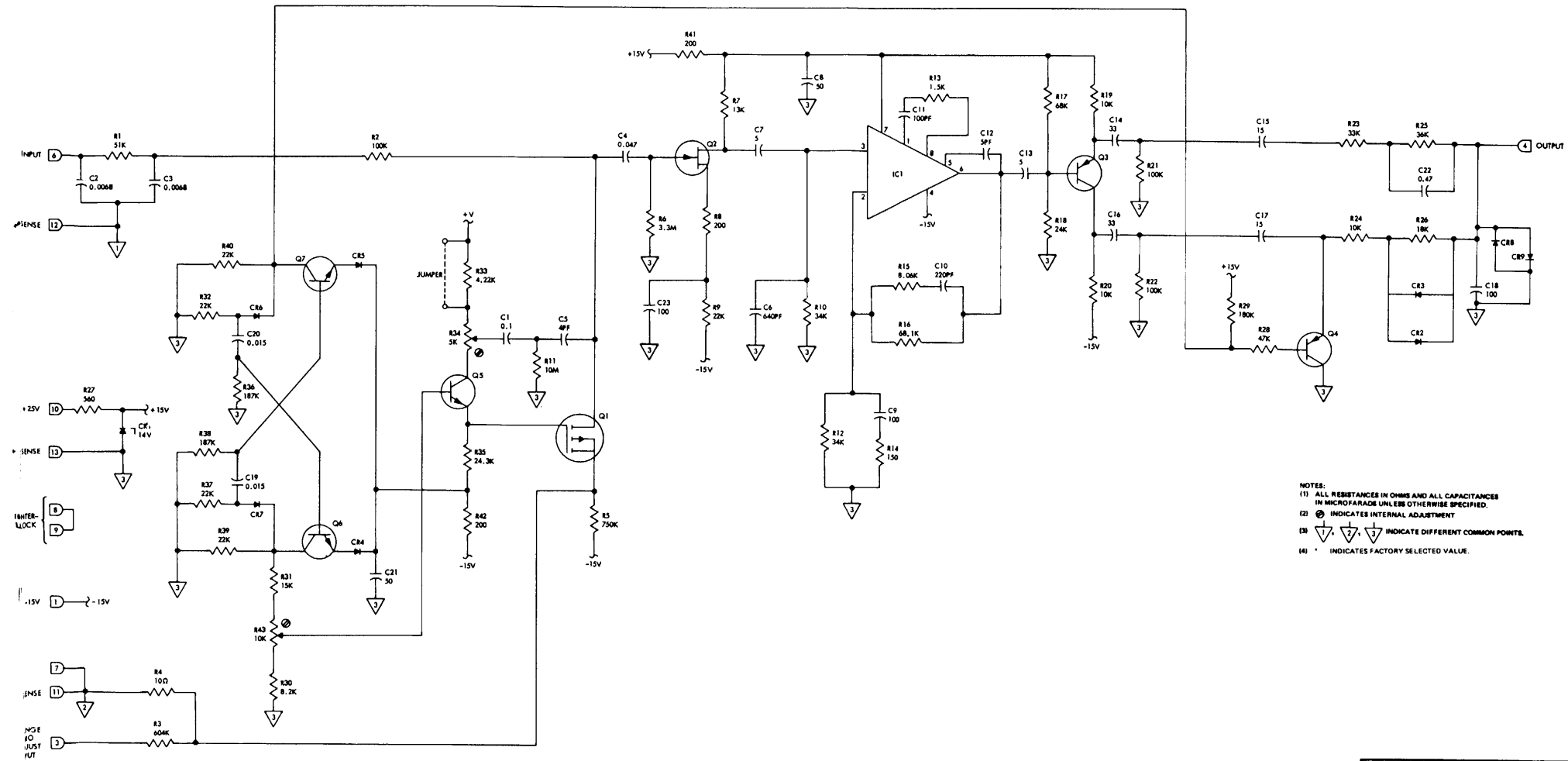

NOTES:  
 (1) ALL RESISTANCES IN OHMS AND ALL CAPACITANCES IN MICROFARADS UNLESS OTHERWISE SPECIFIED.  
 (2) ⊕ INDICATES INTERNAL ADJUSTMENT.  
 (3) ▽, ▽, ▽, ▽ INDICATE DIFFERENT COMMON POINTS.  
 (4) \* INDICATES FACTORY SELECTED VALUE.

FUNCTIONAL SCHEMATIC DIAGRAM	
A5A4	
CHOPPER AMPLIFIER	
332B/AF-1058	REV —
JOHN FLUKE MFG. CO., INC. P. O. Box 7426 Seattle, Washington 98133	

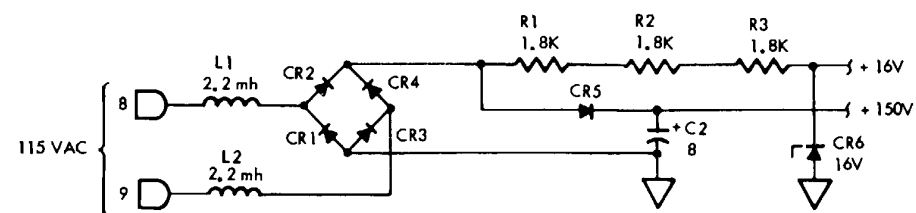
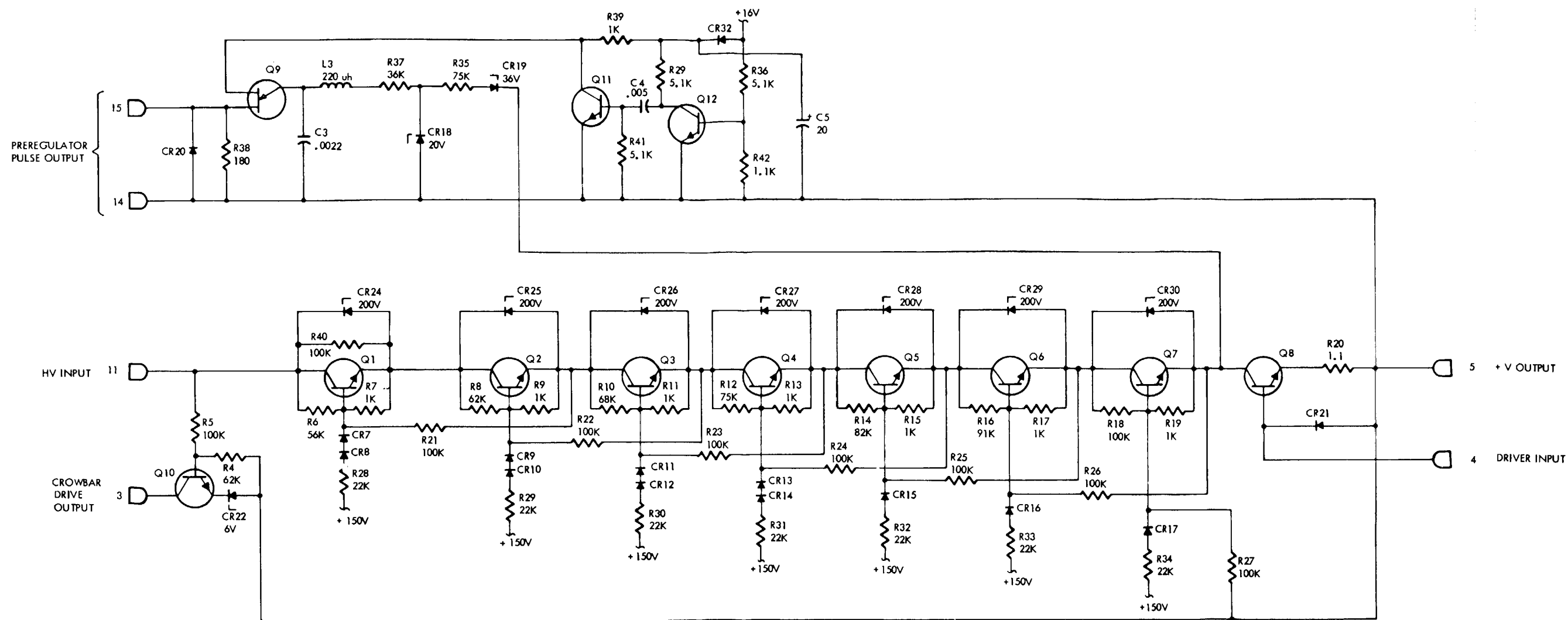

NOTES:

- (1) ALL RESISTANCES IN OHMS AND ALL CAPACITANCES IN MICROFARADS UNLESS OTHERWISE SPECIFIED.
- (2) ⊗ INDICATES INTERNAL ADJUSTMENT.
- (3) 1, 2, 3 INDICATE DIFFERENT COMMON POINTS.
- (4) \* INDICATES FACTORY SELECTED VALUE.

FUNCTIONAL SCHEMATIC DIAGRAM	
A7A1	5
SERIES PASS	
332B/AF-1061	REV. -
JOHN FLUKE MFG. CO., INC. P.O. Box 7428 Seattle, Washington 98133	

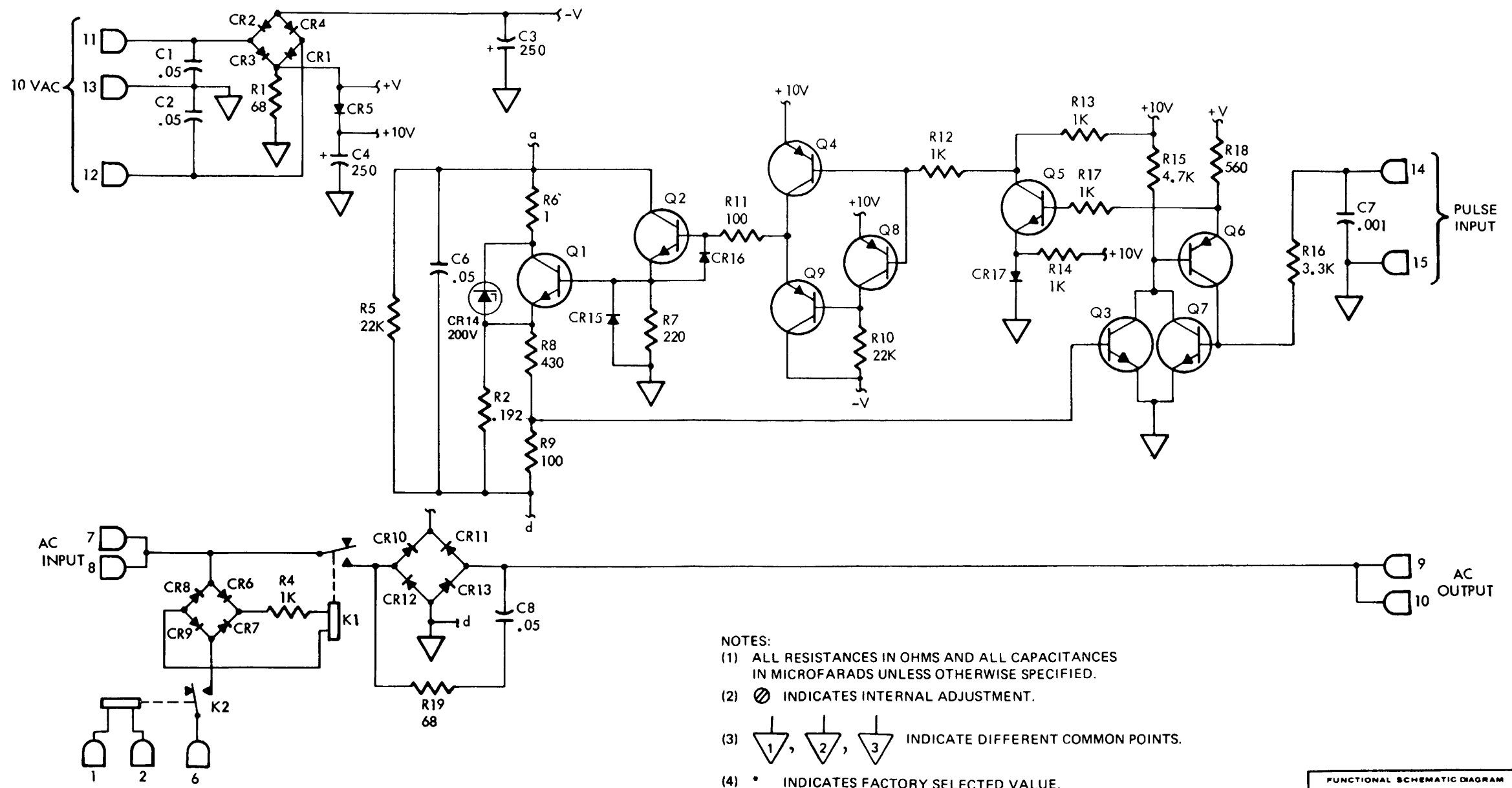

- NOTES:
- (1) ALL RESISTANCES IN OHMS AND ALL CAPACITANCES IN MICROFARADS UNLESS OTHERWISE SPECIFIED.
  - (2) ⊗ INDICATES INTERNAL ADJUSTMENT.
  - (3) 1, 2, 3 INDICATE DIFFERENT COMMON POINTS.
  - (4) \* INDICATES FACTORY SELECTED VALUE.

FUNCTIONAL SCHEMATIC DIAGRAM	
A7A2	
PREREGULATOR	
332B/AF-1082	REV a
JOHN FLUKE MFG. CO., INC. P.O. Box 7428 Seattle, Washington 98133	

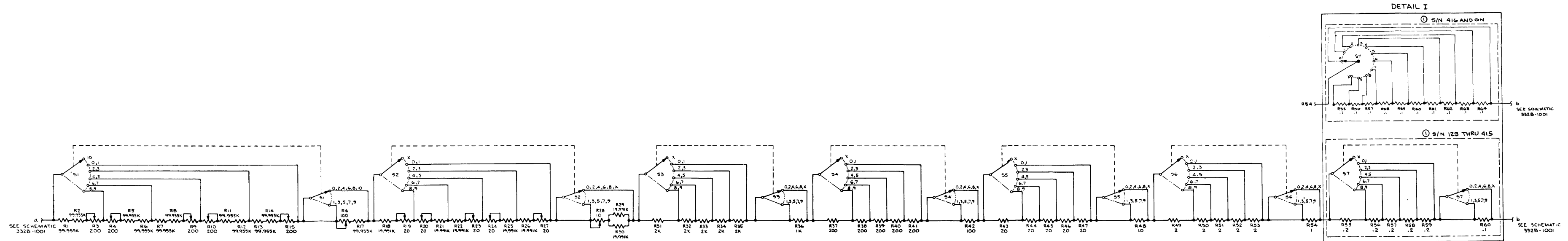

CHANGES:  
 ① FOR S/N 416 AND ON:  
 S7 CONFIGURATION CHANGED.  
 R55 THRU R60 W/CARD RESISTORS  
 CHANGED TO RES THRU R64  
 RESISTANCE WIRE.  
 ② MODIFIED ASSEMBLY ON 332B/AF  
 SEE 332B/AF - 1051

FUNCTIONAL SCHEMATIC DIAGRAM	
SAMPLE STRING	
② 332B-1003	
MODE: 332B DC VOLTAGE STANDARD	
REV. NO. 133 & ON	C
JOHN FLUKE MFG. CO., INC.	
P.O. Box 7028 Seattle, Washington 98122	

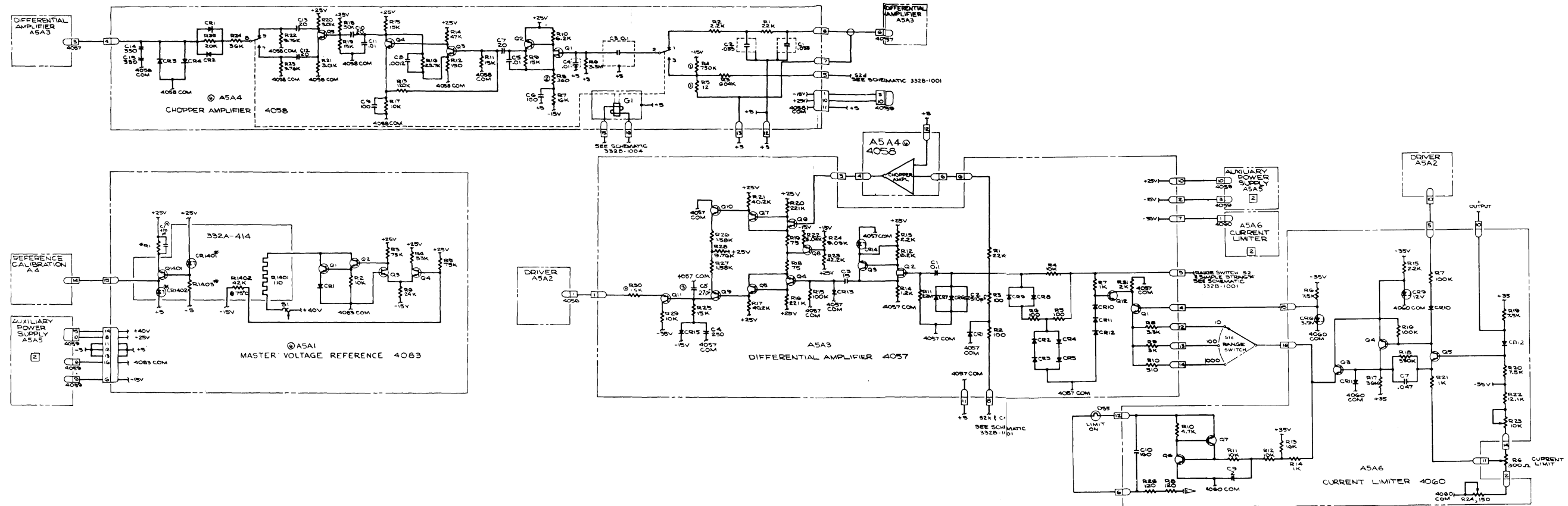

- CHANGES:
1. R4 WAS Q-24K AND R5 WAS 10K FROM 5.1K TO 10K.
  2. A5A4RB WAS CHANGED FROM 200 Ω TO 50 Ω. R7, R8, R9, R10, R11, R12, R13, R14, R15, R16 AND Q1.
  3. C5 IN PLACE OF R10 IN 4057 (4057A) TO 300 Ω. R10, R11, R12, R13, R14, R15, R16, R17, R18, R19, R20, R21, R22, R23, R24, R25, R26, R27, R28, R29, R30, R31, R32, R33, R34, R35, R36, R37, R38, R39, R40, R41, R42, R43, R44, R45, R46, R47, R48, R49, R50, R51, R52, R53, R54, R55, R56, R57, R58, R59, R60, R61, R62, R63, R64, R65, R66, R67, R68, R69, R70, R71, R72, R73, R74, R75, R76, R77, R78, R79, R80, R81, R82, R83, R84, R85, R86, R87, R88, R89, R90, R91, R92, R93, R94, R95, R96, R97, R98, R99, R100.
  4. A5A6 CURRENT LIMITER.
  5. A5A6 CURRENT LIMITER.
  6. A5A6 CURRENT LIMITER.
  7. A5A6 CURRENT LIMITER.
  8. A5A6 CURRENT LIMITER.
  9. A5A6 CURRENT LIMITER.
  10. A5A6 CURRENT LIMITER.
  11. A5A6 CURRENT LIMITER.
  12. A5A6 CURRENT LIMITER.
  13. A5A6 CURRENT LIMITER.
  14. A5A6 CURRENT LIMITER.
  15. A5A6 CURRENT LIMITER.
  16. A5A6 CURRENT LIMITER.
  17. A5A6 CURRENT LIMITER.
  18. A5A6 CURRENT LIMITER.
  19. A5A6 CURRENT LIMITER.
  20. A5A6 CURRENT LIMITER.
  21. A5A6 CURRENT LIMITER.
  22. A5A6 CURRENT LIMITER.
  23. A5A6 CURRENT LIMITER.
  24. A5A6 CURRENT LIMITER.
  25. A5A6 CURRENT LIMITER.
  26. A5A6 CURRENT LIMITER.
  27. A5A6 CURRENT LIMITER.
  28. A5A6 CURRENT LIMITER.
  29. A5A6 CURRENT LIMITER.
  30. A5A6 CURRENT LIMITER.
  31. A5A6 CURRENT LIMITER.
  32. A5A6 CURRENT LIMITER.
  33. A5A6 CURRENT LIMITER.
  34. A5A6 CURRENT LIMITER.
  35. A5A6 CURRENT LIMITER.
  36. A5A6 CURRENT LIMITER.
  37. A5A6 CURRENT LIMITER.
  38. A5A6 CURRENT LIMITER.
  39. A5A6 CURRENT LIMITER.
  40. A5A6 CURRENT LIMITER.
  41. A5A6 CURRENT LIMITER.
  42. A5A6 CURRENT LIMITER.
  43. A5A6 CURRENT LIMITER.
  44. A5A6 CURRENT LIMITER.
  45. A5A6 CURRENT LIMITER.
  46. A5A6 CURRENT LIMITER.
  47. A5A6 CURRENT LIMITER.
  48. A5A6 CURRENT LIMITER.
  49. A5A6 CURRENT LIMITER.
  50. A5A6 CURRENT LIMITER.
  51. A5A6 CURRENT LIMITER.
  52. A5A6 CURRENT LIMITER.
  53. A5A6 CURRENT LIMITER.
  54. A5A6 CURRENT LIMITER.
  55. A5A6 CURRENT LIMITER.
  56. A5A6 CURRENT LIMITER.
  57. A5A6 CURRENT LIMITER.
  58. A5A6 CURRENT LIMITER.
  59. A5A6 CURRENT LIMITER.
  60. A5A6 CURRENT LIMITER.
  61. A5A6 CURRENT LIMITER.
  62. A5A6 CURRENT LIMITER.
  63. A5A6 CURRENT LIMITER.
  64. A5A6 CURRENT LIMITER.
  65. A5A6 CURRENT LIMITER.
  66. A5A6 CURRENT LIMITER.
  67. A5A6 CURRENT LIMITER.
  68. A5A6 CURRENT LIMITER.
  69. A5A6 CURRENT LIMITER.
  70. A5A6 CURRENT LIMITER.
  71. A5A6 CURRENT LIMITER.
  72. A5A6 CURRENT LIMITER.
  73. A5A6 CURRENT LIMITER.
  74. A5A6 CURRENT LIMITER.
  75. A5A6 CURRENT LIMITER.
  76. A5A6 CURRENT LIMITER.
  77. A5A6 CURRENT LIMITER.
  78. A5A6 CURRENT LIMITER.
  79. A5A6 CURRENT LIMITER.
  80. A5A6 CURRENT LIMITER.
  81. A5A6 CURRENT LIMITER.
  82. A5A6 CURRENT LIMITER.
  83. A5A6 CURRENT LIMITER.
  84. A5A6 CURRENT LIMITER.
  85. A5A6 CURRENT LIMITER.
  86. A5A6 CURRENT LIMITER.
  87. A5A6 CURRENT LIMITER.
  88. A5A6 CURRENT LIMITER.
  89. A5A6 CURRENT LIMITER.
  90. A5A6 CURRENT LIMITER.
  91. A5A6 CURRENT LIMITER.
  92. A5A6 CURRENT LIMITER.
  93. A5A6 CURRENT LIMITER.
  94. A5A6 CURRENT LIMITER.
  95. A5A6 CURRENT LIMITER.
  96. A5A6 CURRENT LIMITER.
  97. A5A6 CURRENT LIMITER.
  98. A5A6 CURRENT LIMITER.
  99. A5A6 CURRENT LIMITER.
  100. A5A6 CURRENT LIMITER.

FUNCTIONAL SCHEMATIC DIAGRAM  
 DC VOLTAGE STANDARD  
 SUPPORT MODULES  
 3328-1002  
 3328-1002  
 111 12 113 1 14  
 JOHN FLUKE MFG. CO. INC.  
 P.O. BOX 1000  
 BAYVIEW, MICHIGAN 48008

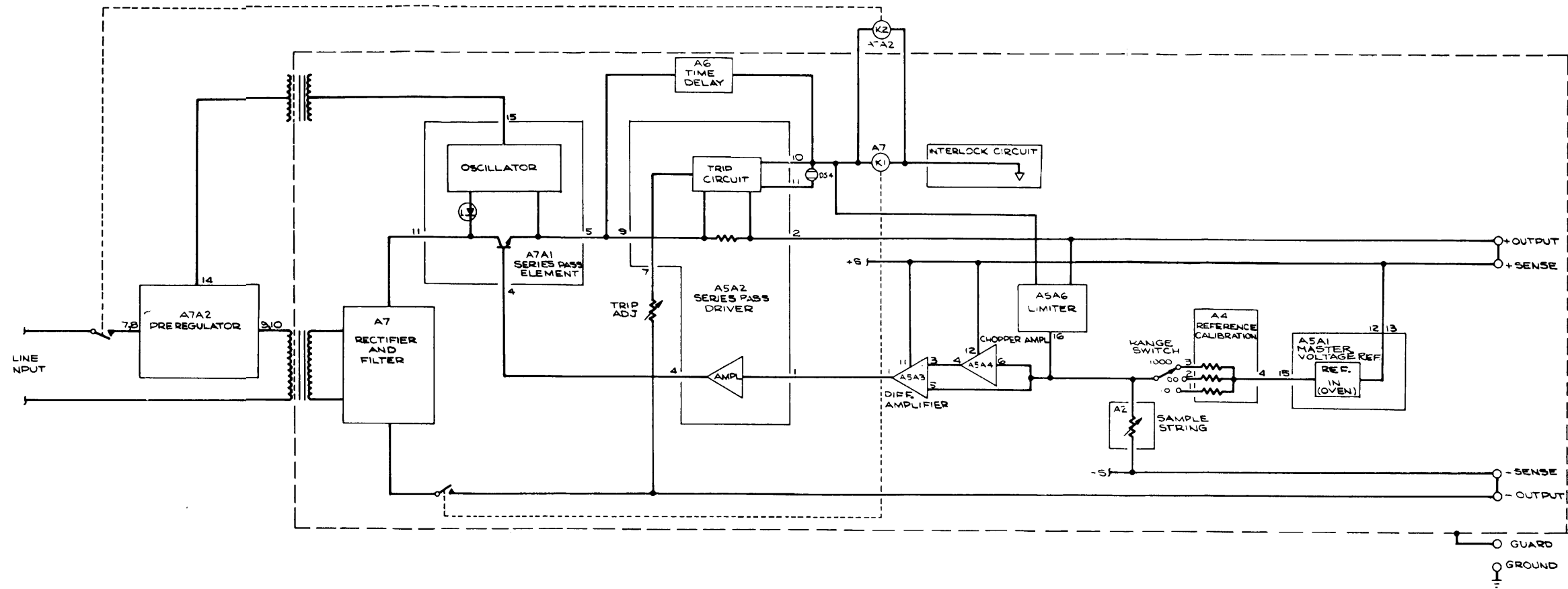

FUNCTIONAL BLOCK DIAGRAM	
MODEL 332B	
DC VOLTAGE STANDARD	
332B-1000	
SER. NO. 123 & ON	REV. <b>b</b>
JOHN FLUKE MFG. CO., INC. P.O. Box 7428 Seattle, Wash. 98122	



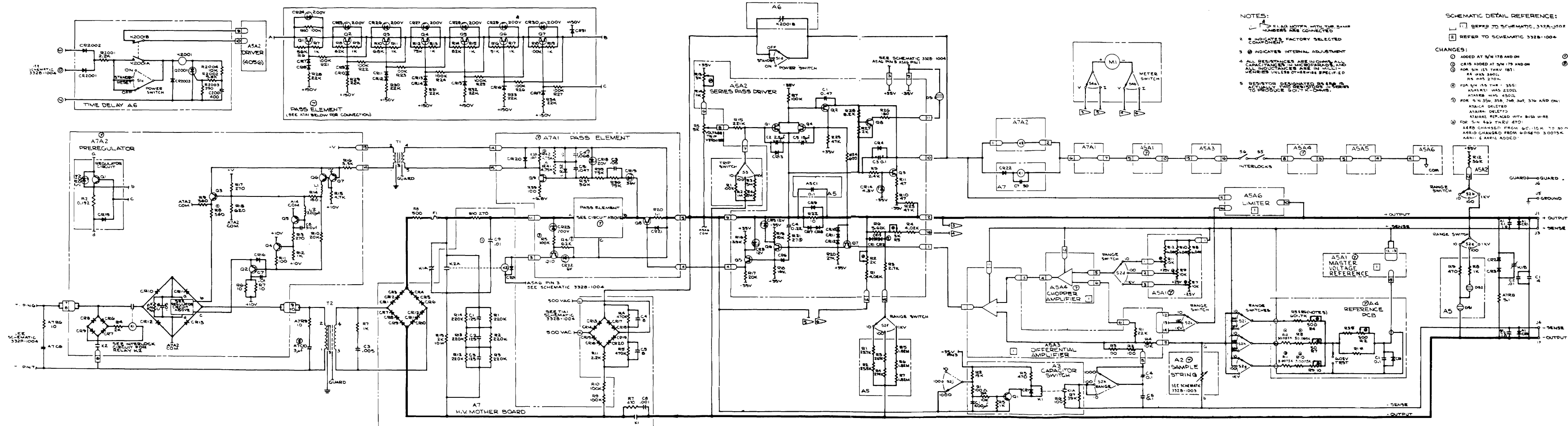

- NOTES:
1. 2-LEAD 500VVA VOLTAGE SENSITIVE TRANSISTORS ARE CONNECTED AS SHOWN.
  2. INDICATES FACTORY SELECTED COMPONENT.
  3. INDICATES INTERNAL ADJUSTMENT.
  4. ALL RESISTANCES ARE IN OHMS UNLESS OTHERWISE SPECIFIED. ALL CAPACITANCES ARE IN FARADS UNLESS OTHERWISE SPECIFIED.
  5. RESISTOR DESIGNATED AS 1% IS TO BE USED TO 0.1% TOLERANCE.

- SCHEMATIC DETAIL REFERENCE:
- 1 REFER TO SCHEMATIC 332A-100A
  - 2 REFER TO SCHEMATIC 332B-100A

- CHANGES:
- 1 ADDED AT 3/4 178 AND ON
  - 2 CR15 ADDED AT 3/4 179 AND ON
  - 3 FOR 3/4 181 THRU 187: R4 WAS 270K R5 WAS 270K
  - 4 FOR 3/4 188 THRU 195: A7A1 WAS 220L A7A2 WAS 450L
  - 5 FOR 3/4 196 THRU 201: A7A1 WAS 220L A7A2 WAS 450L
  - 6 A7A1A DELETED A7A1A DELETED A7A1A RE-PCD WITH BUS WIRE
  - 7 FOR 3/4 182 THRU 170: R4B CHANGED FROM 50K TO 15K TO 30% R4C CHANGED FROM 10K TO 300K R4D: 1% R4E ADDED

- 1 MONKIED ASSEMBLY ON 332B/AP
- 2 ATC10 CHANGED TO 1UF ON 332B/AP

FUNCTIONAL SCHEMATIC DIAGRAM	
DC VOLTAGE STANDARD	
332B-1001	
REVISED BY: [initials]	DATE: [date]
BY: [initials]	DATE: [date]
JOHN FLUKE MFG. CO., INC.	
P.O. BOX 7000, BURLINGAME, CALIF. 94010	

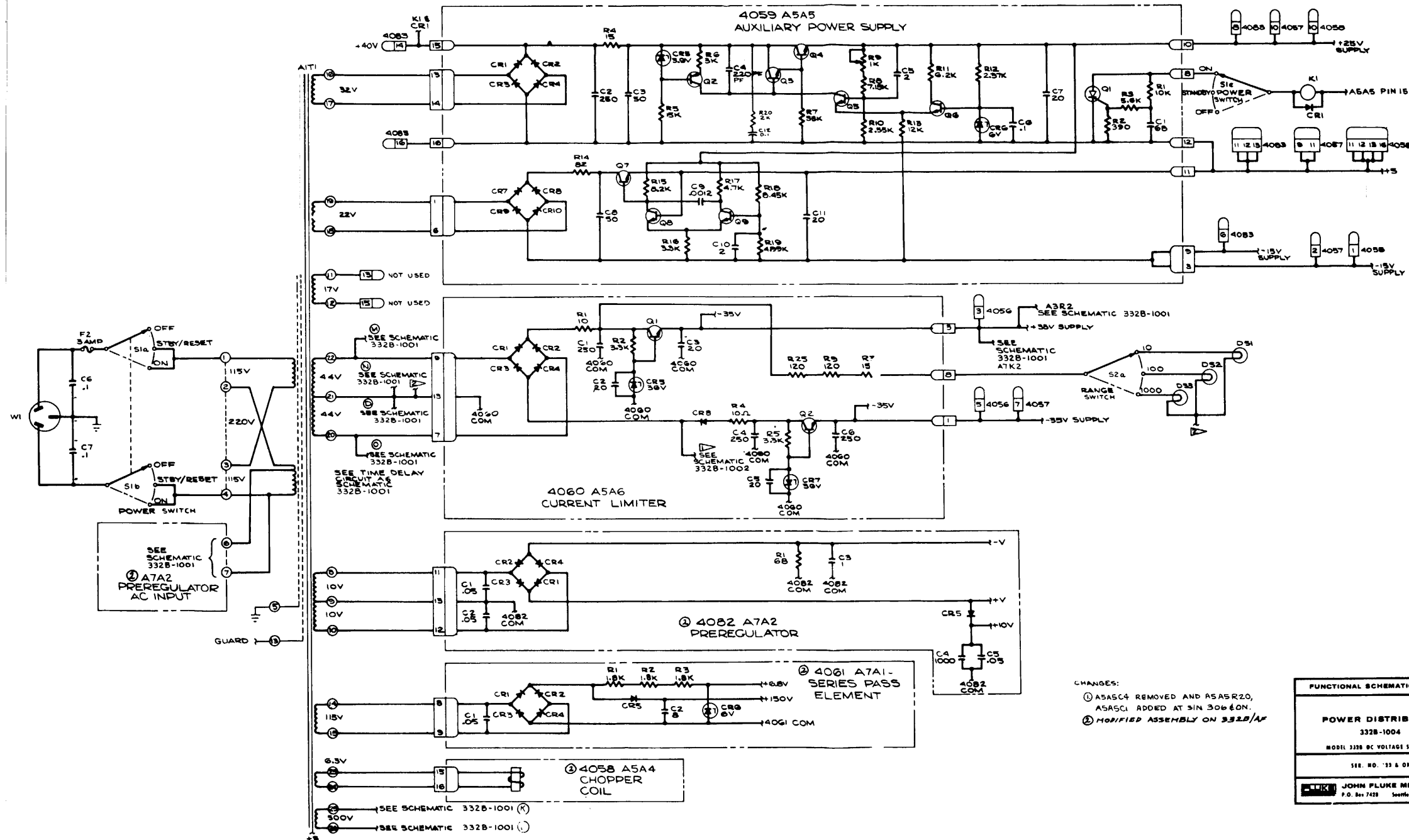

CHANGES:  
 ① A5A5C4 REMOVED AND A5A5R20, A5A5C1 ADDED AT SIN 306 & ON.  
 ② MODIFIED ASSEMBLY ON 332B/AF

FUNCTIONAL SCHEMATIC DIAGRAM	
POWER DISTRIBUTION	
332B-1004	
MOD. 332B DC VOLTAGE STANDARD	
SIB. NO. 33 & ON	REV. C
JOHN FLUKE MFG. CO., INC. P.O. Box 7428 Seattle, Washington 98138	

RECOMMENDED CHANGES TO EQUIPMENT TECHNICAL PUBLICATIONS



THEN... JOT DOWN THE DOPE ABOUT IT ON THIS FORM. CAREFULLY TEAR IT OUT, FOLD IT AND DROP IT IN THE MAIL!

**SOMETHING WRONG WITH THIS PUBLICATION?**

FROM: (PRINT YOUR UNIT'S COMPLETE ADDRESS)

DATE SENT

PUBLICATION NUMBER

PUBLICATION DATE

PUBLICATION TITLE

BE EXACT... PIN-POINT WHERE IT IS

PAGE NO.	PARA-GRAPH	FIGURE NO.	TABLE NO.

IN THIS SPACE TELL WHAT IS WRONG AND WHAT SHOULD BE DONE ABOUT IT:

TEAR ALONG PERFORATED LINE

PRINTED NAME, GRADE OR TITLE, AND TELEPHONE NUMBER

SIGN HERE:

DA FORM 2028-2  
1 JUL 79

PREVIOUS EDITIONS ARE OBSOLETE.

P.S.—IF YOUR OUTFIT WANTS TO KNOW ABOUT YOUR RECOMMENDATION MAKE A CARBON COPY OF THIS AND GIVE IT TO YOUR HEADQUARTERS.

**PIN NO: 008568-000**